



Intelligent Traffic Camera

User Manual

Version: V1.0

Date: 2022-11-23

Chapter 1. Introduction.....	5
1.1 Copyright Statement.....	5
1.2 Safety Instruction.....	5
1.3 Revision History.....	6
Chapter 2. Entrance and Exit Management.....	7
2.1 Product Description.....	7
2.1.1 Product Overview.....	7
2.1.2 Related Product.....	7
2.1.3 Hardware Overview.....	7
2.1.4 Related Documents.....	9
2.2 Configuration Flow.....	9
2.3 Network Connection.....	11
Setting the Camera over the LAN.....	11
Dynamic IP Connection.....	11
2.4 Accessing the Network Camera.....	12
Assigning an IP Address.....	12
Accessing from the Web Browser.....	19
Accessing from Milesight Back-end Software.....	20
2.5 Live View.....	22
Live Video.....	22
LPR Mode.....	26
2.5 Playback.....	29
Playback.....	29
2.6 Settings.....	33
2.6.1 Media.....	33
2.6.2 Network.....	55
2.6.3 Storage.....	75
2.6.4 Event.....	82
2.6.5 LPR.....	90
2.6.6 System.....	121
Chapter 3. Road Traffic Management.....	135
3.1 Product Description.....	135

3.1.1 Product Overview.....	135
3.1.2 Related Product.....	135
3.1.3 Hardware Overview.....	136
3.1.4 Related Documents.....	139
3.2 Configuration Flow.....	139
3.3 Network Connection.....	141
Setting the Camera over the LAN.....	141
Dynamic IP Connection.....	141
3.4 Accessing the Network Camera.....	142
Assigning an IP Address.....	142
Accessing from the Web Browser.....	149
Accessing from Milesight Back-end Software.....	150
3.5 Live View.....	152
Live Video.....	152
PTZ Mode.....	156
LPR Mode.....	163
3.6 Playback.....	167
Playback.....	167
3.7 Settings.....	171
3.7.1 Media.....	171
3.7.2 Network.....	193
3.7.3 Storage.....	213
3.7.4 Event.....	220
3.7.5 LPR.....	240
3.7.6 System.....	285
Chapter 4. Parking Management.....	299
4.1 Product Description.....	299
4.1.1 Product Overview.....	299
4.1.2 Related Product.....	299
4.1.3 Hardware Overview.....	299
4.1.4 Benefits of the Camera.....	300
4.1.5 Installation Guide.....	301

4.1.6 Related Documents.....	304
4.2 Configuration Flow.....	305
4.3 Network Connection.....	306
Setting the Camera over the LAN.....	306
Dynamic IP Connection.....	307
4.4 Accessing the Network Camera.....	307
Assigning an IP Address.....	307
Accessing from the Web Browser.....	314
4.5 Live View.....	315
Live Video.....	315
4.6 Playback.....	318
Playback.....	318
4.7 Settings.....	321
4.7.1 Media.....	321
4.7.2 Network.....	341
4.7.3 Storage.....	361
4.7.4 Event.....	368
4.7.5 System.....	386
Chapter 5. Services.....	399

Chapter 1. Introduction

Thank you for purchasing our product. If there is any question or request, please do not hesitate to contact your dealer.

This manual may contain several technically incorrect places or printing errors, and the content is subject to change without notice. The updates will be added into the new version of this manual. We will readily improve or update the products or procedures described in the manual.

This Manual explains how to use and manage Milesight Intelligent Traffic cameras. Milesight innovatively combines video surveillance with AI, ANPR, 3D Radar and other cutting-edge technologies to perfectly meet the demands of road traffic management, entrance & exit management and indoor & outdoor management. So the Milesight Intelligent Traffic camera consists of three series, including Entrance & Exit Management, Road Traffic Management, Parking Management. Please read this manual carefully before operation and retain it for future reference.

You can also click on the following hyperlinks to quickly jump to the corresponding series introduction.

1. [Entrance & Exit Management \(page 7\)](#)
2. [Road Traffic Management \(page 135\)](#)
3. [Parking Management \(page 299\)](#)

1.1 Copyright Statement

This manual may not be reproduced in any form or by any means to create any derivative such as translation, transformation, or adaptation without the prior written permission of Xiamen Milesight IoT Co., Ltd (Hereinafter referred to as Milesight).

Milesight reserves the right to change this manual and the specifications without prior notice. The latest specifications and user documentation for all Milesight products are available on our official website <http://www.milesight.com>

1.2 Safety Instruction

These instructions are intended to ensure that user can use the product correctly to avoid danger or property loss. The precaution measures are divided into “Warnings” and “Cautions”

Warnings: Serious injury or death may be caused if any of these warnings is neglected.

- This installation must be conducted by a qualified service person and should strictly comply with the electrical safety regulations of the local region
- To avoid risk of fire and electric shock, do keep the product away from rain and moisture before installed.
- Do not touch components such as heat sinks, power regulators, and processors, which may be hot
- Source with DC/AC 12V or PoE
- Please make sure the plug is firmly inserted into the power socket
- When the product is installed on a wall or ceiling, the device should be firmly fixed
- If the product does not work properly, please contact your dealer. Never attempt to disassemble the camera by yourself

Cautions: Injury or equipment damage may be caused if any of these cautions are neglected.

- Make sure that the power supply voltage is correct before using the camera
- Do not store or install the device in extremely hot or cold temperatures, dusty or damp locations, and do not expose it to high electromagnetic radiation
- Only use components and parts recommended by manufacturer
- Do not drop the camera or subject it to physical shock
- To prevent heat accumulation, do not block air circulation around the camera
- Laser beams may damage image sensors. The surface of image sensors should not be exposed to where a laser beam equipment is used
- Use a blower to remove dust from the lens cover
- Use a soft, dry cloth to clean the surface of the camera. Stubborn stains can be removed using a soft cloth dampened with a small quantity of detergent solution, then wipe dry
- Do not use volatile solvents such as alcohol, benzene or thinners as they may damage the surface finishes
- Save the package to ensure availability of shipping containers for future transportation

1.3 Revision History

Table 1.

Version	Revision Content	Release Date
V1.0	First release	November 2022

Chapter 2. Entrance and Exit Management



2.1 Product Description

2.1.1 Product Overview

Milesight Entrance & Exit Management Camera combines video surveillance with AI, ANPR and other cutting-edge technologies to help traffic management systems intelligently monitor and manage traffic behavior at entrances and exits. Based on real-time data, valuable insights are obtained to optimize the traffic flow at the entrance and exit, reduce the risk of accidents, and deal with emergencies more efficiently. It can be widely used in the security gate system, which can significantly improve management efficiency and make traffic more intelligent, safer and smoother.

2.1.2 Related Product

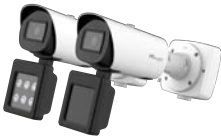
Table 2.

Product	Name
	Entrance & Exit AI LPR Bullet Camera
	Entrance & Exit Supplement Light AI LPR Pro Bullet Plus Camera
	Entrance & Exit AI LPR Pro Dome Camera

2.1.3 Hardware Overview

- Entrance & Exit AI LPR Bullet Camera

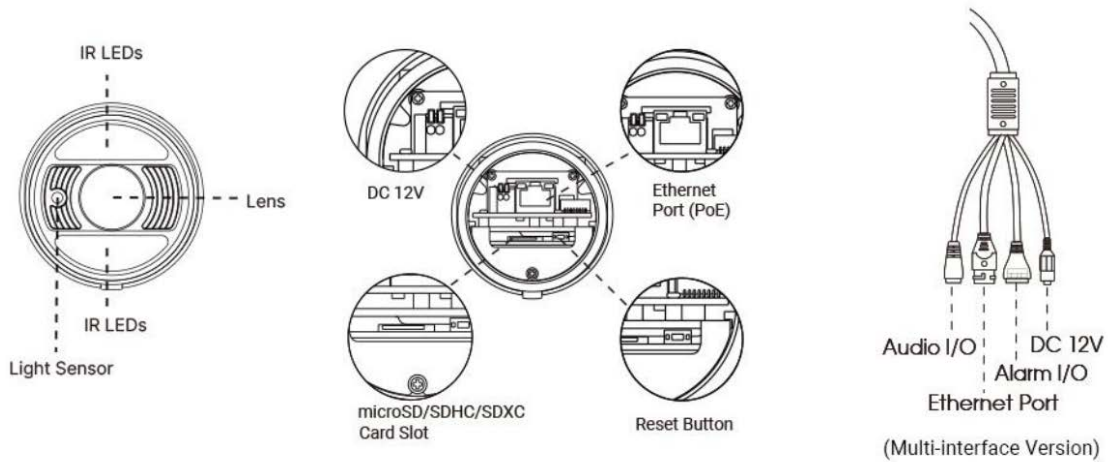

• Entrance & Exit Supplement Light AI LPR Pro Bullet Plus Camera

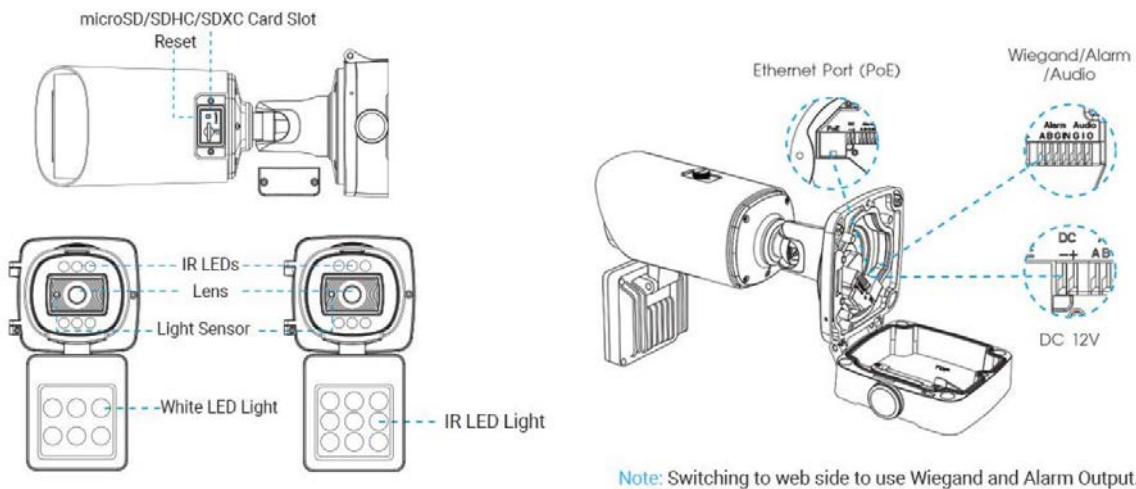

• Entrance & Exit AI LPR Pro Dome Camera

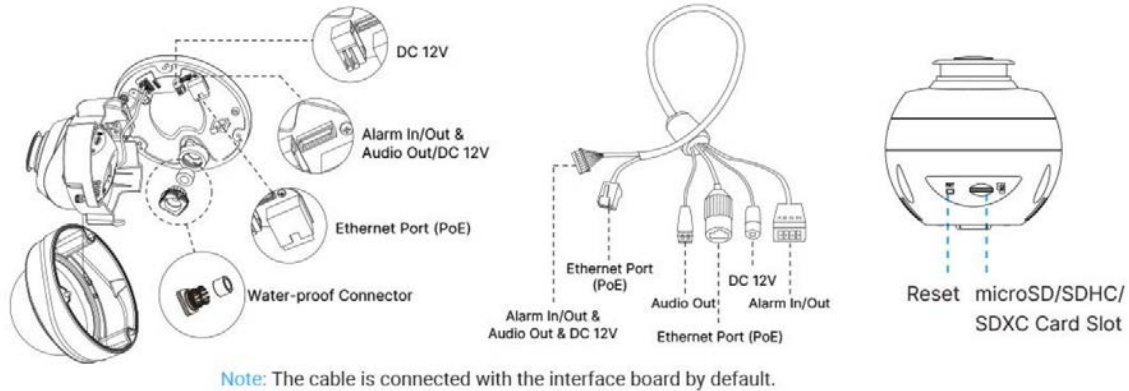

2.1.4 Related Documents

Table 3.

Document Type	Link
Entrance&Exit Management Camera	
Datasheet	https://www.milesight.com/static/file/en/download/datasheet/ipc/traffic/Milesight-Entrance-and-Exit-Management-Datasheet-en.pdf
Quick Start Guide	https://www.milesight.com/static/file/en/download/user-manual/ipc/Milesight-Network-Camera-Quick-Start-Guide.pdf

2.2 Configuration Flow

The configuration flow of Entrance&Exit Management Camera is shown in the following figure.

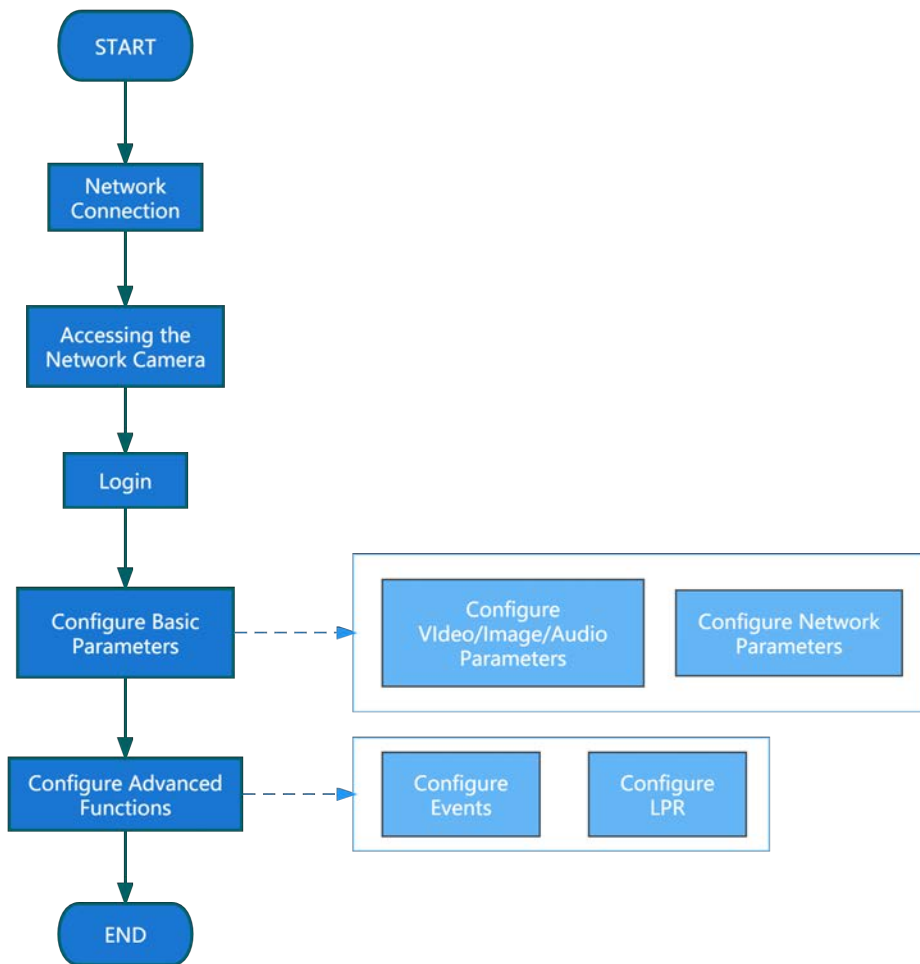

More configuration details are shown in the following table.

Table 4. Description of flow

Configuration	Description	Reference
Network Connection	Connect the network camera. You can set the camera over the LAN or dynamic IP connection.	Setting the Camera over the LAN (page 11)
Accessing the Network Camera	Accessing from IP address, web browser and Milesight back-end software are available.	Assigning an IP Address (page 12)
Configure Basic Parameters	After login the camera, you can adjust the video/image/audio/network parameters as needed.	Video (page 33) Image (page 36)
Configure Advanced Functions	Configure LPR-related settings and other advanced functions.	General (page 90)

2.3 Network Connection

Setting the Camera over the LAN

Connecting the camera to a switch or a router is the most common connection method. The camera must be assigned an IP address that is compatible with its LAN.

Connect the Camera to the PC Directly

In this method, only the computer connected to the camera will be able to view the camera. The camera must be assigned a compatible IP address to the computer. Details are shown as the following figure.



Connect via a Switch or a Router

Refer to the following figure to set network camera over the LAN via the switch or router.

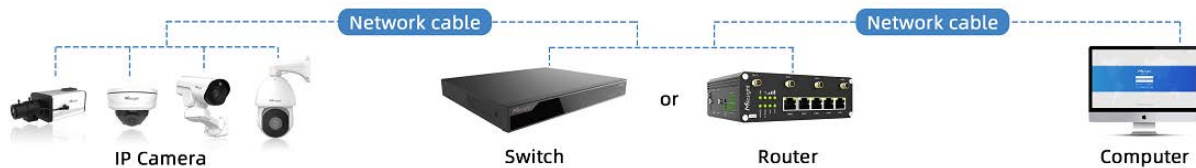

Dynamic IP Connection

Step1: Connect the network camera to a router;

Step2: On the camera, assign a LAN IP address, the Subnet mask and the Gateway;

Step3: On the router, set port forwarding. E.g. 80, 8000 and 554 ports. The steps for port forwarding vary depending on different routers. Please look up the router's user manual for assistance with port forwarding;

Step4: Apply a domain name from a domain name provider;

Step5: Configure the DDNS settings in the setting interface of the router;

Step6: Visit the camera via the domain name.

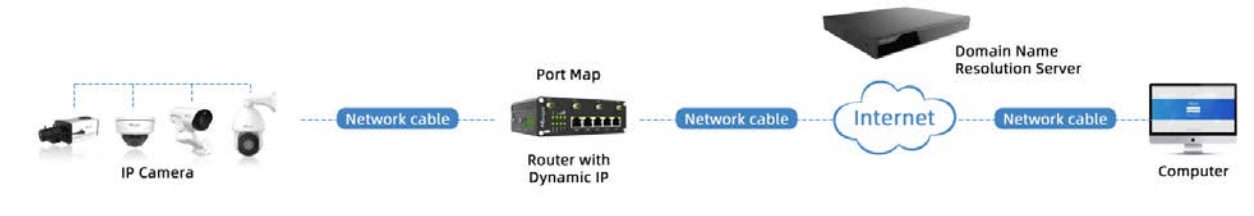

2.4 Accessing the Network Camera

Assigning an IP Address

The Network Camera must be assigned an IP address to be accessible. The default IP address of Milesight network cameras is 192.168.5.190.

You can also change the IP address of the camera via Smart Tools or browser. Please connect the camera in the same LAN of your computer.

Assigning an IP Address Using Smart Tools

Smart Tools is a software tool which can automatically detect multiple online Milesight network cameras in the LAN, set IP addresses, and manage firmware upgrades. It's recommended to use when assigning IP addresses for multiple cameras.

Step1: Install Smart Tools (The software could be downloaded from our website);

Step2: Start Smart Tools, click the IPC Tools page, then enter the device information, such as IP address, MAC address, Status, Port number, Netmask, and Gateway, then all related Milesight network camera in the same network will be displayed. Details are shown as the figure below;

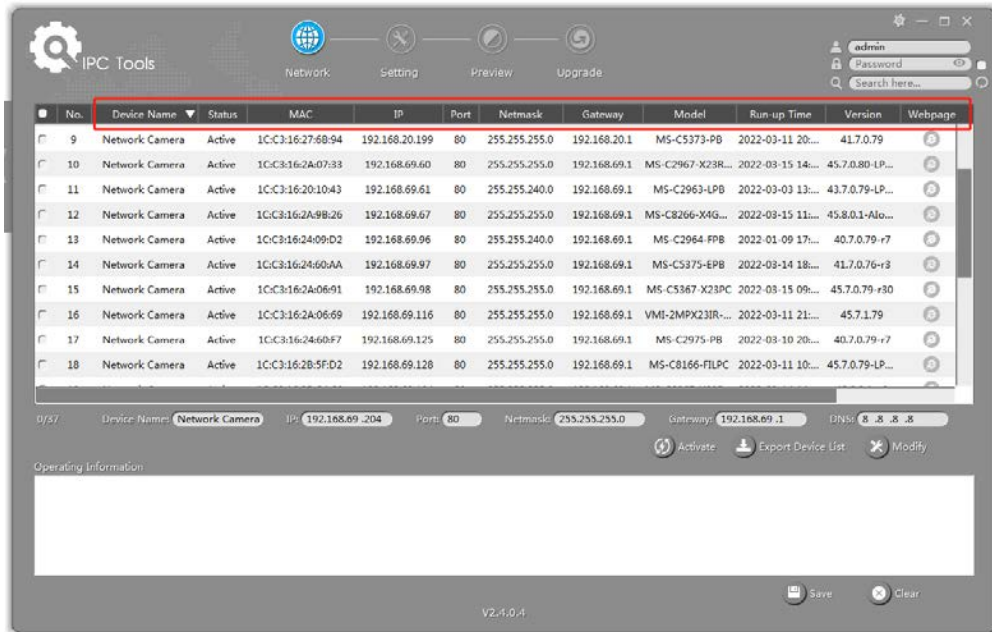

Step3: Select a camera or multiple cameras according to the MAC addresses;

Select single camera:

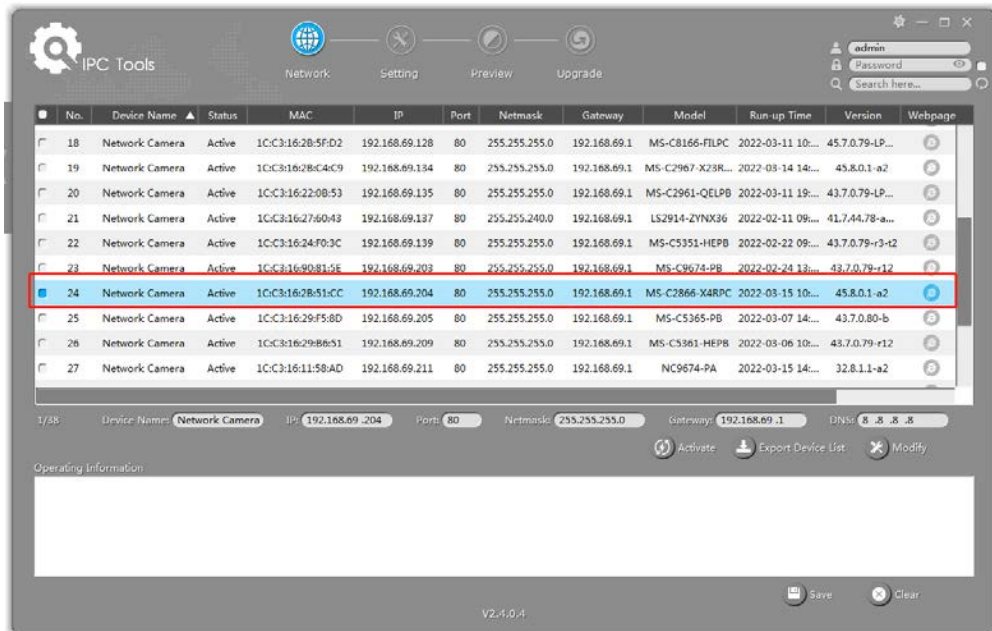

Select multiple cameras:

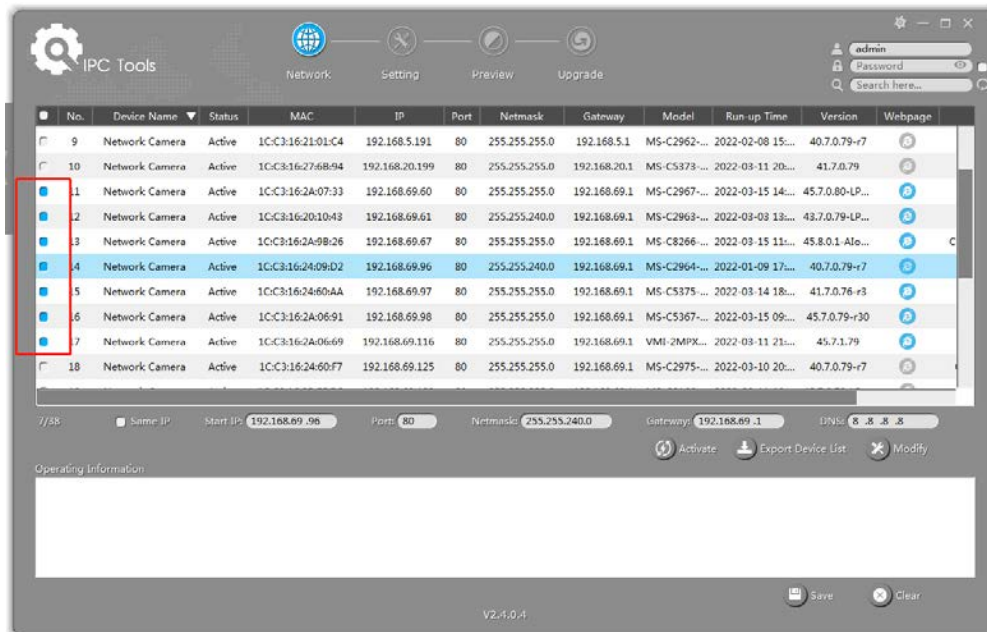

Step4: If the selected camera shows "Inactive" in the status bar, click "Activate" to set the password when using it for the first time. You can also set the security questions when activating the camera in case that you forget the password (You can reset the password by answering three security questions correctly). Click 'Save' and it will show that the activation was successful.

Note:

- Password must be 8 to 32 characters long, contain at least one number and one letter.
- You need to upgrade Smart Tools version to V2.4.0.1 or above to activate the camera.

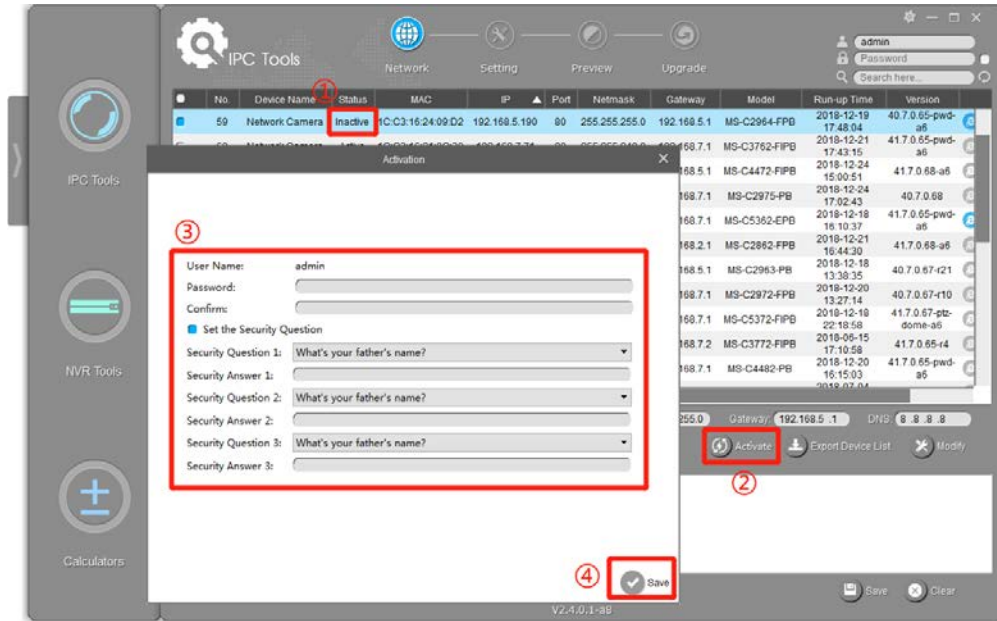

Step5: After activation, you can change the IP address or other network values, and then click “Modify” button.

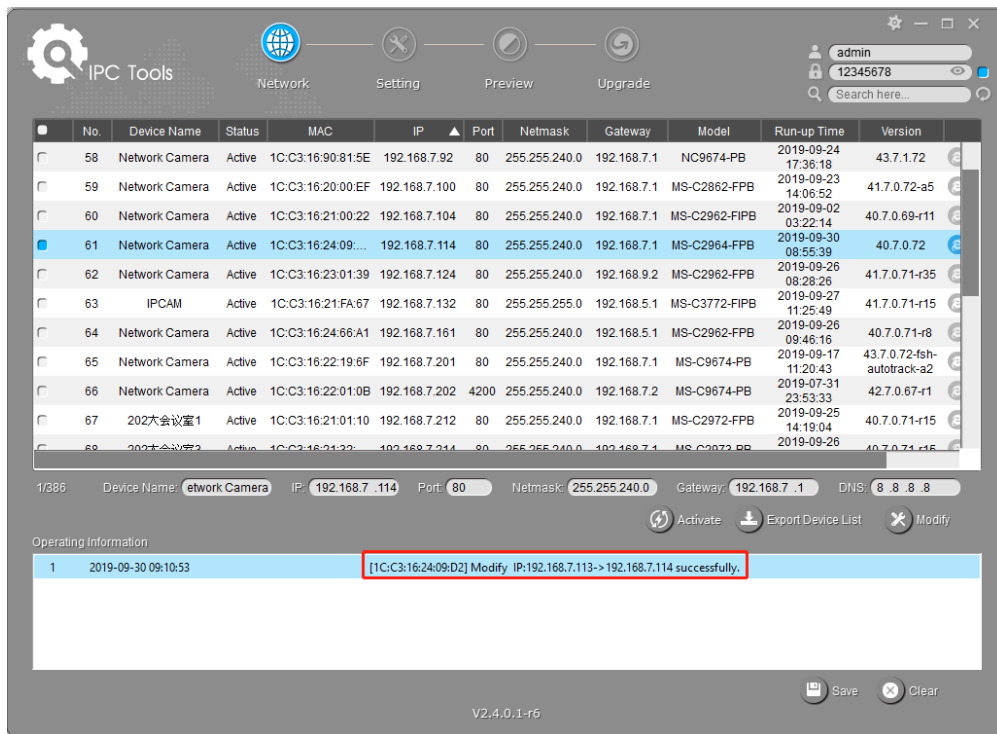

Step6: By double clicking the selected camera or the browser of interested camera, you can access the camera via web browser directly. The Internet Explorer window will pop up.

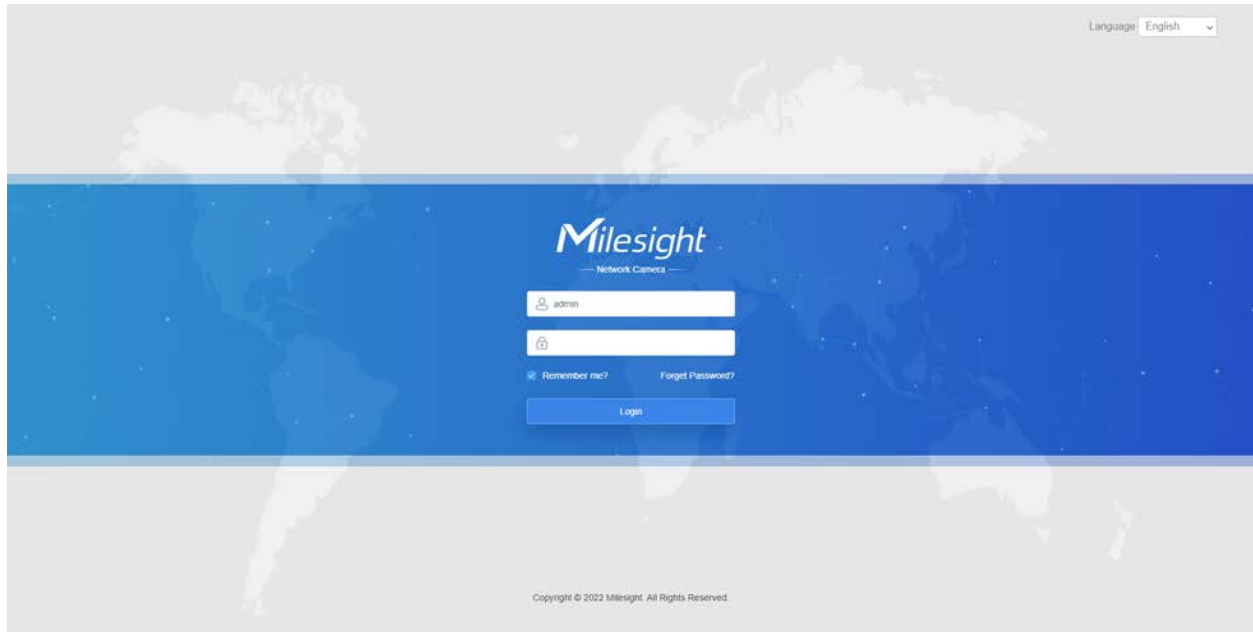

More usage of Smart Tools, please refer to the ***Smart Tools User Manual***.

Assign An IP Address via Browser

If the network segment of the computer and that of the camera are different, please follow the steps to change the IP address:

Step1: Change the IP address of computer to 192.168.5.0 segment, here are two ways as below:

a. Start-->Control Panel-->Network and Internet Connection-->Network Connection-->Local Area Connection, and double click it;

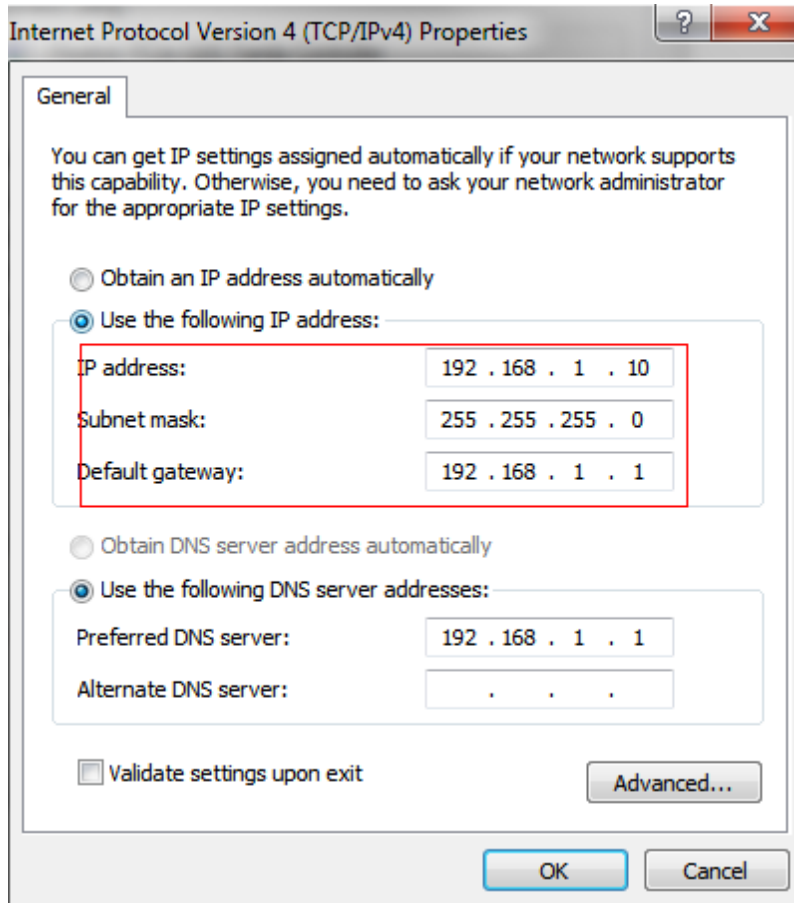

b. Click "Advanced", and then click "IP settings"--> "IP address"--> "Add". In the pop-up window, enter an IP address that in the same segment with Milesight network camera (e.g. 192.168.5.61, but please note that this IP address shall not conflict with the IP address on the existing network);

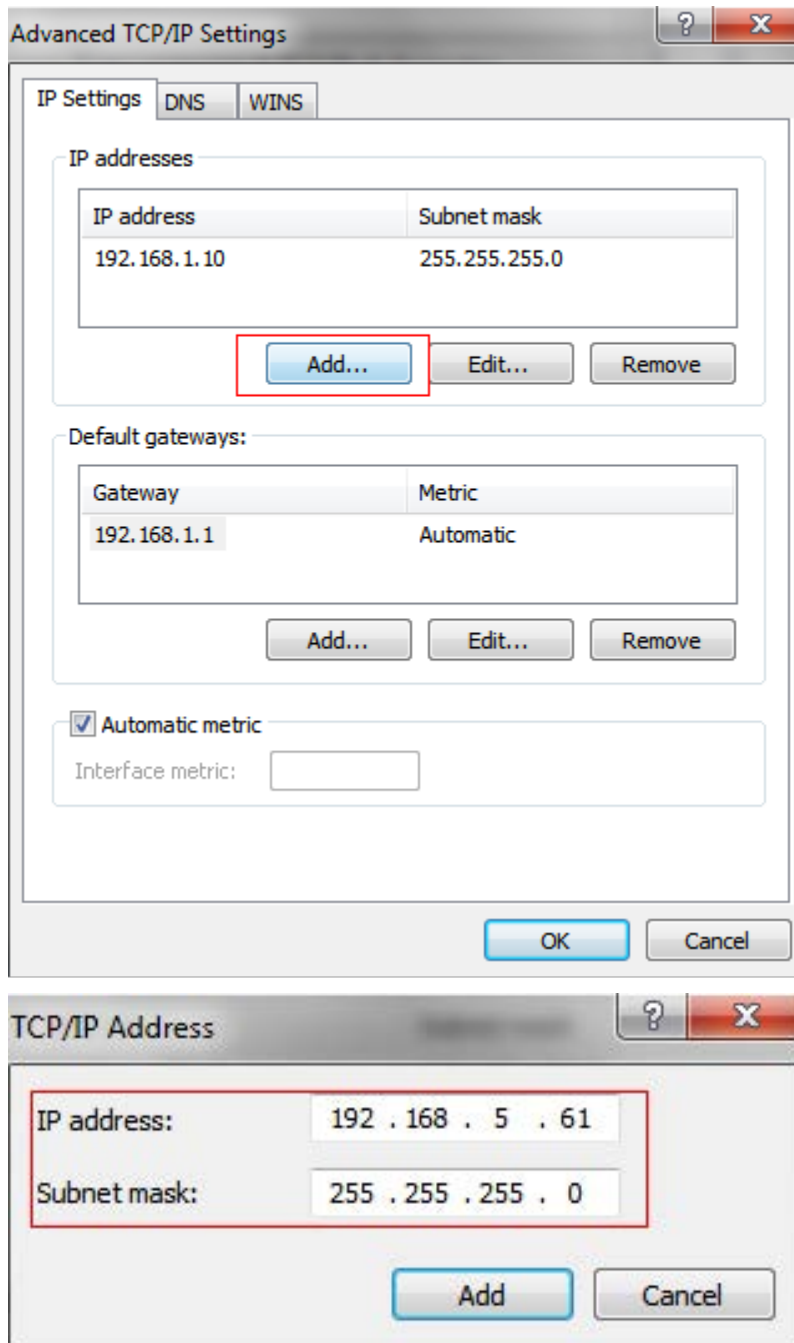

Step2: Start the browser. In the address bar, enter the default IP address of the camera: <http://192.168.5.190>;

Step3: You need to set the password first when using it for the first time. And you can also set three security questions for your device after activation. Then you can log in to the camera with the user name (admin) and a custom password.

 **Note:**

- Password must be 8 to 32 characters long, contain at least one number and one letter.
- You can click the “forget password” in login page to reset the password by answering three security questions when you forget the password, if you set the security questions in advance.

Step4: After login, please select “Settings” --> “Network” --> “Basic” --> “TCP/IP”. The Network Settings page appears (Shown as below Figure);

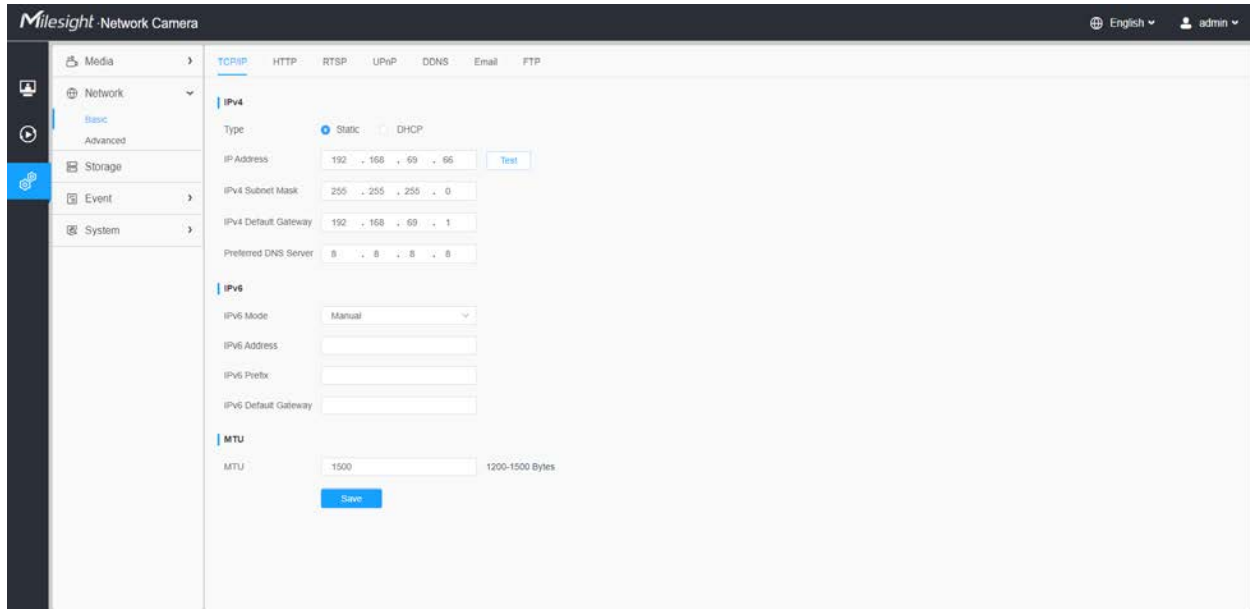

Step5: Change the IP address or other network values. Then click “Save” button;

Step6: The change of default IP address is completed.

Accessing from the Web Browser

The camera can be used with the most standard operating systems and browsers. And the camera was upgraded to support Plugin-Free Mode. In Plugin-Free Mode, you can preview the video on the browser without plugin. Currently Plugin-Free Mode is supported in Firefox & Google Chrome & Safari & Edge browser for Windows system, MAC system, iOS system and Android system. Both H.265&H.264 video codec are supported in Plugin-Free Mode for camera, and it will play the secondary stream by default.

Note:

- For more details about set plugin-free mode of Milesight camera, please refer to <https://milesight.freshdesk.com/a/solutions/articles/69000643388>.

Accessing from Milesight Back-end Software

Accessing from Milesight NVR (Network Video Recorder)

Milesight NVR Series can work with Milesight network cameras. Based on embedded Linux operation system, Milesight NVR Series manages and stores HD video data. It owns multi-disk management systems, front end HD device management system, HD video analysis system and high-capacity system for video. Also, it adopts the technology of high flow capacity data network transmitting&transmission, with multi-channel video decoding, to achieve functions like intelligent management, safe storage, HD decoding, etc.

For detailed information about how to use the Milesight NVR Series, please refer to ***Milesight NVR User Manual***.

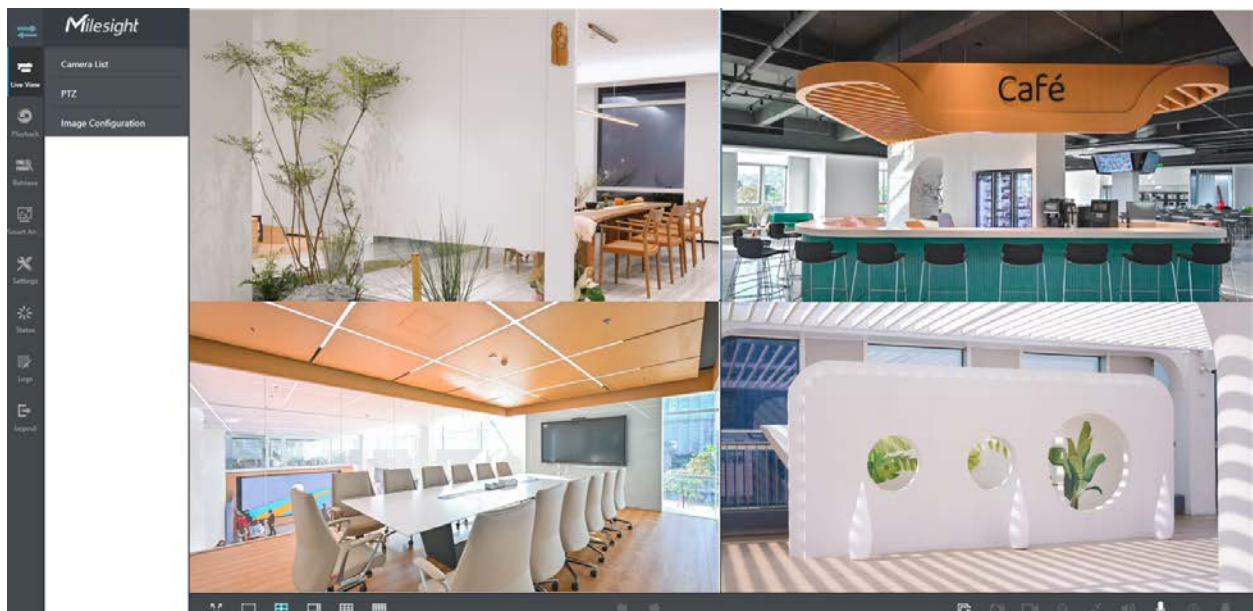

Accessing from Milesight CMS (Center Management System)

Milesight Central Management System (CMS) is a central management system for Milesight network cameras and Milesight NVR. It is an intelligent surveillance solution for users to control up to 256 devices, to remote preview and playback more conveniently. With high-efficient management performance, Milesight CMS software offers users a superior administration experience in such centralized system. Featured with friendly UI design, the intelligent video management system CMS allows users of all levels to setup and deploy solutions as easy as ABC. Moreover, E-map function provides users a smarter way to show the devices spatial distribution. The software could be downloaded from our website <https://www.milesight.com/>.

Please install Milesight CMS; then launch the program to add the camera to the channel list. For detailed information about how to use the software, please refer to ***Milesight CMS User Manual***.

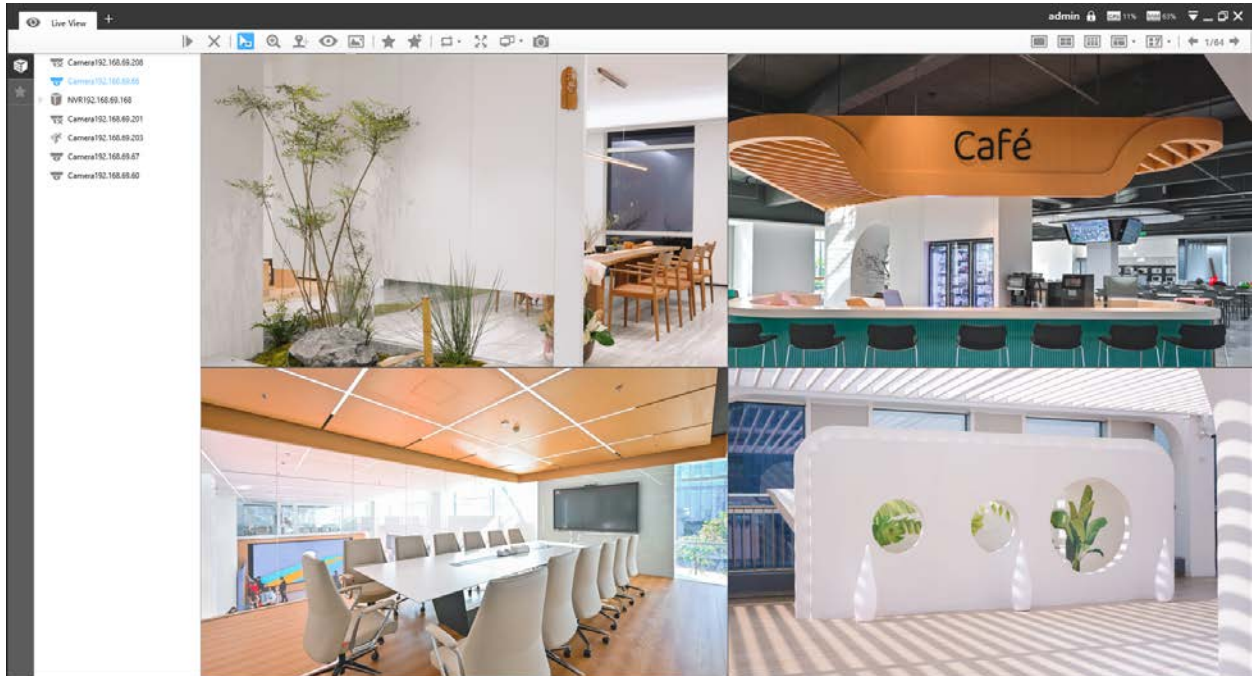

Accessing from Milesight VMS Enterprise (Video Management System)

Milesight VMS Enterprise is a professional and intelligent video management software for businesses. Together with our cameras, it can simplify and freshen up your video surveillance. With advanced C/S architecture, it fulfills your demands and expectations, with rich core functions including live view, record, E-Map, event alarm and smart analysis etc. The software could be downloaded from our website <https://www.milesight.com/>.

Please install Milesight VMS Enterprise; then launch the program to add the camera to the channel list. For detailed information about how to use the software, please refer to ***Milesight VMS Enterprise User Manual***.

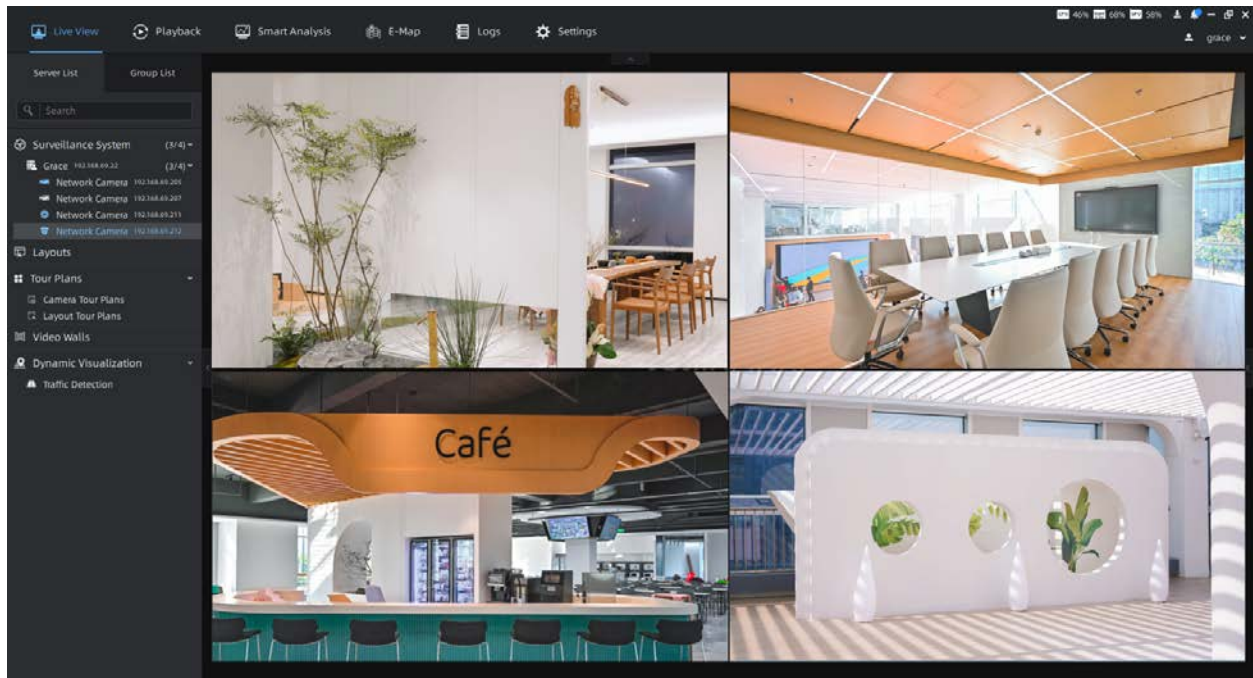

2.5 Live View

Live Video

After logging in the network camera web GUI successfully, user is allowed to view live video as follows.

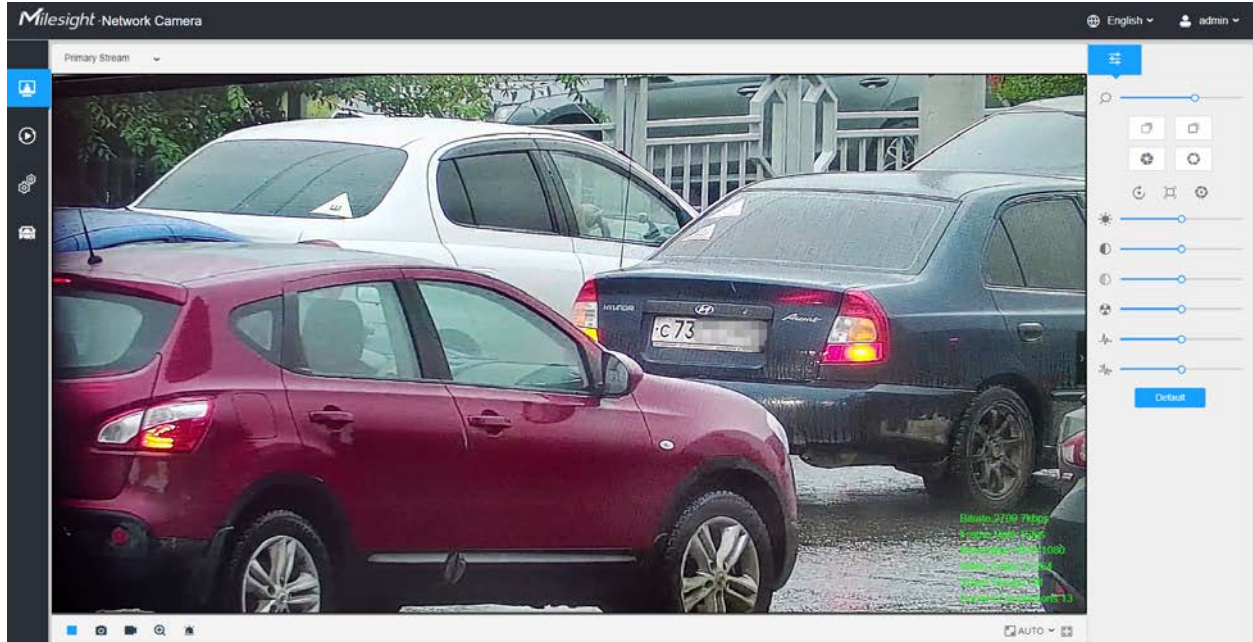



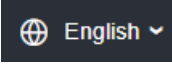
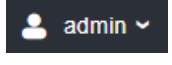
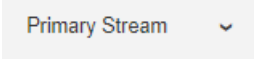

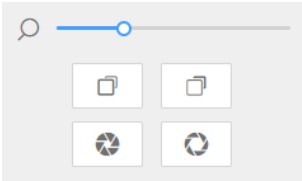



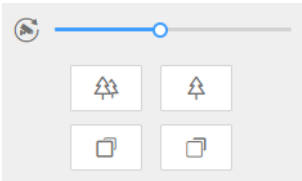





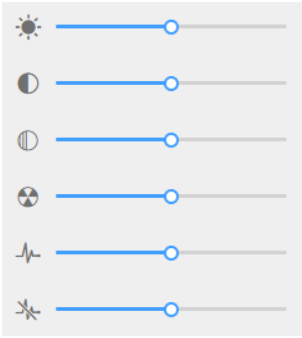

Table 5. Description of the buttons

No.	Parameter	Description
1	 Live Video	Click to access the live view page.
2	 Playback	Click to access the playback page.
3	 Settings	Click to access the configuration page.
4	 LPR Mode	Click to access the LPR Mode.
5	 English ▾	Click to select system language.
6	 admin ▾	Display the user name and click to logout.
7	 Primary Stream ▾	Choose the stream (Primary/Secondary/Tertiary) to show on the current video window.

No.	Parameter	Description
8	 Recording	When recording, the icon appears.
9	 Alarm	When an alarm of Motion Detection was triggered, the icon appears.
10	 Alarm	Except for the kinds of alarms above, when other alarms were triggered, the icon appears.
11	 Stop/Play	Stop/Play live view.
12	 Snapshot	Click to capture the current image and save to the configured path. The default path is: C:\VMS\+-1\ IMAGE-MANUAL.
13	 Start/Stop Recording	Click to Start Recording video and save to the configured path. The default path is C:\VMS\+-1\MS_Record. Click again to Stop Recording .
14	 Digital Zoom	When enabled, you can zoom in a specific area of video image with your mouse wheel.
15	 Manual Output	Manually trigger Camera Alarm Output.
16	 Window Size	Click to display images at a window size.
17	 Full Screen	Click to display images at full-screen.

No.	Parameter	Description
		<p>Zoom: Adjust the Zoom length of the lens.</p> <p> Note: Only work when your camera is equipped with motorized lens.</p>
		<p>Focus-/Focus+: Adjust focus of the lens.</p> <p> Note: Only work when your camera is equipped with motorized lens.</p>
		<p>Focus Speed: To adjust the speed of focus.</p> <p> Note: Only work when your camera is equipped with auto focus lens.</p>
		<p>Zoom-/Zoom+: Click to zoom in and zoom out.</p> <p> Note: Only work when your camera is equipped with auto focus lens.</p>
		<p>Lens Initialization, Auxiliary Focus and Auto Iris.</p> <p> Note:</p> <ul style="list-style-type: none"> • The Auto Iris is turned on by default when your camera is equipped with auto focus lens. • The Auto Iris support turn on/off when your camera is equipped with P-Iris.
		<p>Brightness: Adjust the Brightness of the scene.</p> <p>Contrast: Adjust the color and light contrast.</p> <p>Saturation: Adjust the Saturation of the image. Higher Saturation makes colors appear more "pure" while lower one appears more "wash-out".</p> <p>Sharpness: Adjust the Sharpness of image. Higher Sharpness sharps the pixel boundary and makes the image looks "more clear".</p> <p>2D DNR/3D DNR: Adjust the noise reduction level.</p> <p>Default: Restore brightness, contrast and saturation to default settings.</p>

LPR Mode

Milesight LPR Camera supports professional LPR Live View interface , it can show the real-time license plate recognition results and display the snapshots of detected license plates ,which realizes a stand-alone LPR solution.

After logging in the LPR network camera web GUI successfully, users can click to access the LPR Mode page, which is shown as follows.

No.	License Plate	Snapshot	Plate Type	Plate Color	Vehicle Type	Vehicle Color	Speed	Direction	Detection Region	Time	Operation
11	AA802TN		Visitor	White	Car	White	113km/h	↓ Approach	1	2022-11-22 06:55:31	🔍 🗑️
10	AB0K		Visitor	White	SUV	Black	77km/h	↓ Approach	1	2022-11-22 06:55:29	🔍 🗑️
9	A...		Visitor	White	SUV	Black	74km/h	↓ Approach	2	2022-11-22 06:55:25	🔍 🗑️
8	AE		Visitor	White	SUV	White	81km/h	↓ Approach	2	2022-11-22 06:55:24	🔍 🗑️
7	AB		Visitor	White	Car	Black	81km/h	↓ Approach	2	2022-11-22 06:55:23	🔍 🗑️
6	A...		Visitor	White	Truck	Yellow	62km/h	↓ Approach	1	2022-11-22 06:55:23	🔍 🗑️
5	AS		Visitor	White	Car	Black	78km/h	↓ Approach	1	2022-11-22 06:55:23	🔍 🗑️
4	AA		Visitor	White	SUV	Black	148km/h	↓ Approach	1	2022-11-22 06:55:17	🔍 🗑️

Left Panel: Live View interface of LPR cameras.

Right Panel: Snapshots of the real-time vehicle and display the information of the vehicle according to the snapshot.

Bottom Panel: Display the information of the vehicles recently detected.

Note:

- The Speed can only be detected by Radar LPR network cameras.
- Vehicles without license plates will be detected and captured by the cameras in real-time, and the recognition results will be recorded as "No Plates".

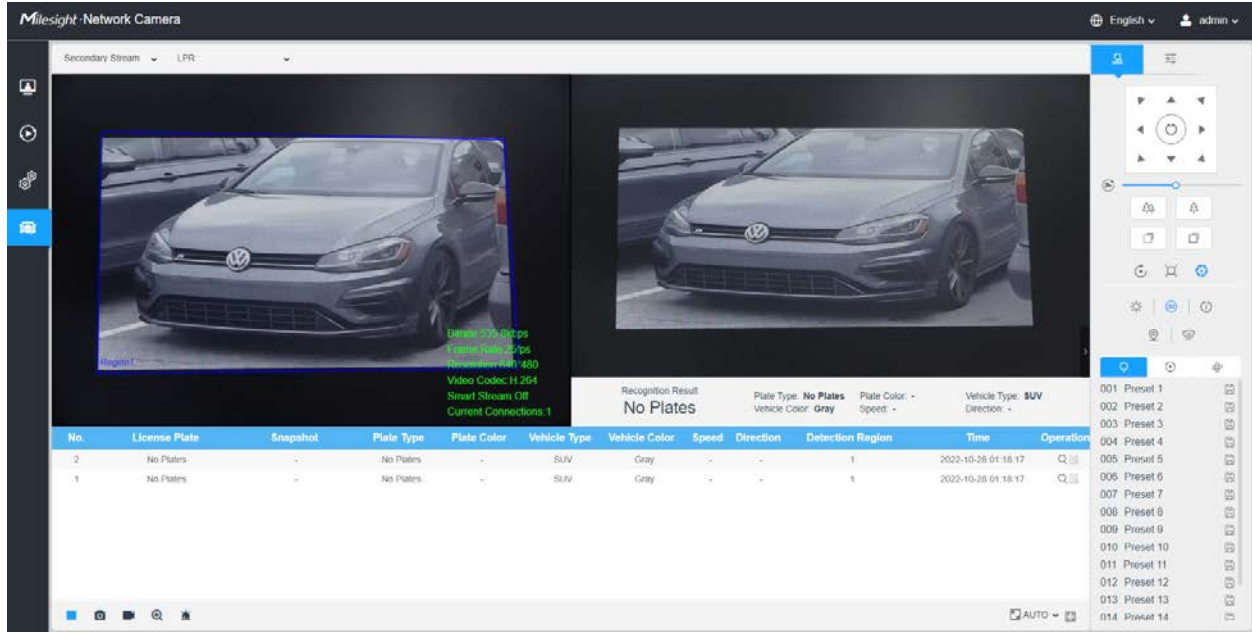



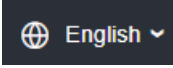
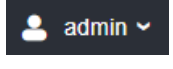
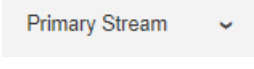









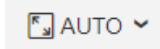





Table 6. Description of the buttons

	Parameter	Description
1	 Live Video	Click to access the live view page.
2	 Playback	Click to access the playback page.
3	 Settings	Click to access the configuration page.
4	 LPR Mode	Click to access the LPR Mode page.
5	 English ▾	Click to select system language.
6	 admin ▾	Display the user name and click to logout.
7	 Primary Stream ▾	Choose the Stream (Primary/Secondary/Tertiary) to show on the current video window.

	Parameter	Description
8		<p>Choose the options (Hide Detection Region/LPR) to hide/show detection region on the current video window.</p> 
9	 <p>Stop/Play</p>	<p>Stop/Play live view.</p>
10	 <p>Alarm</p>	<p>When the Black List license plates passing by, the icon appears.</p>
11	 <p>Alarm</p>	<p>When the White List license plates passing by, the icon appears.</p>
12	 <p>Alarm</p>	<p>When the Visitor license plates passing by, the icon appears.</p>
13	 <p>Snapshot</p>	<p>Click to capture the current image and save to the configured path. The default path is: C:\VMS\+-1\ IMAGE-MANUAL.</p>
14	 <p>Start/Stop Recording</p>	<p>Click to Start Recording video and save to the configured path. Click again to stop recording. The default path is C:\VMS\+-1\MS_Record. Click again to Stop Recording.</p>
15	 <p>Digital Zoom</p>	<p>When enabled, you can zoom in a specific area of video image with your mouse wheel.</p>
16	 <p>Manual Output</p>	<p>Manually trigger Camera Alarm Output.</p>

	Parameter	Description
17	 Window Size	Click to display images at a window size.
18	 Full Screen	Click to display images at full-screen.
Operation		Click to view selected license plate with a large picture.
Operation		Click to add the selected license plate to White/Black List. <div data-bbox="776 699 1377 947" style="border: 1px solid #ccc; padding: 10px; margin-top: 10px;"> <div style="background-color: #007bff; color: white; padding: 5px; display: flex; justify-content: space-between; align-items: center;"> Add × </div> <div style="margin-top: 10px;"> <p>License Plate <input type="text" value="ODA3334"/></p> <p>Type <input style="border: none; border-bottom: 1px solid #ccc;" type="text" value="Black List"/></p> <p style="text-align: right;"> <input type="button" value="Save"/> <input type="button" value="Cancel"/> </p> </div> </div>

2.5 Playback

Playback

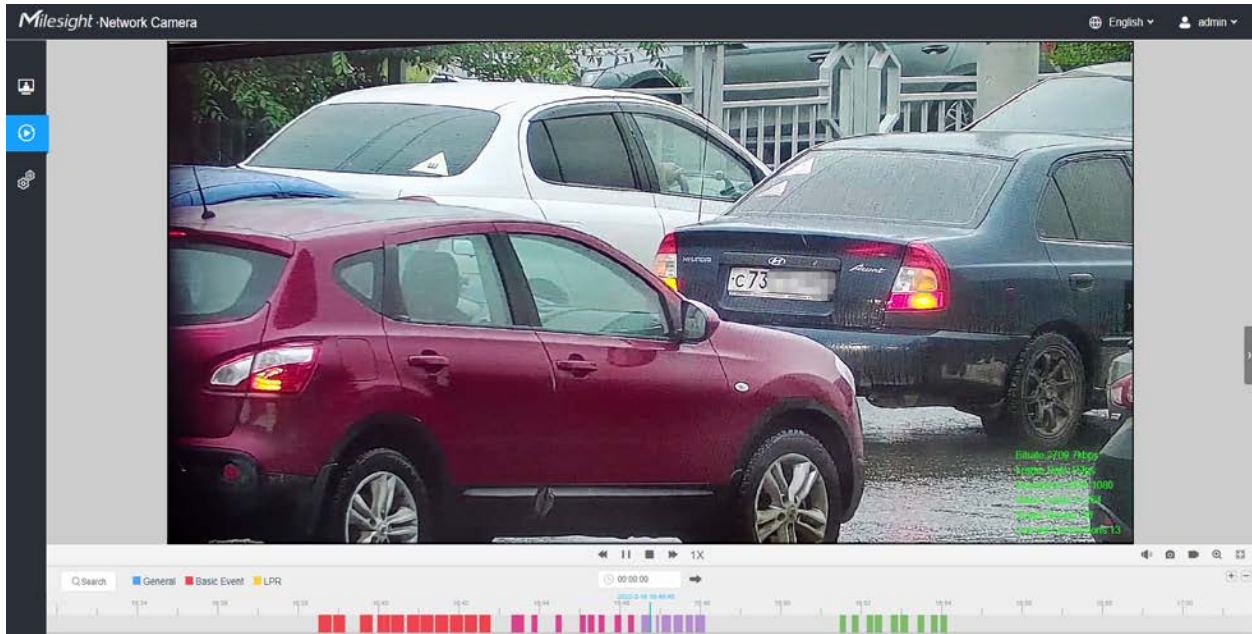

Click  to enter playback interface. In this part, you can search and playback the recorded video files stored in SD cards or NAS. The Playback interface is as below:

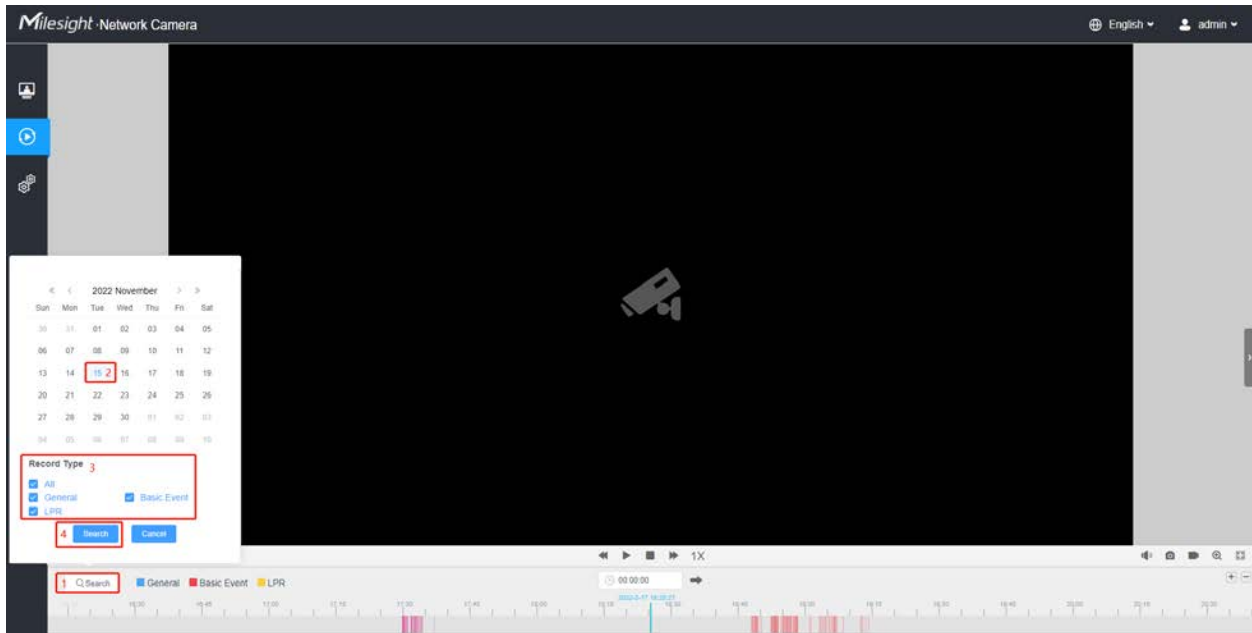

Step1: Click the “Search” button, choose the data and record type when the window pops up.



Step2: The timeline displays the video files for the day and show different colors according to selected record type. Drag the progress bar with the mouse to locate the exact playback point as needed.

Note: You can also input the time and click  to locate the playback point in the filed. You can also click   to zoom out/in the progress bar.

Step3: Click  to play the video files found on this date. The toolbar on the button of playback interface can be used to control playing progress.

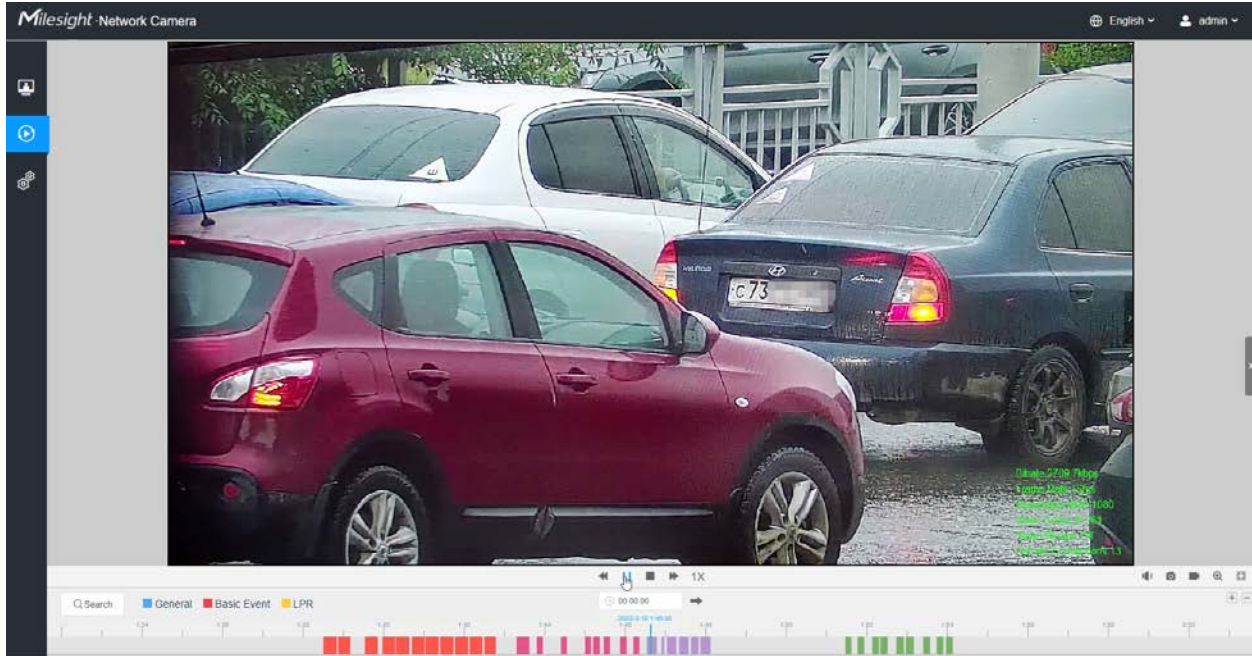
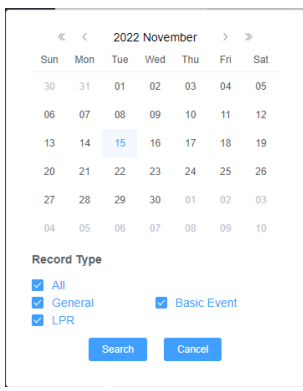
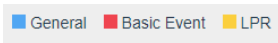



Table 7. Description of the buttons

No.	Parameter	Description
		<p>For LPR camera, the record type include All/General/Basic Event/LPR. The timeline will show different colors according to selected record type as below:</p> <p></p>
1	 <p>Speed Down/Speed Up/Speed</p>	<p>Adjust the speed of video playback.</p> <p>Speed Down: Includes 0.5X and 0.25X for Play.</p> <p>Speed Up: Includes 2X and 4X for Play.</p> <p>Speed: The default playback speed is 1X</p>











No.	Parameter	Description
2	 Play/Pause	Play/Pause the video.
3	 Stop	Stop the video.
4	 Search Time	Select the time that want to locate.
5	 Jump	Go To.

Table 8. Description of the buttons

No.	Parameter	Description
1	 Mute	Click to enable the audio.
2	 Snapshot	Click to take a snapshot.
3	 Start/Stop recording	Click to start/stop recording.
4	 Digital Zoom	Click to zoom on/off .
5	 Full Screen	Full Screen.
6	 Time Expand/Narrow	Time narrow/expand.

2.6 Settings

2.6.1 Media

Video

Stream parameters can be set in this module, adapting to different network environments and demands.

Primary Stream Settings

The screenshot displays the 'Mlesight Network Camera' web interface. The top navigation bar includes 'English' and 'admin'. The left sidebar contains a menu with 'Media' (Video, Image, Audio), 'Network', 'Storage', 'Event', and 'System'. The main content area is titled 'Primary Stream' and has three tabs: 'Primary Stream', 'Secondary Stream', and 'Tertiary Stream'. The 'Primary Stream' tab is active, showing settings for 'Record Stream Type' with 'General' and 'Event' sub-tabs. The 'General' sub-tab is selected, displaying the following settings:

Parameter	Value	Unit
Record Stream Type	General	
Enable	<input type="checkbox"/>	
Video Codec	H.264	
Frame Size	1920*1080	
Maximum Frame Rate	25	fps
Bit Rate	4096	kbps
Smart Stream	Off	
Bit Rate Control	CBR	
Profile	Main	
I-frame Interval	50	frame(1-120)

A 'Save' button is located at the bottom of the settings panel.

Secondary Stream Settings

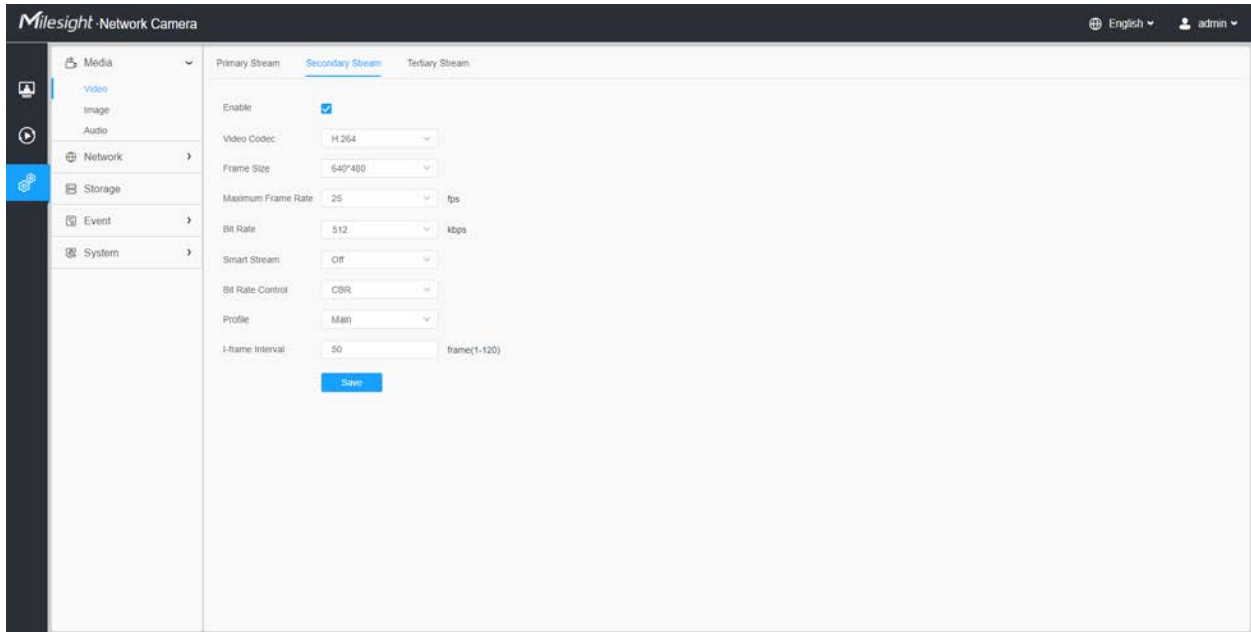

Tertiary Stream Settings

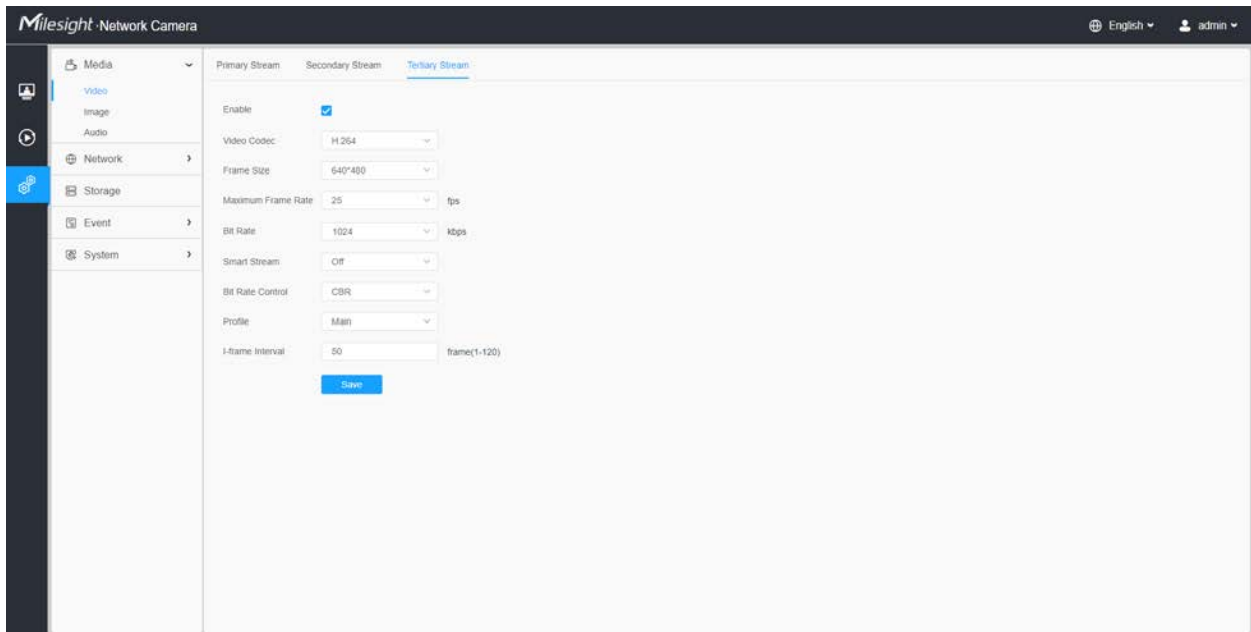



Table 9. Description of the buttons

Parameters	Function Introduction
Record Stream Type	<p>General & Event are available only for Primary Stream. General refers to continuous record video, while Event includes events that can trigger alarms, such as Motion, Exception, LPR and so on.</p> <p>This item can separately set different bit rate and frame rate for different Recording Stream Types. If user chooses Event, video will be recorded according to the configuration of video stream type when an event happens, thereby greatly reducing the recording storage space.</p>
Enable Event Stream	This item is optional only if you selected the Event.
Video Codec	H.265/H.264/MJPEG are available.
Frame Size	<p>Options include 8M(3840×2160), 6M(3072×2048), 5M(2592*1944), 5M(2560*1920), 5M(2560*1440), 4M(2592*1520), 3M(2304*1296), 3M(2048*1536), 1080P(1920*1080), 2M(1600 *1200), 1.3M(1280*960), 720P(1280*720), D1(704*576).</p> <p>For Secondary Stream, it includes 704*576, 640*480, 640*360, 352*288, 320*240, 320*192, 320*176.</p> <p>For Tertiary Stream, it include 1920*1080, 1280*720, 704*576, 640*480, 640*360, 352*288, 320*240, 320*192, 320*176.</p> <p> Note: The options of Frame Size are variable according to the model.</p>
Maximum Frame Rate	Maximum refresh frame rate of per second and it is variable according to the mode.
Bit Rate	<p>Transmitting bits of data per second, this item is optional only if you select the H.265/H.264</p> <p>Set the bitrate to 16~16384 Kbps. The higher value corresponds to the higher video quality, and the higher bandwidth is required as well.</p>
Smart Stream	<p>Optional to turn On/Off Smart Stream mode. Smart Stream mode remarkably reduces the bandwidth and the data storage requirements for network cameras while ensuring the high quality of images, and it is a 10-level adjustable codec.</p> <p>Level: Level 1~10 are available as needed.</p>
Bit Rate Control	CBR: Constant Bitrate. The rate of CBR output is constant.
Bit Rate Control	VBR: Variable Bitrate. VBR files vary the amount of output data per time segment.
Image Quality	Low/Medium/High are available, this item is optional only if you select VBR.

Parameters	Function Introduction
Profile	The option is for H.264, Main/High/Base can be selected as needed.
I-frame Interval	Set the I-frame interval to 1~120, 50 for the default. This item is optional only if you select the H.265/H.264. The number must be a multiple of the number of frames.

Image

General settings of image including the image adjustment, day/night setting and image enhancement can be set in this module. OSD (On Screen Display) content, privacy mask and video time can be displayed to rich the image information.

General

General settings of image including the Image Adjustment, White LED Light, Day/Night Switch, Day/Night Parameters, Exposure, Backlight, White Balance, Image Enhancement and Display can be set in this module.

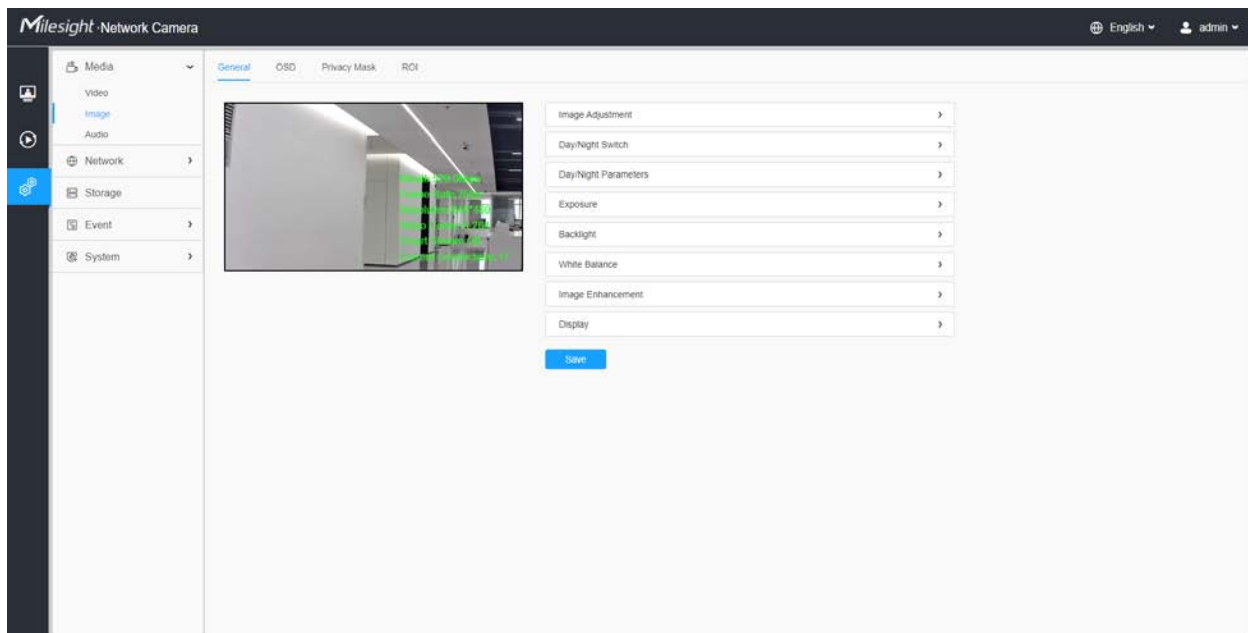

[Image Adjustment]

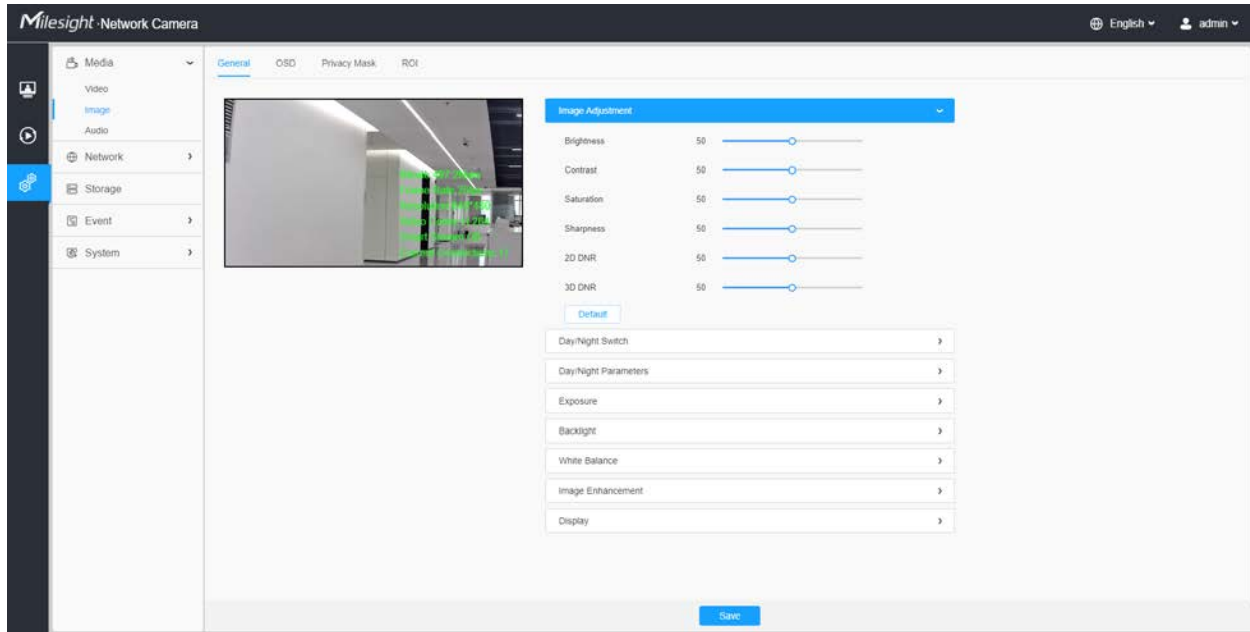
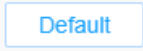

Table 10. Description of the buttons

Parameters	Function Introduction
Brightness	Adjust the Brightness of the scene.
Contrast	Adjust the color and light contrast.
Saturation	Adjust the Saturation of the image. Higher Saturation makes colors appear more "pure" while lower one appears more "wash-out".
Sharpness	Adjust the Sharpness of image. Higher Sharpness sharpens the pixel boundary and makes the image looks "more clear".
2D DNR	Adjust the noise reduction level.
3D DNR	Restore brightness, contrast and saturation to default settings.
	Click this button to restore to the default setting.

[White LED Light]

This option is used to control the White LED Light of the Supplement Light model. There are 4 options including Auto, Always On, Off and Customize are available.

Note:

- Make sure the camera model is a Supplement Light model with the White LED Light.
- White LED Light and IR Light can not be turned on at the same time.

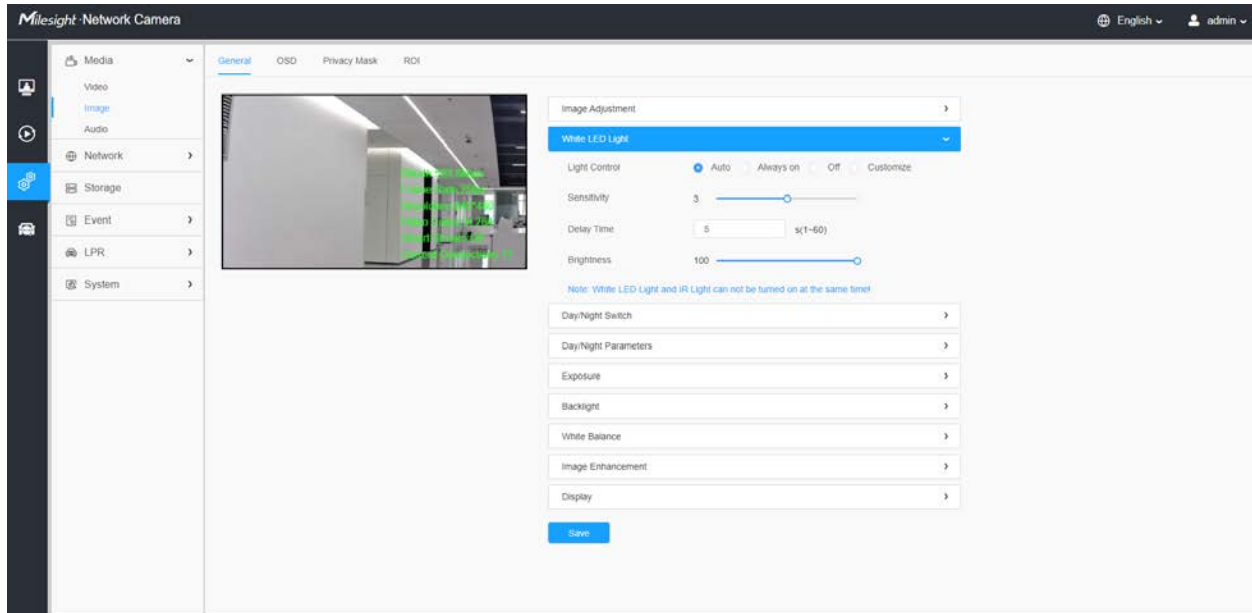
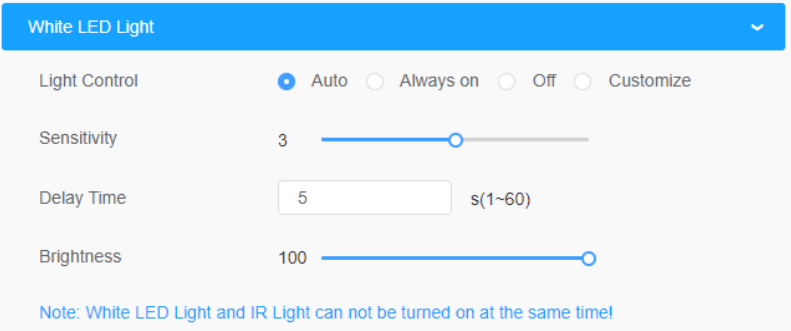



Table 11. Description of the options

Parameters	Function Introduction
<p>Light Control</p> <p>Auto</p>	<p>Select this option to automatically control the White LED Light based on the image. You can customize the sensitivity and delay time.</p>  <ul style="list-style-type: none"> • Sensitivity: This option is to adjust the sensitivity of the White LED Light, level 1~5 are available, and the default level is 3. The higher the sensitivity, the easier it is to switch the White LED Light status according to image light changes. For example, when the sensitivity is set to level 5, it will turn on the White LED Light when the light in the environment is not very dark. • Delay Time: This option is to avoid the White LED Light status changes due to sudden light changes in the environment. The longer the delay time, the longer the response time for the White LED Light to turn on and off. 1~60s are available, and the default option is 5s. For example, here I set the delay time to 5 seconds, if the image suddenly brightens due to a passing car with its headlights on, the white LED light will not be turned off immediately.
<p>Always On</p>	<p>Select this option to keep the White LED Light always on.</p>
<p>Off</p>	<p>Select this option to keep the White LED Light always off.</p>

Parameters		Function Introduction
	Customize	<p>Select this option to customize the Start Time and End Time of the White LED Light.</p> 
Brightness		Users can customize the brightness, levels 1-100 are available, the higher the level, the brighter the White LED Light.



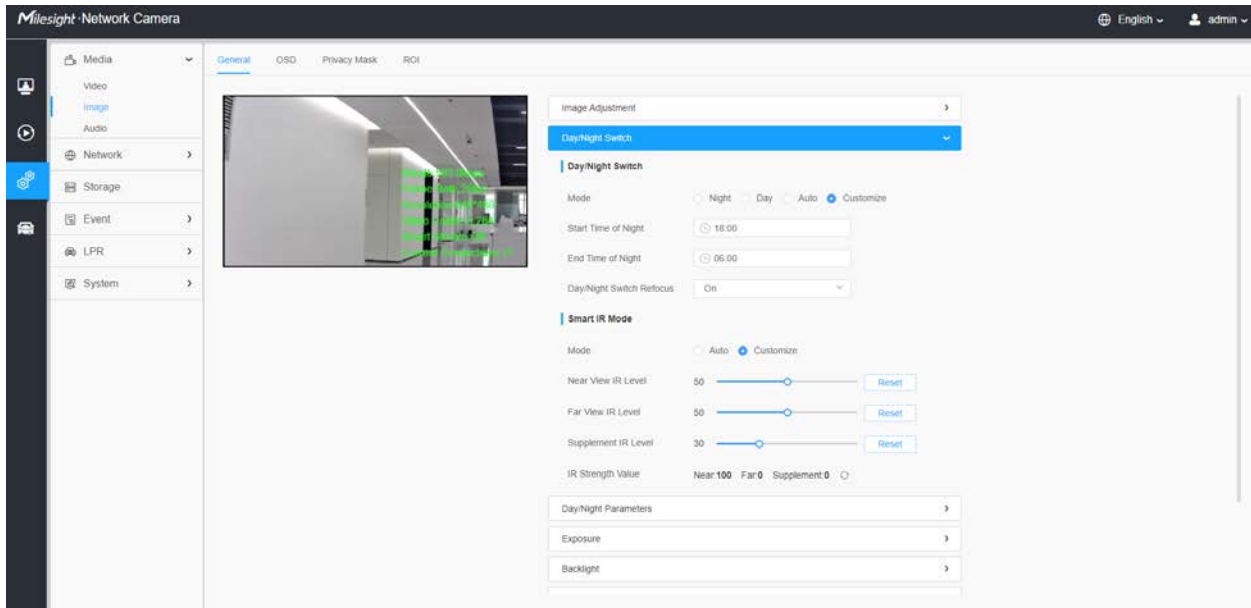

[Day/Night Switch]

This option is used to control the Day/Night mode. And we applied **Smart IR II Technology** on the camera. It combines the High Beam and Low Beam, upgrading the IR LEDs technology to provide better image clarity and quality regardless of the object distance. Also, the Low Beam and High Beam's brightness can be adjusted manually or automatically on the basis of the Zoom ratio. Moreover, with the IR anti-reflection panel, the infrared light transmittance is highly increased.



There are 4 modes for Day/Night Switch, including Night, Day, Auto and Customize.

Table 12. Description of the options

Parameters		Function Introduction
Day/Night Switch	Night	Switch to Night Mode according to the parameters of night mode.  Note: There are several parameters such as Exposure Level, Maximum Exposure Time and IR-CUT Interval, etc, associated with the mode.
	Day	Switch to Day Mode according to the parameters of day mode.  Note: There are several parameters such as Exposure Level, Maximum Exposure Time and IR-CUT Interval, etc, associated with the mode.
	Auto	Select this option to automatically switch the Day/Night Mode based on the image. <ul style="list-style-type: none"> • Day to Night Value: You can set the sensitivity for switching Day Mode to Night Mode. When IR Light Sensor Current Value is lower than this value, it will switch Day Mode to Night Mode. You can click  to reset the value to 36. • Night to Day Value: This is the sensitivity for switching Night Mode to Day Mode. When IR Light Sensor Current Value is higher than this value, it will switch Night Mode to Day Mode. You can click  to reset the value to 82. • IR Light Sensor Value: The current value of the IR light sensor.
	Customize	Select this option to customize the Start Time and End Time of Night. <ul style="list-style-type: none"> • Start Time of Night: You can set the time to start the Night Mode. • End Time of Night: You can set the time to start the Day Mode.
	Day/Night Switch Refocus	With this option enabled, the camera will refocus when switching between day mode and night mode.

There are 2 modes for Smart IR Mode to achieve the best effect, including Auto and Customize.

Table 13. Description of the buttons

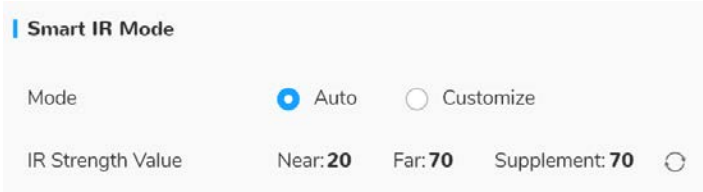
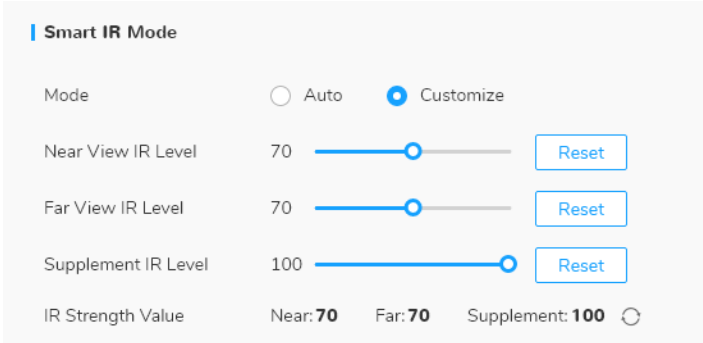
Parameters		Function Introduction
Smart IR Mode	Auto	<p>Select this option to automatically adjust the strength of the Low-Beams LED, High-Beams LED and IR LED Supplement Light on the basis of the Zoom ratio.</p>  <p>Note:</p> <ul style="list-style-type: none"> • In Auto Mode, the strength of the IR Supplement Light will be the same as that of the High-Beams LED. • For the IR LRD Supplement Light function, make sure the camera model is a Supplement Light model with the IR LED Light.
	Customize	<p>Select this option to manually adjust the strength of the Low-Beams LED, High-Beams LED and IR LED Supplement Light. You can see the effect of these LEDs in the image in real-time as you adjust the strength, and you can also click Reset to reset the light strength.</p> <ul style="list-style-type: none"> • Near View IR Level: Adjust the light strength of Low-Beams LED light level from 0 to 100. • Far View IR Level: Adjust the light strength of High-Beams LED light level from 0 to 100. • Supplement IR Level: Adjust the strength of IR Supplement Light from 0 to 100. • IR Strength Value: Show the current value of Low-Beams LED, High-Beams LED and IR LED Supplement Light value.  <p>Note: For the video demo of the supplement light, you can refer to:</p> <ul style="list-style-type: none"> • IR LED Supplement Light: https://youtu.be/YVTVR88V0Rg • White LED Supplement Light: https://youtu.be/wn18oEzY5yk

[Day/Night Parameters]

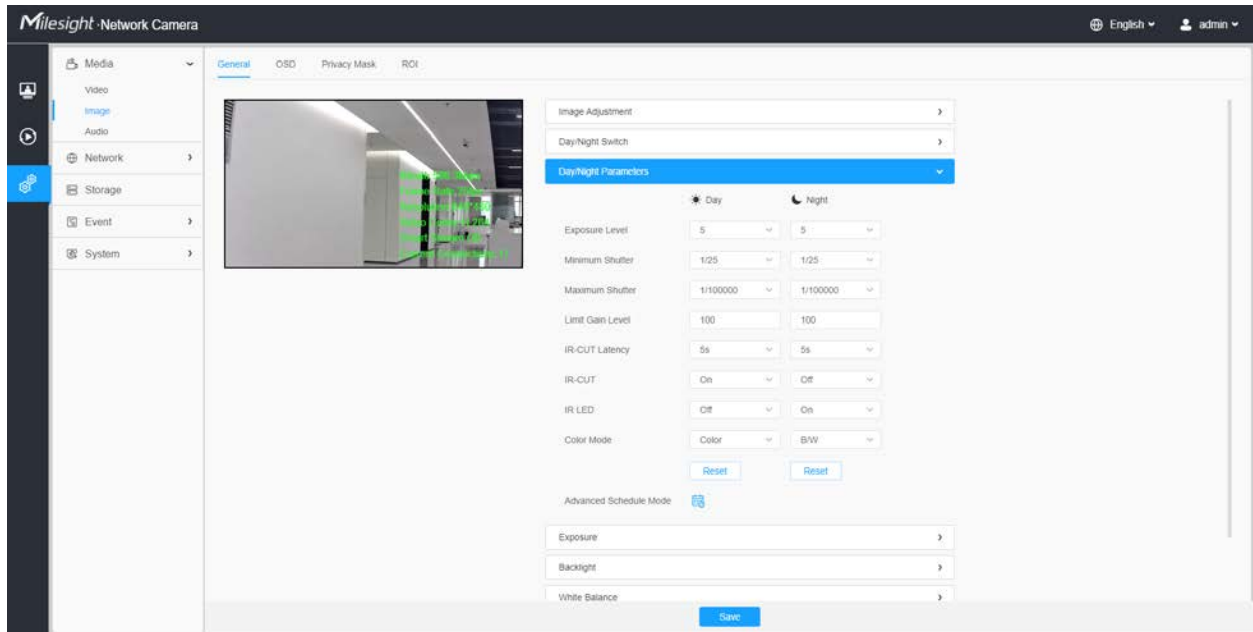

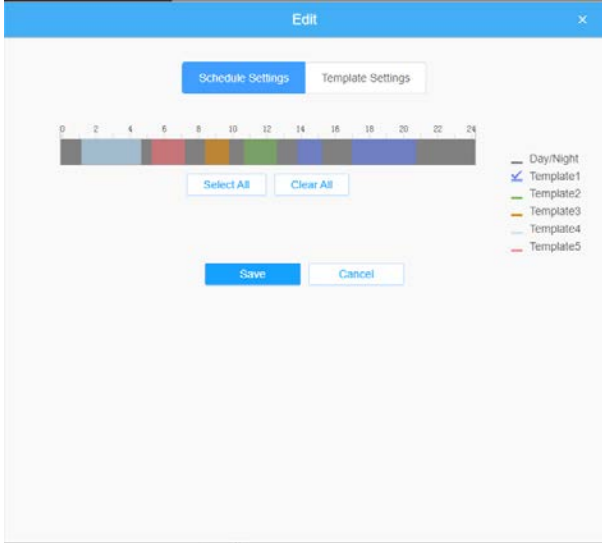

Table 14. Description of the buttons

Parameters	Function Introduction
Exposure Level	Level 0~10 are available to meet your need.
Minimum Shutter	Minimum Shutter is the same as Maximum Exposure Time. Set the minimum Shutter to 1~1/100000s.
Maximum Shutter	Maximum Shutter is the same as Minimum Exposure Time. Set the maximum Shutter to 1~1/100000s.
IR-CUT Latency	The interval time of switching one mode to another.
Limit Gain Level	Set the Limit Gain Level to 1~100.
IR-CUT	Turn on/off IR-CUT.
IR LED	Turn on/off IR-LED.
Color Mode	Select B/W or Color mode.

Parameters	Function Introduction
<div style="text-align: center;">  <p>Advanced Schedule Mode</p> </div>	<p>Here you can customize your special demands for different time, then the Day mode and Night mode will switch automatically according to your settings.</p> 

[Exposure]

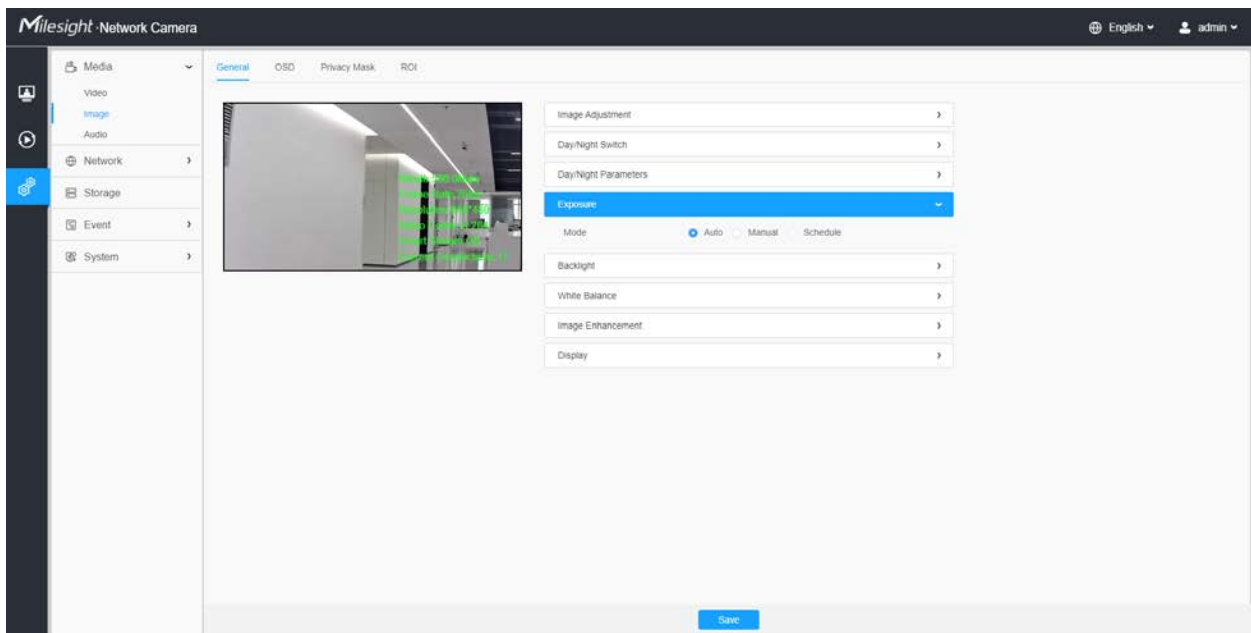
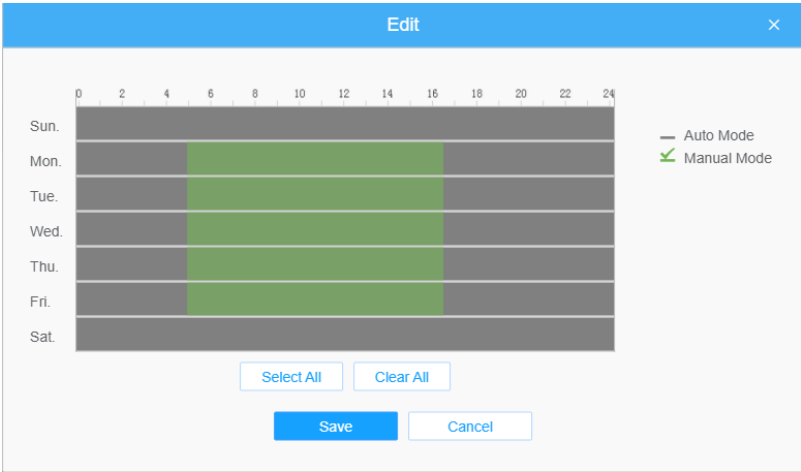

Table 15. Description of the buttons

Parameters	Function Introduction
<p style="text-align: center;">Exposure Mode</p>	<p>Auto Mode, Manual Mode and Schedule Mode are available.</p> <p>Auto Mode: The camera will adjust the brightness according to the light environment automatically.</p> <p>Manual Mode: The camera will adjust the brightness according to the value you set, you can set the exposure time from 1~1/100000s, the higher the value is, the brighter the image is.</p> <p>Schedule Mode: You can customize the schedule to enable/disable Auto Mode and Manual Mode.</p> 

[Backlight]

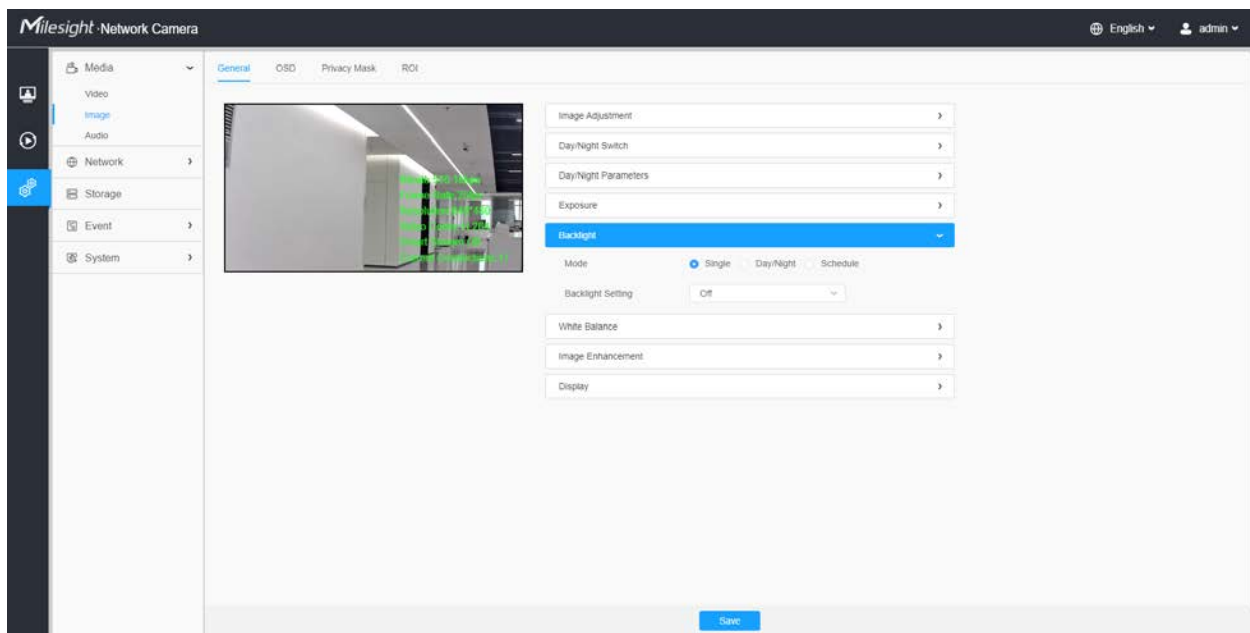

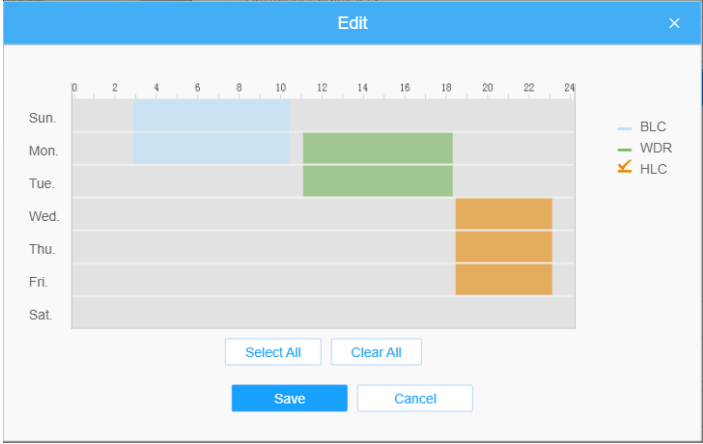

Table 16. Description of the buttons

Parameters	Function Introduction
<p style="text-align: center;">Backlight Mode</p>	<p>Single Mode: Set single mode for BLC/WDR/HLC.</p> <p> Note: Do not support WDR and General HLC while High Frame Rate is enabled.</p> <p>Day/Night Mode: Support BLC/WDR/HLC on Day Enhancement Mode/Night Enhancement Mode separately.</p> <p>Schedule Mode: Set schedule mode for BLC/WDR/HLC. You can customize the schedule to enable/disable BLC/WDR/HLC mode.</p> 

 **Note:**

- For more details about **Milesight WDR on & off Video**, you can click to the YouTube:
<https://www.youtube.com/watch?v=McoOL0Pyk0w>
- For more details about **Milesight Ultra Low-light Video Demo - HLC**, you can click to the YouTube:
<https://www.youtube.com/watch?v=ly8uKWbii40>
- For more details about **Milesight Super WDR Pro**, you can click to the YouTube:
<https://www.youtube.com/watch?v=edsPZXBjRnl>
- For more details about **Milesight Super WDR Performance**, you can click to the YouTube:
<https://www.youtube.com/watch?v=BKEZ6BW-YZE>

[White Balance]

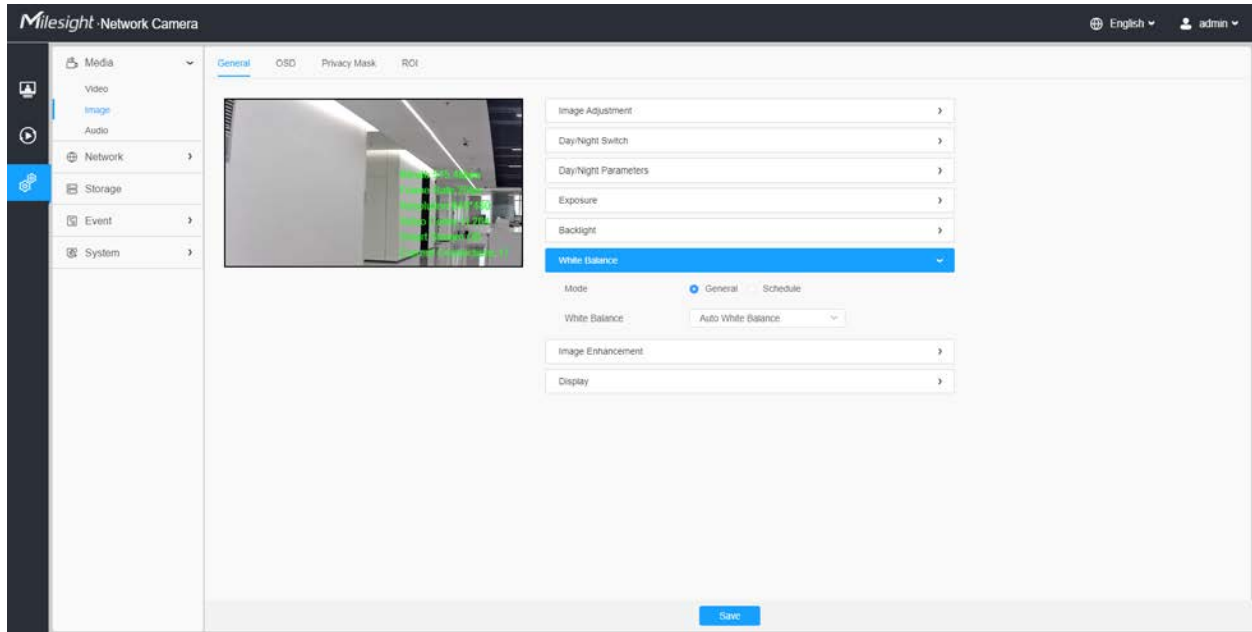
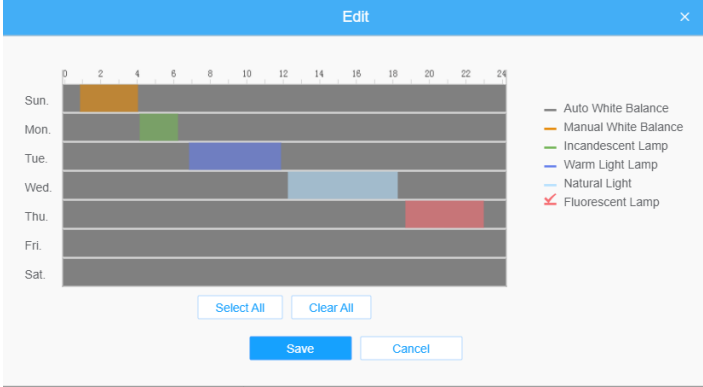

Table 17. Description of the buttons

Parameters	Function Introduction
<p>White Balance</p>	<p>To restore white objects, removed color distortion caused by the light of the environment.</p> <p>Mode: General and Schedule are available.</p> <hr/> <p>General Mode: Select a white balance mode as required</p> <ul style="list-style-type: none"> • Auto White Balance: This option will automatically enable the White Balance function. • Manual White Balance: Set Red Gain Level and Blue Gain Level manually. • Incandescent Lamp: Select this option when light is similar with incandescent lamp. • Warm Light Lamp: Select this option when light is similar with warm light lamp. • Natural Light: Select this option when there is no other light but natural light. • Fluorescent Lamp: Select this option when light is similar with Fluorescent Lamp.

Parameters	Function Introduction
	<p>Schedule Mode: Select this option that you can customize the schedule to enable/ disable above modes.</p> 

[Image Enhancement]

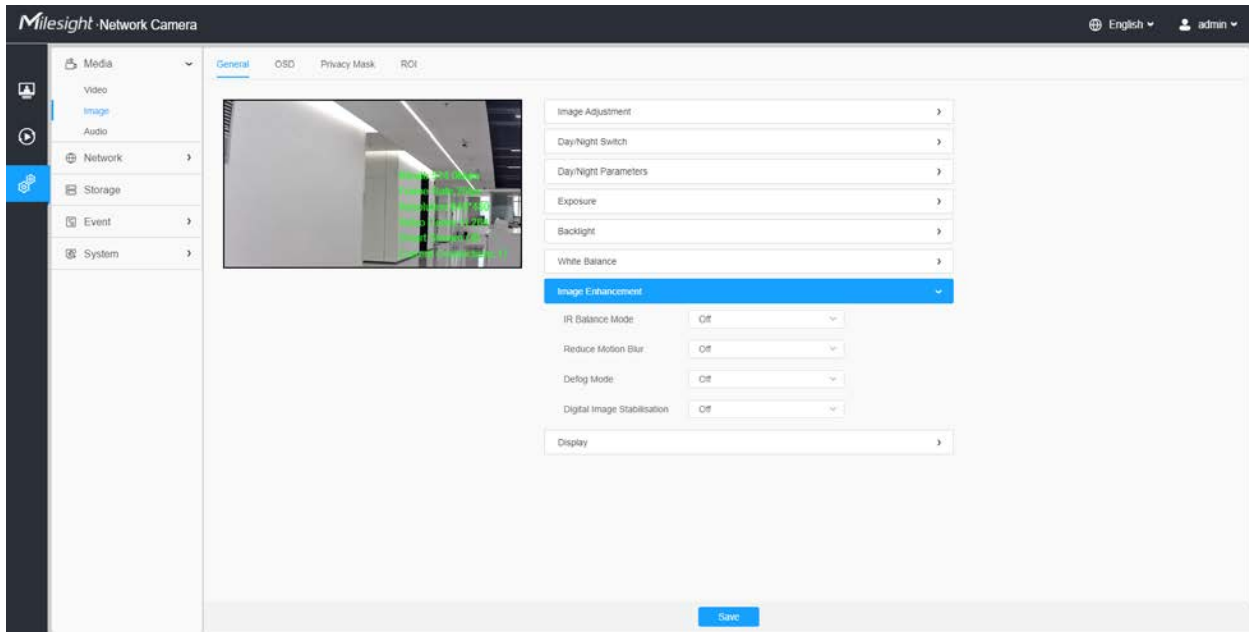



Table 18. Description of the buttons

Parameters	Function Introduction
<p>IR Balance Mode</p>	<p>There is an option to turn On/Off the IR LED.</p> <p>IR Balance Mode would avoid the problem of overexposure and darkness, and the IR LED will change according to the actual illumination.</p>

Parameters	Function Introduction
Reduce Motion Blur	<p>Enable this function to reduce the motion blur of objects effectively.</p> <p>You can adjust the deblur level from 1 to 100.</p> <p> Note: For more details about Milesight Deblur, you can click to the YouTube: https://www.youtube.com/watch?v=-vynrami51s</p>
Defog Mode	<p>Better image effect in foggy weather.</p> <p> Note:</p> <ul style="list-style-type: none"> For more details about Milesight Defog, you can click to the YouTube: https://www.youtube.com/watch?v=a9od7Trao4U
Digital Image Stabilisation	Decrease the blur and shakiness of the image.

[Display]

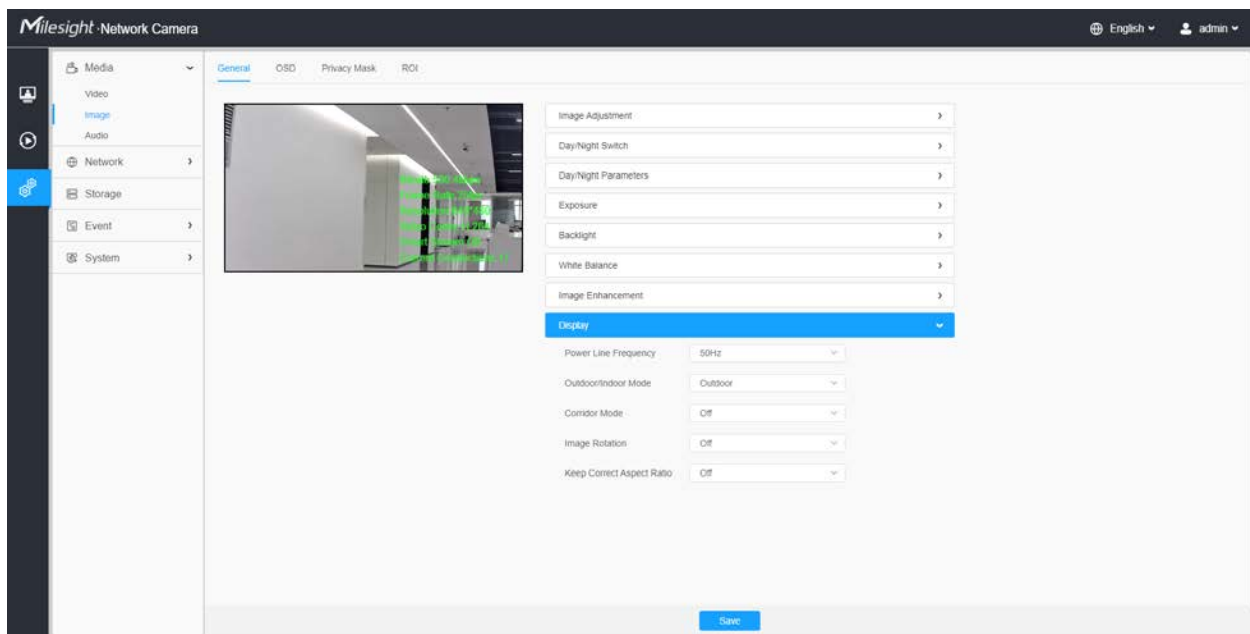





Table 19. Description of the buttons

Parameters	Function Introduction
Power Line Frequency	60Hz and 50Hz are available.
Outdoor/Indoor Mode	Select indoor or outdoor mode to meet your needs.

Parameters	Function Introduction
Corridor Mode	<p>There are three options available, you can select one to meet your need.</p> <p>Off: Keep the image in normal direction.</p> <p>Clockwise 90°: Rotate the image by 90° clockwise.</p> <p>Anticlockwise90°: Rotate the image by 90° anticlockwise.</p>
Image Rotation	<p>There are four options available, you can select one to meet your need.</p> <p>Off: Keep the image in normal direction.</p> <p>Rotating 180°: Upside down the image.</p> <p>Flip Horizontal: Flip the image horizontally.</p> <p>Flip vertical: Flip the image vertically.</p>
Keep Correct Aspect Ratio	<p>With this option enabled, the camera will prevent the image from distortion when resolution ratio is changed.</p>
Zoom Limit	<p>Set the Zoom Limit.</p> <p> Note: Only for the PTZ Network Camera with optical zoom of 20X or above.</p>
White LED Level	<p>Set the White LED Level to 1~100.</p> <p> Note: Only for PTZ Bullet.</p>
Smoked Dome Cover	<p>This function is only for Pro Dome. If Pro Dome is equipped with a Smoked Dome Cover, enable this function to display a normal image.</p> <p> Note: Only for Pro Dome.</p>

OSD

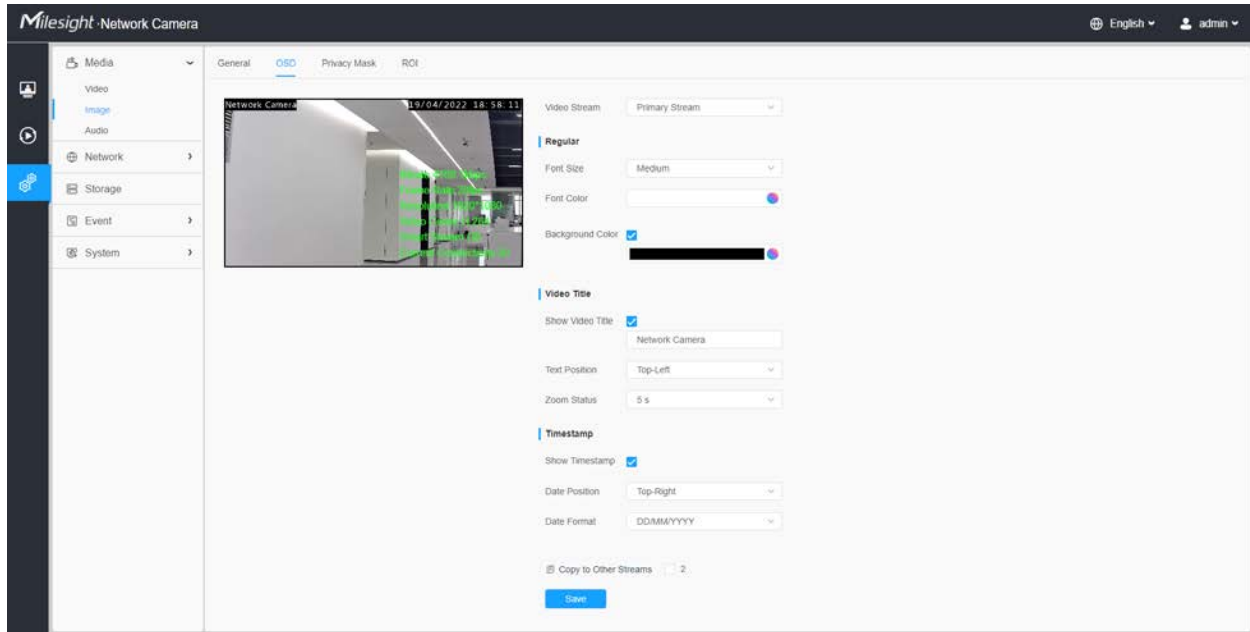



Table 20. Description of the buttons

Parameters	Function Introduction
Video Stream	Enable to set OSD for primary stream and secondary stream.
Font Size	Smallest/Small/Medium/Large/Largest/Auto are available for title and date.
Font Color	Enable to set different color for title and date.
Background Color	<p>Enable to set different colors for display information background on screen.</p> <p>You can set different colors for font and background of image , then the image OSD will show as below:</p> 
Show Video Title	Check the check box to show video title.
Video Title	Customize the OSD content.
Text Position	OSD display position on the image.
Show Timestamp	Check the checkbox to display date on the image.

Parameters	Function Introduction
Date Position	Date display position on the image.
Date Format	The format of date.
Copy to Other Streams	Copy the settings to other streams.

Privacy Mask

Privacy mask enables to cover certain areas on the live video to prevent certain spots in the surveillance area from being viewed and recorded.

You can select the color type and mosaic type to use for the cover certain areas on the live video. The mosaic type can maintain the continuity of the picture and improve the visual effect. Up to 28 mask areas are supported, which includes 24 mask areas and 4 mosaic areas.

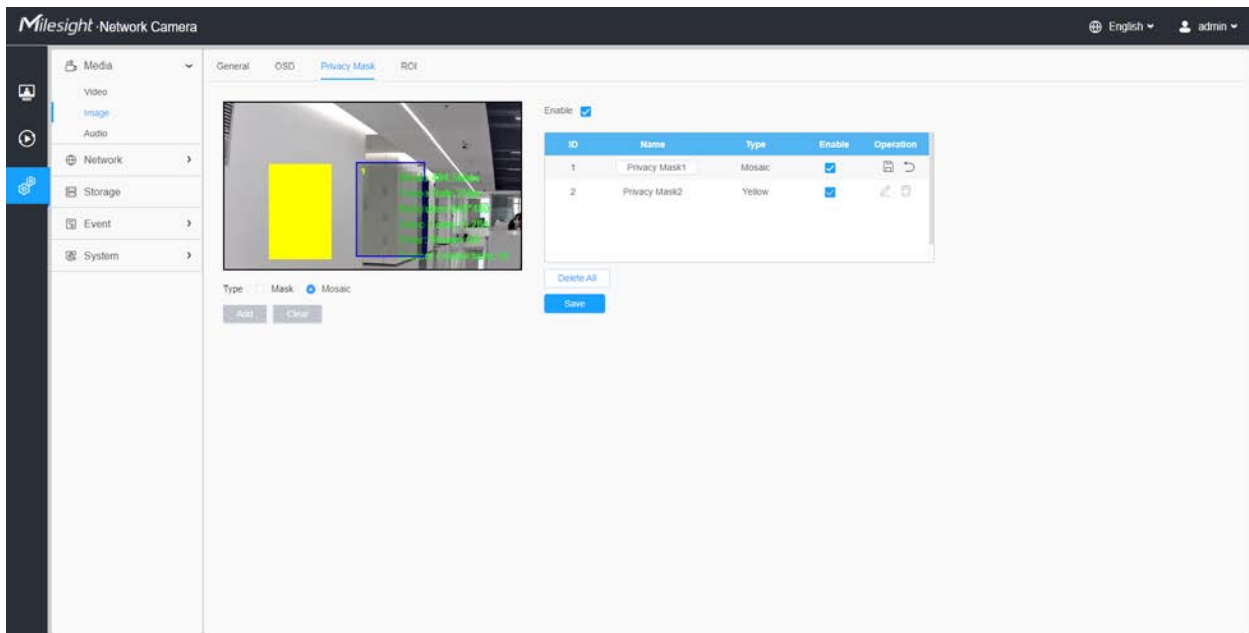
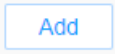
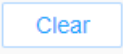





Table 21. Description of the buttons

Parameters	Function Introduction
Enable	Check the check box to enable the Privacy Mask function.
Type	Select the type to use for the privacy areas, there are two types available: Mask and Mosaic.
	Drew an privacy area on the live video as needed.

Parameters	Function Introduction	
	Clear the area you drew on the live video.	
Operation		Enable/disable the selected ROI areas.
		Change the color of Mask area, there are eight colors available: White, Black, Blue, Yellow, Green, Brown, Red and Purple
		Delete the privacy mask area

ROI

Region of interest (often abbreviate ROI), is a selected subset of samples within a dataset identified for a particular purpose. Users can select up to 8 key regions of a scene to transmit through separate streams for targeted preview and recording.

By using Milesight ROI technology, more than 50% of bit rate can be saved and therefore less bandwidth demanded and the storage usage reduced. So according to this, you can set a small bit rate for high resolution.

 **Note:** For more details about how to set ROI, please refer to <https://milesight.freshdesk.com/a/solutions/articles/69000643441>.

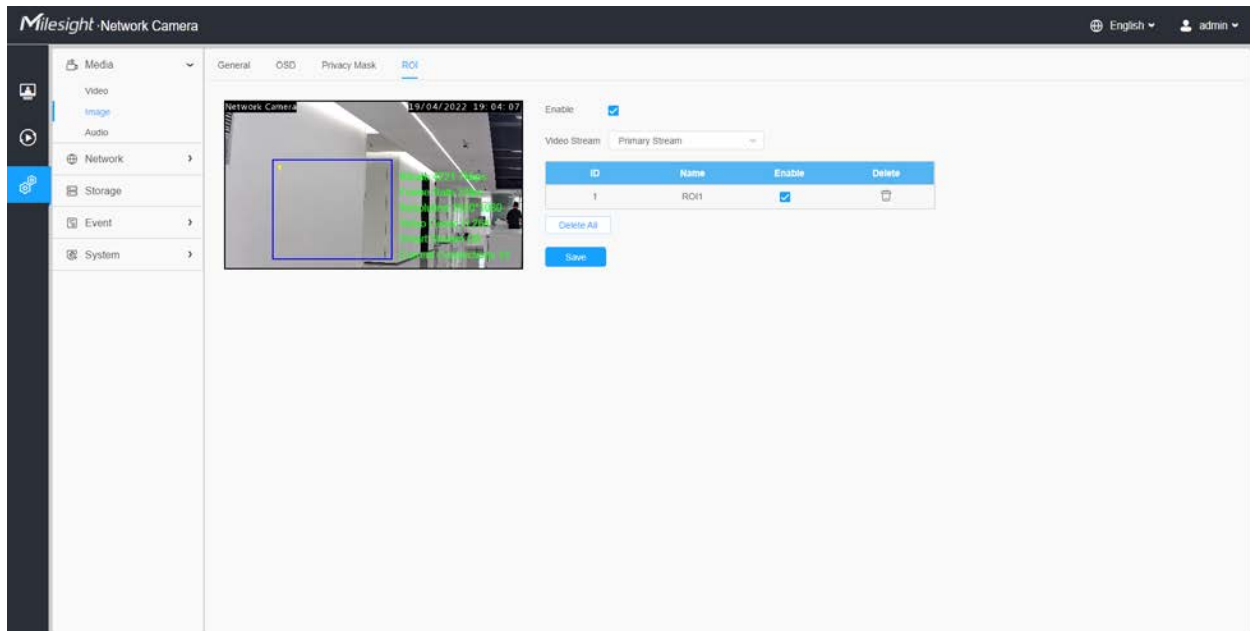



Table 22. Description of the buttons

Parameters	Function Introduction	
Enable	Check the checkbox to enable the ROI function.	
Video Stream	Choose the Video Stream.	
ROI		Enable/disable the selected ROI areas.
		Delete the selected ROI areas.
Delete All	Clear all areas you drew before.	

 **Note:**

- You can set a low bit rate. For example, you can set a bit rate with 512Kbps and a resolution with 1080P, then you can see the image quality of ROI is more clear and fluent than the other region.

Audio

Audio

This audio function allows you to hear the sound from the camera or transmit your sound to the camera side. A two-way communication is also possible to be achieved with this feature. Alarm can be triggered when the audio input is above a certain alarm level you set, and configured audio can be played when an alarm occurs.

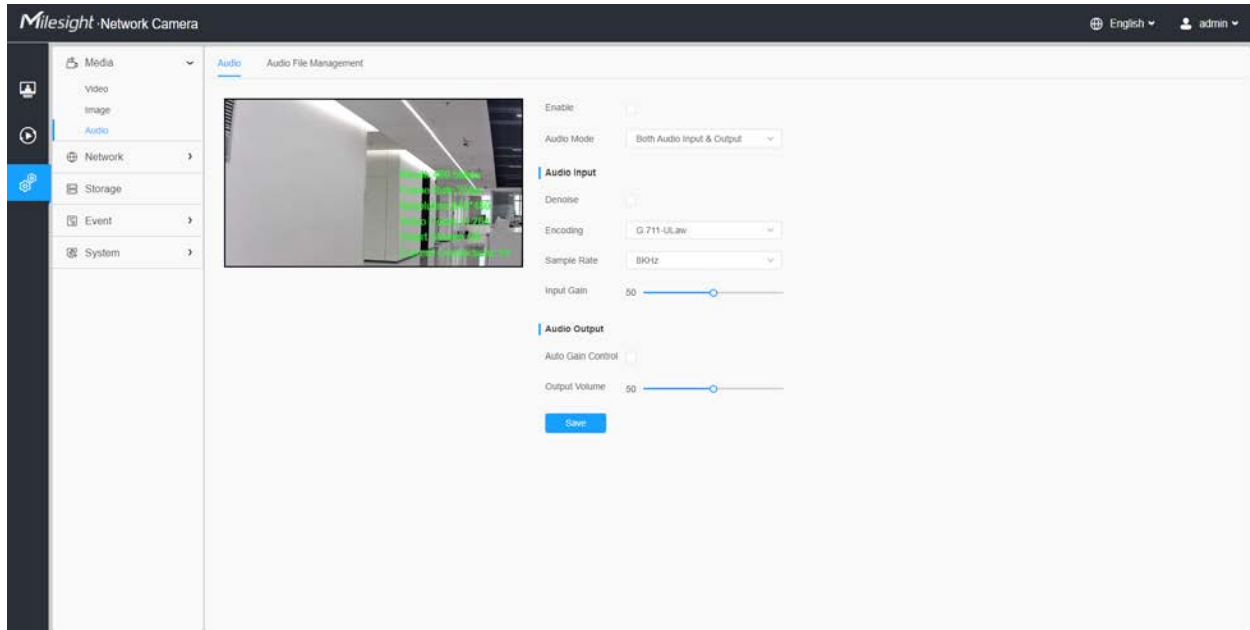
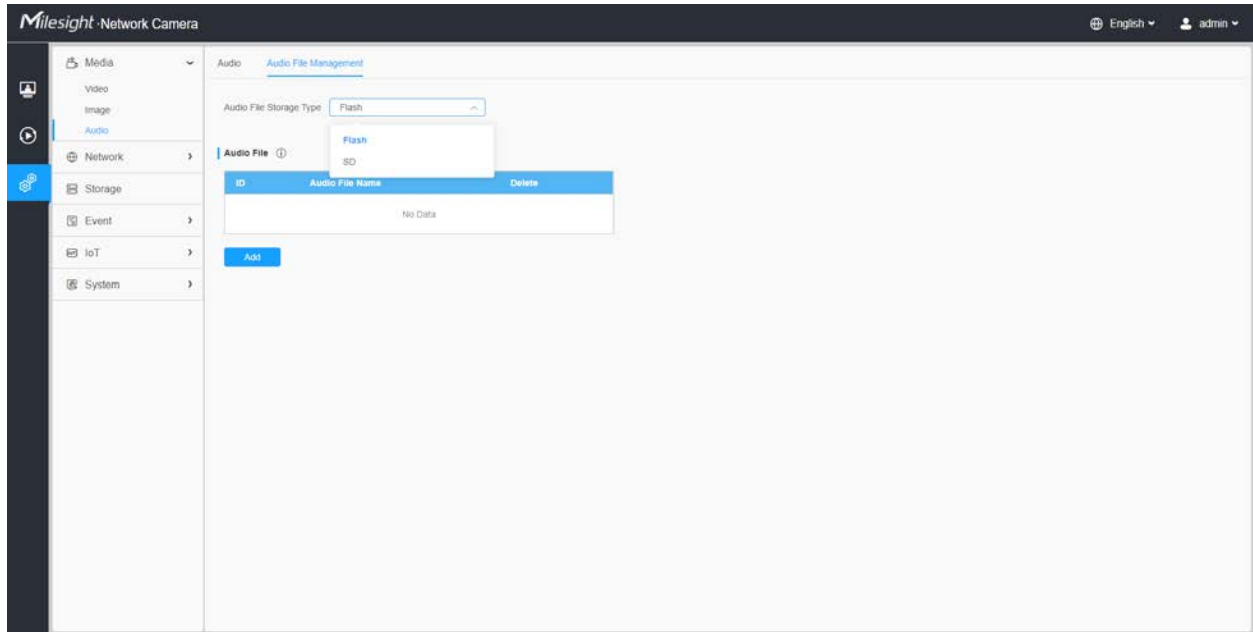

Table 23. Description of the buttons

Parameters	Function Introduction
Enable	Check on the checkbox to enable audio feature.
Audio Mode	Audio Input/Audio Output/Both Audio Input & Output are optional.
Audio Input	<p>Denoise: Set it as On/Off. When you set the function on, the noise detected can be filtered.</p> <p>Encoding: G.711-ULaw, G.711-ALaw, AAC LC, G.722 and G.726 are available</p> <p>Audio Bit Rate: The function is available only for AAC LC, and supports up to 48kbps.</p> <p>Sample Rate: 8KHz, 16KHz, 32KHz, 44.1KHz, and 48KHz are available.</p> <p>Input Gain: Input audio gain level, 0-100.</p> <p>Alarm Level: Alarm will be triggered if voice alarm is enabled and input gained volume is higher than the alarm level, 1-100.</p>
Audio Output	<p>Auto Gain Control: This function is only for H.265 series, improve the quality of audio</p> <p>Output Volume: Adjust volume of output</p>

Auto File Management

You can upload up to 5 audio files manually to Flash or SD Card on the Audio web page and you can also edit the audio file's name when upload.



Note:

- The Audio mode and Audio Output are only for certain modules.
- Only support '.wav' audio files with codec type PCM/PCMU/PCMA, 64kbps or 128 kbps and no more than 500k.

2.6.2 Network

2.6.2.1 Basic

TCP/IP

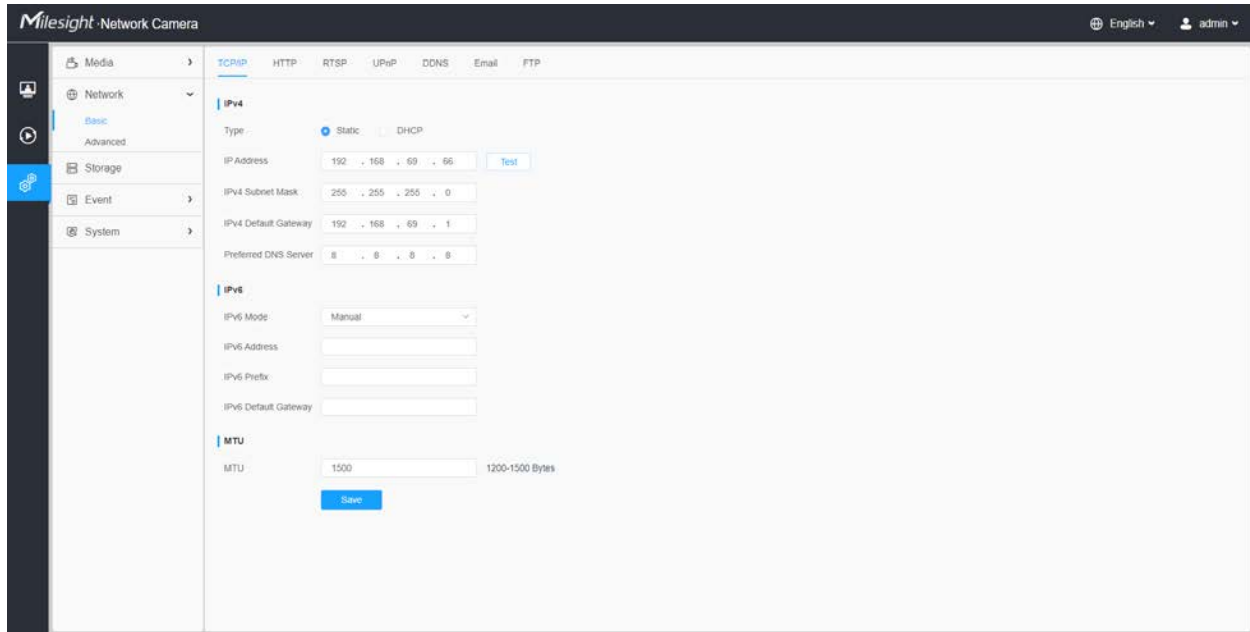



Table 24. Description of the buttons

Parameters	Function Introduction
IPv4	<p>Type: Static Type and DHCP Type are optional for user to get IPv4 address automatically or use fixed IP address.</p> <p>IPv4 Address: An address that used to identify a network camera on the network.</p> <p> Note: The Test button is used to test if the IP is conflicting.</p> <p>IPv4 Subnet Mask: It is used to identify the subnet where the network camera is located.</p> <p>IPv4 Default Gateway: The default router address.</p> <p>Preferred DNS Server: The DNS Server translates the domain name to IP address.</p>
IPv6	<p>IPv6 Mode: Choose different modes for IPv6: Manual/Route Advertisement/DHCPv6</p> <p>IPv6 Address: IPv6 Address used to identify a network camera on the network</p> <p>IPv6 Prefix: Define the prefix length of IPv6 address</p> <p>IPv6 Default Gateway: The default router IPv6 address</p>
MTU	<p>Maximum Transmission Unit. The default value is 1500. You can customize the value from 1200 to 1500 as needed.</p>
<div style="background-color: #007bff; color: white; padding: 5px; display: inline-block;">Save</div>	<p>Save the configuration.</p>

HTTP

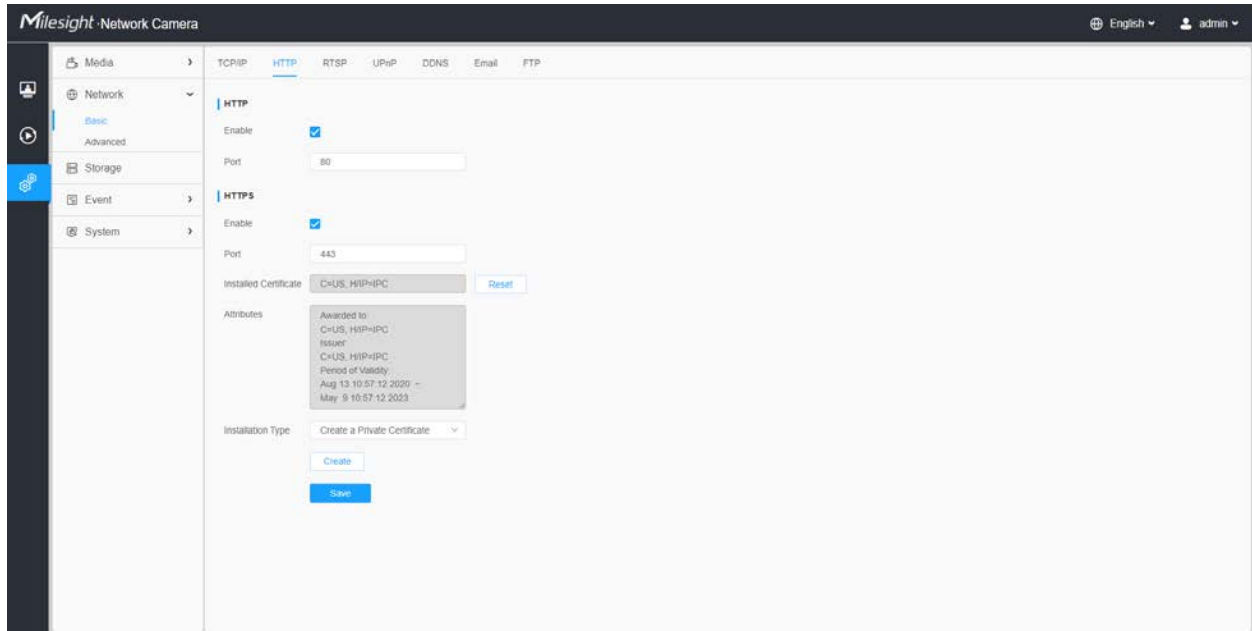

Table 25. Description of the buttons

Parameters	Function Introduction
HTTP	<p>Enable: Start or stop using HTTP.</p> <p>Port: Web GUI login port, the default is 80, the same with ONVIF port.</p>
HTTPS	<p>Enable: Start or stop using HTTPSs.</p> <p>Port: Web GUI login port via HTTPS, the default is 443.</p> <p>Note: For more details about how to use enable HTTPS access, please refer to https://milesight.freshdesk.com/a/solutions/articles/69000797384.</p>
Installed Certificate	Upload and set the SSL certificate.
Attributes	
Installation Type	
Save	Save the configuration.

Table 26. HTTP URL are as below:

Stream	URL
Main Stream	http://username:password@IP:port/ipcam/mjpeg.cgi
Secondary Stream	http://username:password@IP:port/ipcam/mjpegcif.cgi
Tertiary Stream	http://username:password@IP:port/ipcam/mjpegthird.cgi

RTSP

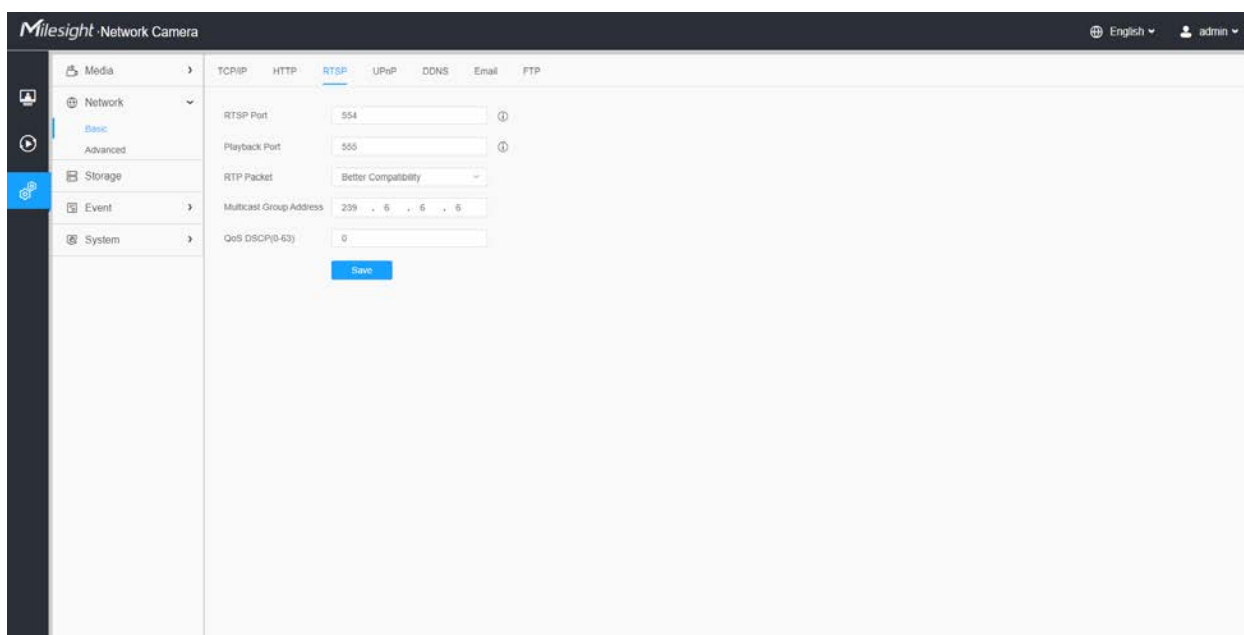



Table 27. Description of the buttons

Parameters	Function Introduction
RTSP Port	The port of RTSP, the default is 554.
Playback Port	Playback Port The port of playback, the default is 555.  Note: Port 0 means closing playback function.
RTP Packet	There are Better Compatibility and Better Performance two options, if your camera's image mess up, please switch this option.
Multicast Group Address	Support multicast function.

Parameters	Function Introduction
QoS DSCP	The valid value range of the DSCP is 0-63.
	Save the configuration.

Table 28. RTSP URL are as below:

Stream	URL
Primary Stream	rtsp://IP:RTSP Port/main
Secondary Stream	rtsp://IP:RTSP Port/sub
Tertiary Stream	rtsp://IP:RTSP Port/third

Note:

- DSCP refers to the Differentiated Service Code Point; and the DSCP value is used in the IP header to indicate the priority of the data.
- A reboot is required for the settings to take effect.

UPnP

Universal Plug and Play (UPnP) is a networking architecture that provides compatibility among networking equipment, software and other hardware devices. The UPnP protocol allows devices to connect seamlessly and to simplify the implementation of networks in the home and corporate environments. With the function enabled, you don't need to configure the port mapping for each port, and the camera is connected to the Wide Area Network via the router.

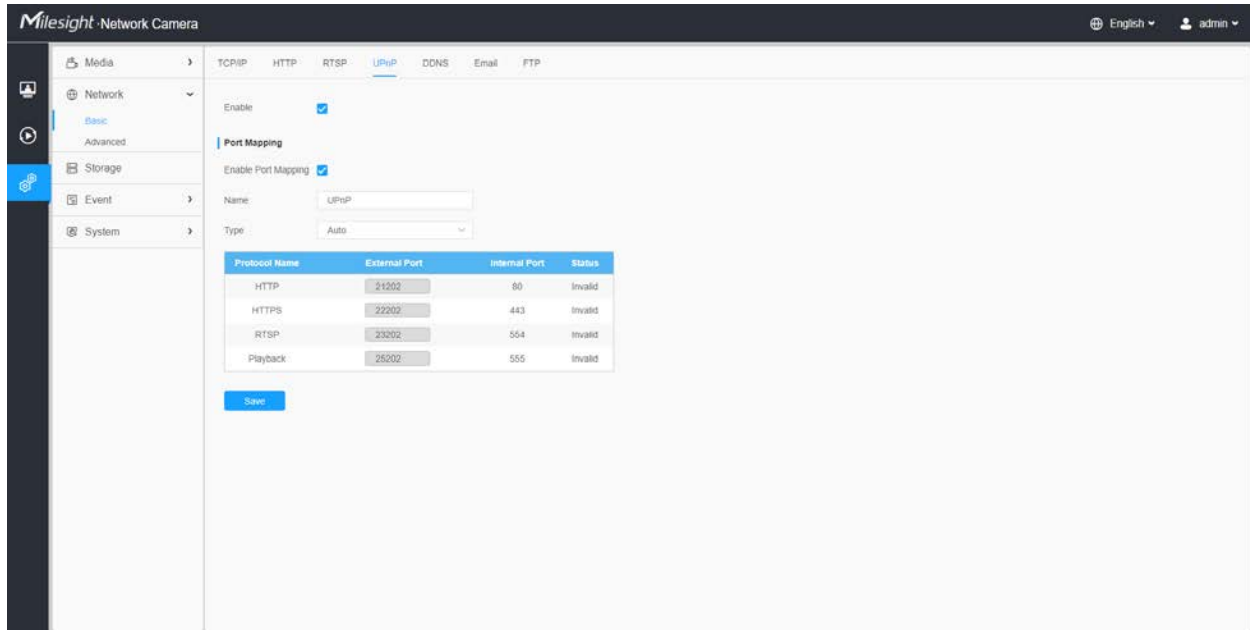

Table 29. Description of the buttons

Parameters	Function Introduction
Enable	Check the checkbox to enable the UPnP function.
Enable Port Mapping	Check the checkbox to enable the Port Mapping
Name	The name of the device detected online can be edited
Type	<p>Auto: Automatically obtain the corresponding HTTP and RTSP port, without any settings</p> <p>Manual: Need to manually set the appropriate HTTP port and RTSP Port. When choose Manual, you can customize the value of the port number by yourself</p>
Save	Save the configuration.

DDNS

DDNS allows you to access the camera via domain names instead of IP address. It manages to change IP address and update your domain information dynamically. You need to register an account from a provider.

Note: For more details about how to set DDNS, please refer to <https://milesight.freshdesk.com/a/solutions/articles/69000643406>.

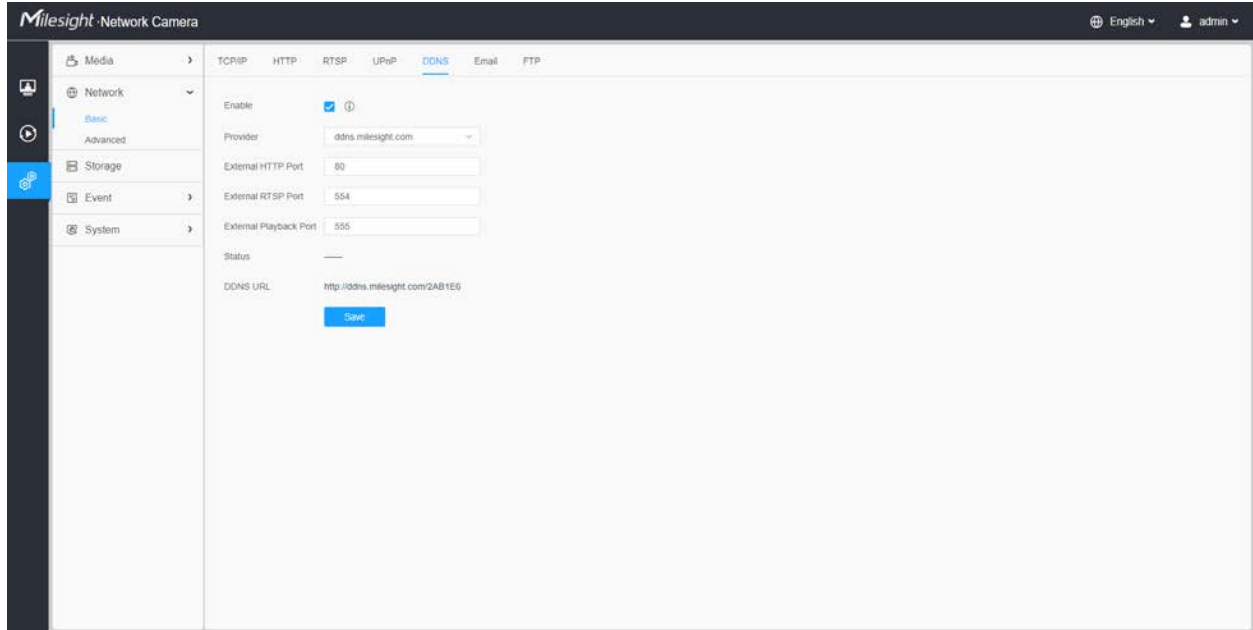

You can choose “ddns.milesight.com” as provider for DDNS. After enabling it, you can access the device via the URL “http://ddns.milesight.com/MAC address”.

Table 30. Description of the buttons

Parameters	Function Introduction
Enable DDNS	Check the checkbox to enable DDNS service.  Note: Recommend to enable and configure UPnP ports which can be used directly in DDNS.
Provider	Get support from DDNS provider: ddns.milesight.com, freedns.afraid.org, dyndns.org, www.no-ip.com, www.zoneedit.com. You can also customize the provider for DDNS.
Hash	A string used for verifying, only for "freedns.afraid.org".
User name	Account name from the DDNS provider, unavailable for "freedns.afraid.org".
Password	Account password, unavailable for "freedns.afraid.org".
Host name	DDNS name enabled in the account.
Status	Display DDNS running status.

Parameters	Function Introduction
<div style="text-align: center; border: 1px solid black; width: 80px; margin: 0 auto; background-color: #007bff; color: white; padding: 5px;">Save</div>	Save the configuration.

 **Note:**

- Please do the Port Forwarding of HTTP Port and RTSP Port before you use Milesight DDNS.
- Make sure that the internal and the external port number of RTSP are the same.

Email

Alarm video files can be sent to specific mail account through SMTP server. You must configure the email settings correctly before using it.

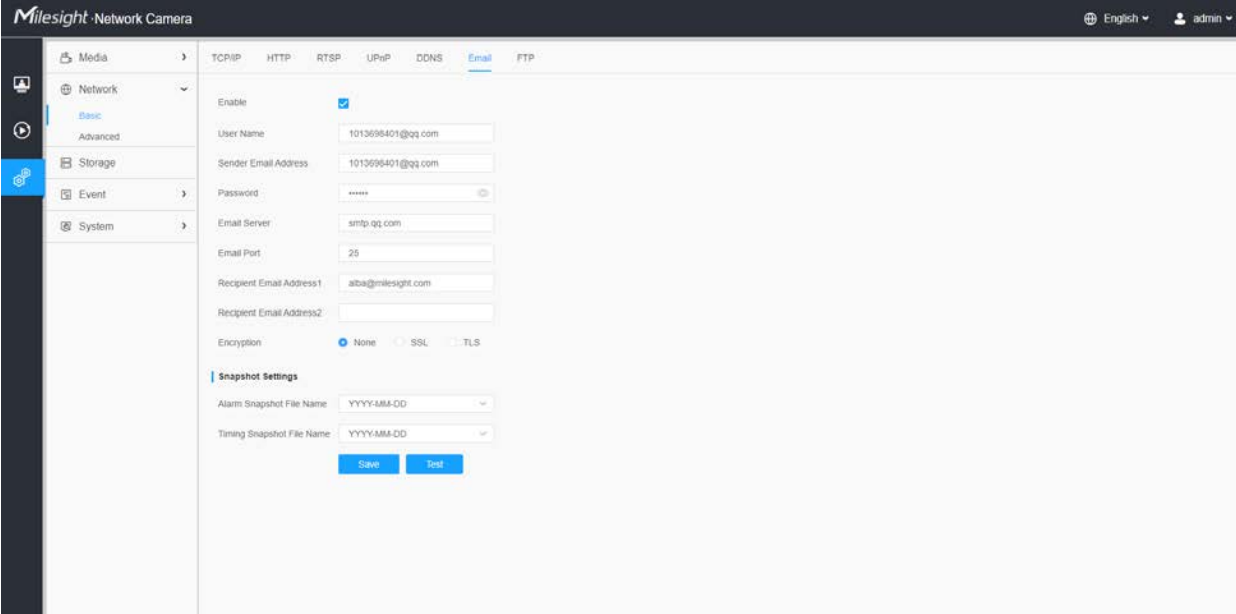



Table 31. Description of the buttons

Parameters	Function Introduction
Enable	Check the checkbox to enable Email function.
User Name	The sender's name. It is usually the same as the account name.
Sender Email Address	Email address to send video files attached emails.

Parameters	Function Introduction
Password	The password of the sender.
Email Server	The email server IP address or host name(e.g. smtp.gmail.com).
Email Port	The default TCP/IP port for SMTP is 25(not secured). For SSL/TLS port, it depends on the mail you use.
Recipient Email Address1	Email address to receive video files.
Recipient Email Address2	Email address to receive video files.
Encryption	Check the checkbox to enable SSL or TLS if it is required by the SMTP server.
Snapshot Settings	<p>Alarm Snapshot File Name: Default(YYYY-MM-DD) /MM-DD-YYYY/ DD-MM-YYYY/ Add prefix/ Overwrite with the base file name/ Customize are available.</p> <p>Timing Snapshot File Name: Default(YYYY-MM-DD) /MM-DD-YYYY/ DD-MM-YYYY/ Add prefix/ Overwrite with the base file name/ Customize are available.</p>
Save	Save the configuration.
Test	Test whether the configuration is successful.

 **Note:** You can refer to the following file name tip to customize the file name.

File Name Tip
 &Device - Device Name
 &Y - Year
 &M - Month
 &D - Day
 &h - hour
 &m - minute
 &s - second
 &ms - millisecond
 && - &

FTP

Alarm video files can be sent to specific FTP server. You must configure the FTP settings correctly before using it.

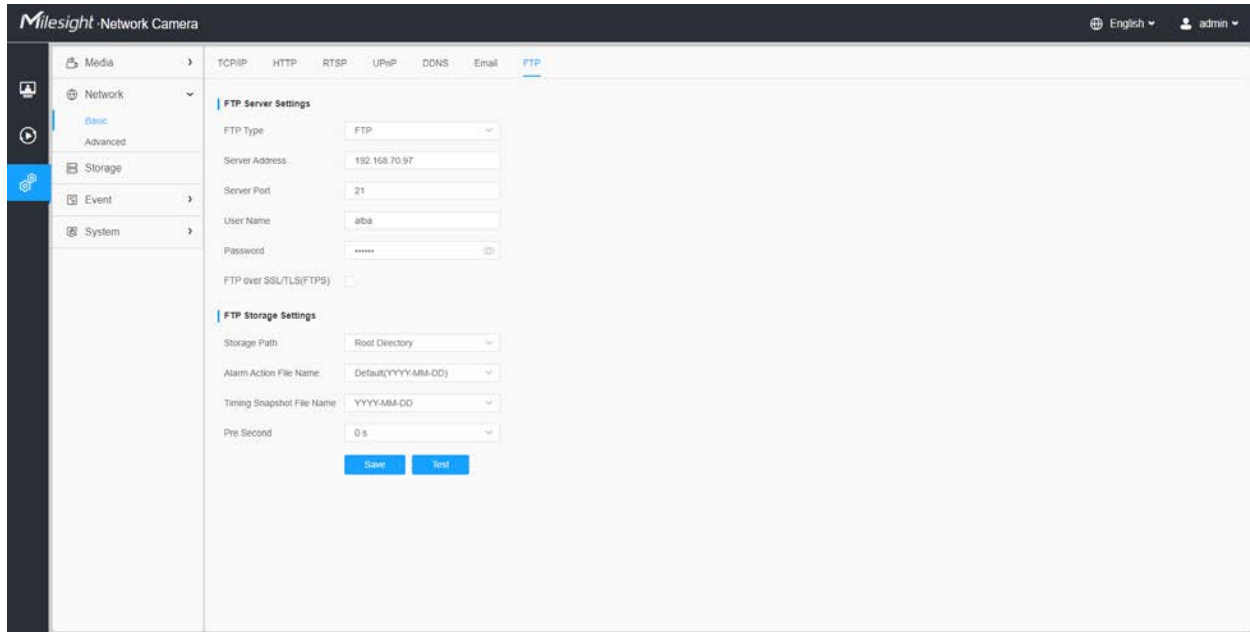

Table 32. Description of the buttons

Parameters		Function Introduction
FTP Server Settings	FTP Type	FTP and SFTP are optional.
	Server Address	FTP/SFTP server address.
	Server Port	The port of the FTP server. Generally it is 21. The port of the SFTP server. Generally it is 22.
	User Name	User name used to log in to the FTP/SFTP sever.
	Password	User password.
FTP Storage Settings	Storage Path	Storage Path where video and image will be uploaded to the FTP server. Four FTP storage path types are available, including Root Directory, Parent Directory, Child Directory and Customize.
	Parent Directory	Choose IP Address/ Device Name/ Date as the folder name of Parent Directory, or customize the folder name.
	Child Directory	Choose IP Address/ Device Name/ Date as the folder name of Child Directory, or customize the folder name.

Parameters		Function Introduction
FTP Storage Settings	Multilevel Folder Name	If the storage path is more than two levels, enter Multilevel FTP storage path here manually.
	Alarm Action File Name	Choose the default(YYYY-MM-DD) or customize the alarm action file name.
	Video File Name	If you choose to customize the alarm action file name, YYYY-MM-DD/ MM-DD-YYYY/ DD-MM-YYYY/ Add prefix are available.
	Image File Name	If you choose to customize the alarm action file name, YYYY-MM-DD/ MM-DD-YYYY/ DD-MM-YYYY/ Add prefix are available.
	Timing Snapshot File Name	Default(YYYY-MM-DD) /MM-DD-YYYY/ DD-MM-YYYY/ Add prefix/ Overwrite with the base file name are available.
	Pre Second	Reserve the record time before alarm, 0~10 sec.
Save		Save the configuration, 0s ~ 10s are optional.
Test		Test whether the configuration is successful.

 **Note:**

- Parent Directory will be under Root Directory, and Child Directory will be under Parent Directory.
- You can refer to the following file name tip to customize the file name.

2.6.2.2 Advanced

VLAN

A virtual LAN (VLAN) is any broadcast domain that is partitioned and isolated in a computer network at the data link layer (OSI layer 2). LAN is an abbreviation of local area network. VLANs allow network administrators to group hosts together even if the hosts are not on the same network switch. This can greatly simplify network design and deployment, because VLAN membership can be configured through software. Without VLANs, grouping hosts according to their resource needs necessitates the labour of relocating nodes or rewiring data links.

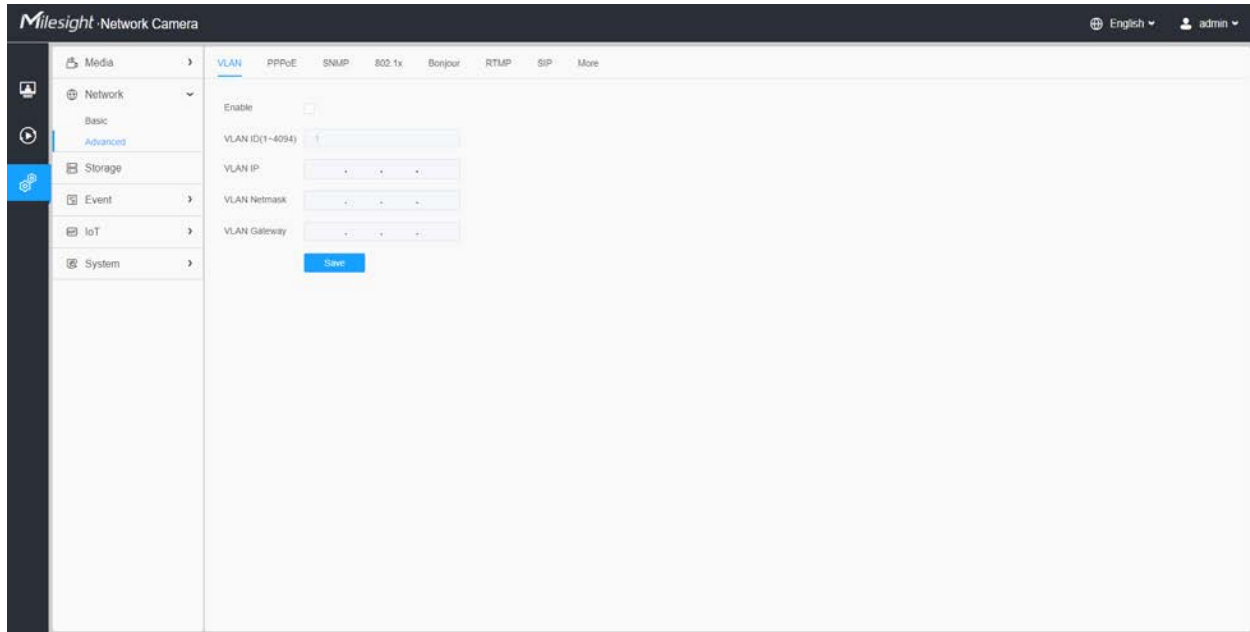

Note: About how to set up VLAN in switches, please refer to your switches user manual.

PPPoE

This camera supports the PPPoE auto dial-up function. The camera gets a public IP address by ADSL dial-up after the camera is connected to a modem. You need to configure the PPPoE parameters of the network camera.

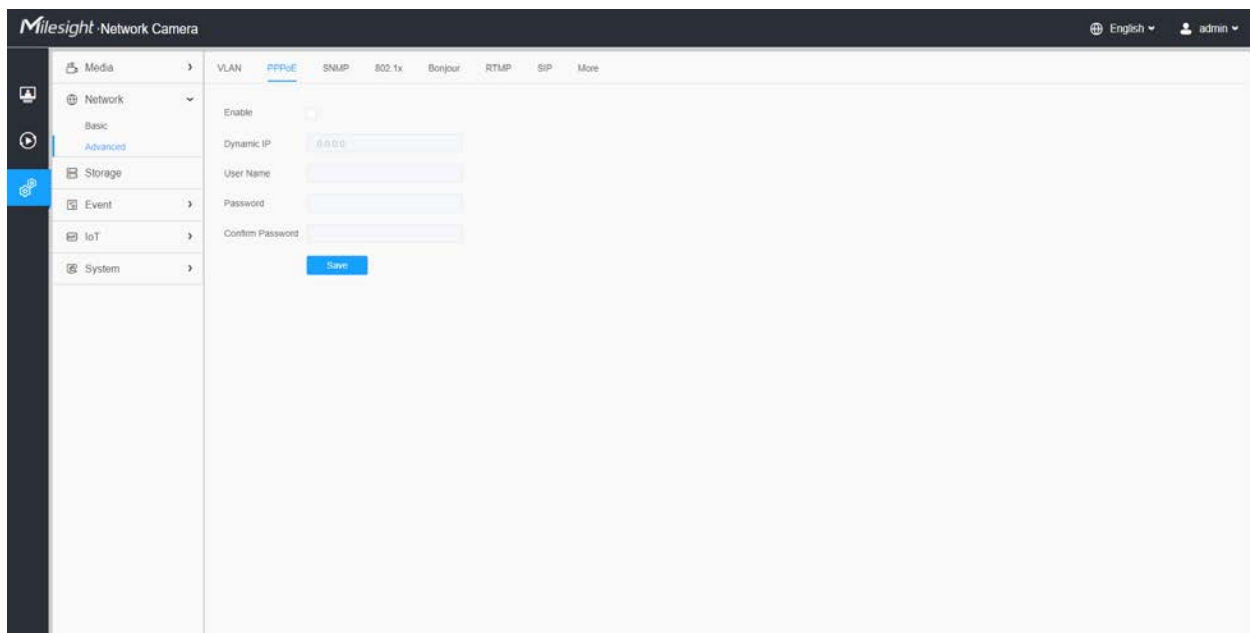

Note:

- The obtained IP address is dynamically assigned via PPPoE, so the IP address always changes after rebooting the camera. To solve the inconvenience of the dynamic IP, you need to get a domain name from the DDNS provider (e.g. DynDns.com).
- The user name and password should be assigned by your ISP.

SNMP

You can set the SNMP function to get camera status, parameters and alarm related information and manage the camera remotely when it is connected to the network.

Before setting the SNMP, please download the SNMP software and manage to receive the camera information via SNMP port. By setting the Trap Address, the camera can send the alarm event and exception messages to the surveillance center.

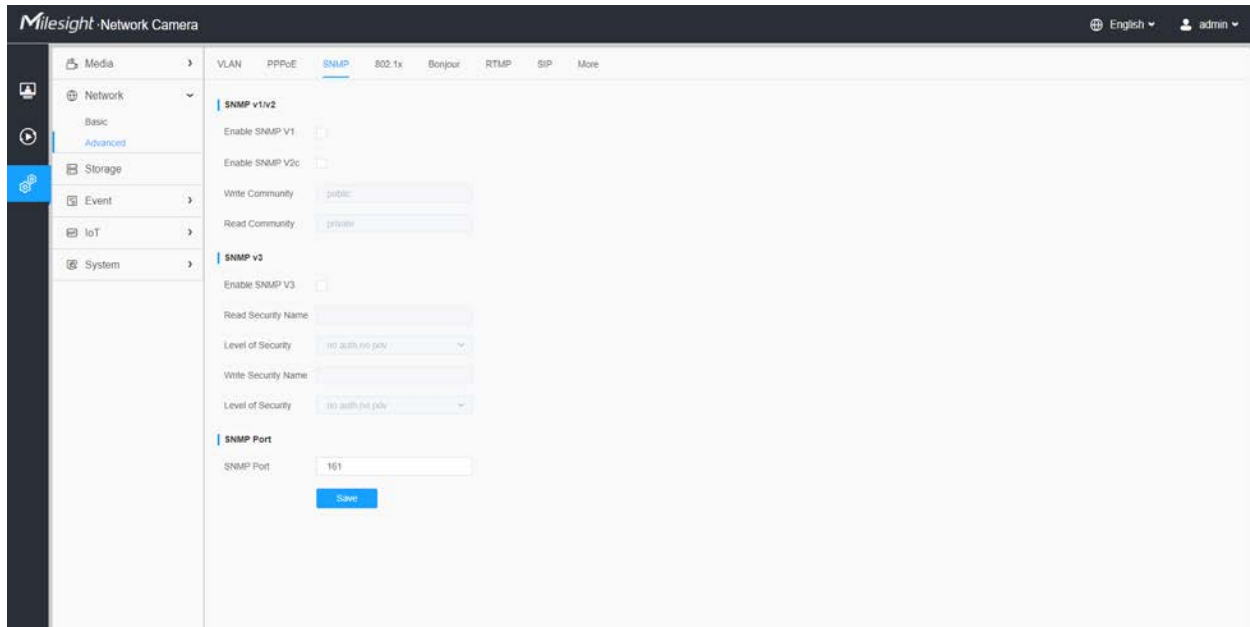

Table 33. Description of the buttons

Parameters	Function Introduction
SNMP v1/v2	<p>The version of SNMP, please select the version of your SNMP software.</p> <p>Enable SNMP v1: Provide no security.</p> <p>Enable SNMP v2: Require password for access.</p> <p>Write Community: Input the name of Write Community.</p> <p>Read Community: Input the name of Read Community</p>

Parameters	Function Introduction
SNMP v3	<p>Enable SNMP v3: Provide encryption and the HTTPS protocol must be enabled.</p> <p>Read Security Name: Input the name of Read Security Community.</p> <p>Level of Security: There are three levels available: (auth, priv), (auth, no priv) and (no auth, no priv).</p> <p>Write Security Name: Input the name of Write Security Community.</p> <p>Level of Security: There are three levels available: (auth, priv), (auth, no priv) and (no auth, no priv).</p>
SNMP Port	The port of SNMP, the default is 161.
Save	Save the configuration.

Note:

- The settings of SNMP software should be the same as the settings you configure here;
- A reboot is required for the settings to take effect.

802.1x

The IEEE 802.1X standard is supported by the network cameras, and when the feature is enabled, the camera data is secured and user authentication is needed when connecting the camera to the network protected by the IEEE 802.1X.

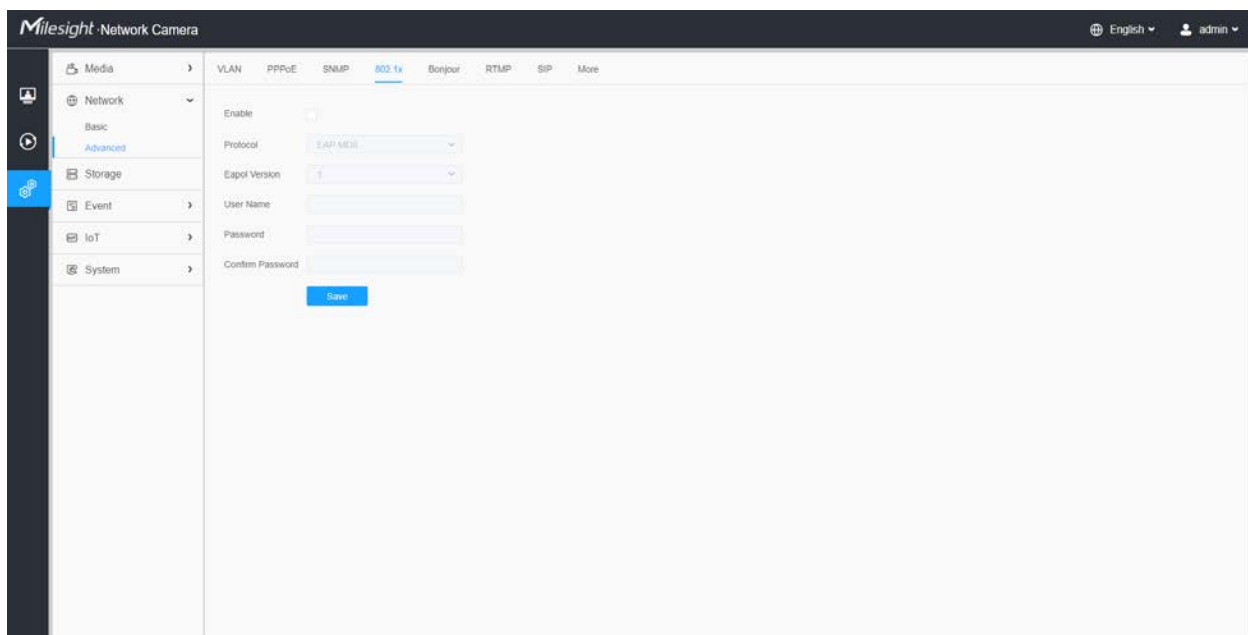

Bonjour

Bonjour is based on Apple's multicast DNS service. Bonjour devices can automatically broadcast their service information and listen to the service information of other devices.

If you don't know the camera information, you can use the Bonjour service on the same LAN to search for network camera devices and then to access the devices.

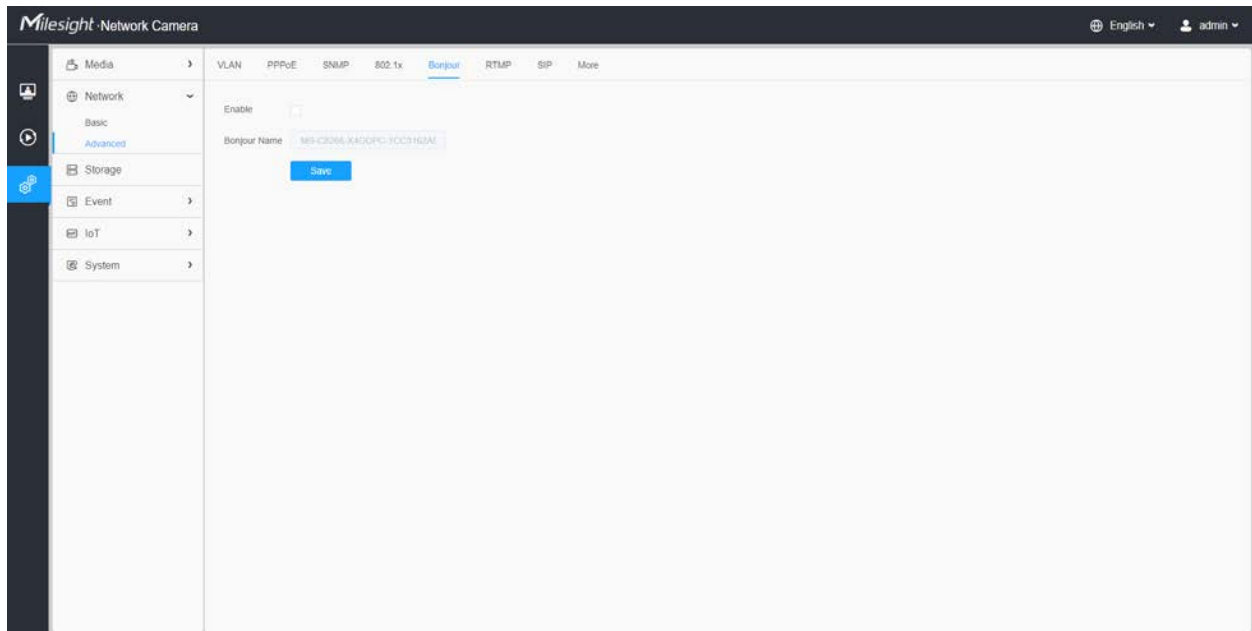

RTMP

Real-Time Messaging Protocol (RTMP) was initially a proprietary protocol for streaming audio, video and data over the Internet, between a Flash player and a server. RTMP is a TCP-based protocol which maintains persistent connections and allows low-latency communication. It can realize the function of live broadcast so that customers can log in to the camera wherever there is a network.

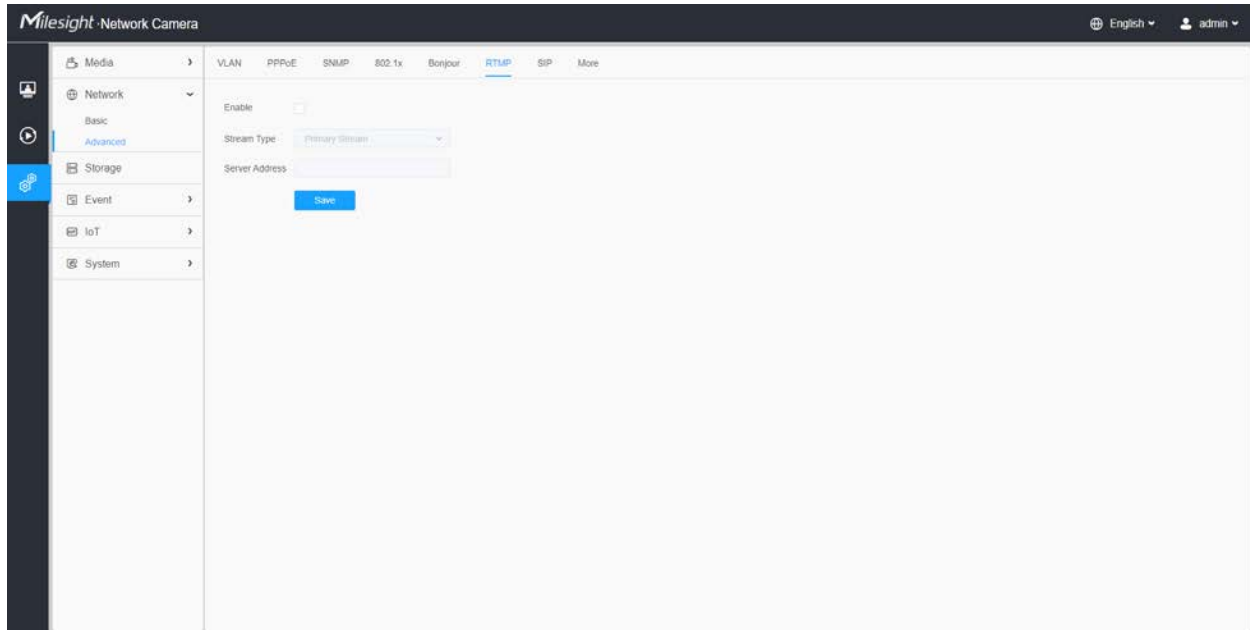

Note:

- For YouTube live broadcast, if you use a newly created account to live broadcast, you need to wait for 24hrs to activate the account for using live function.
- For RTMP, since G.711 is not available for YouTube, so you can only play video from MileSight Network Camera with H.264 video coding and AAC audio coding on YouTube.
- Server Address in Network Camera RTMP interface needs to be filled with the format: `rtmp://< Server URL >/< Stream key >`, remember it needs '/' to connect between < Server URL > and < Stream key >.
- For more details about how to use RTMP for live broadcast, please refer to <https://milesight.freshdesk.com/a/solutions/articles/69000643313>.

SIP

The Session Initiation Protocol(SIP) is a signaling communications protocol, widely used for controlling multimedia communication sessions such as voice and video calls over Internet Protocol (IP) networks. This page allows user to configure SIP related parameters. MileSight Network cameras can be configured as SIP endpoint to call out when alarm triggered; or allow permitted number to call in to check the video if the video IP phone is used.

 **Note:** For more details about how to use SIP, please refer to <https://milesight.freshdesk.com/a/solutions/articles/69000643391>.

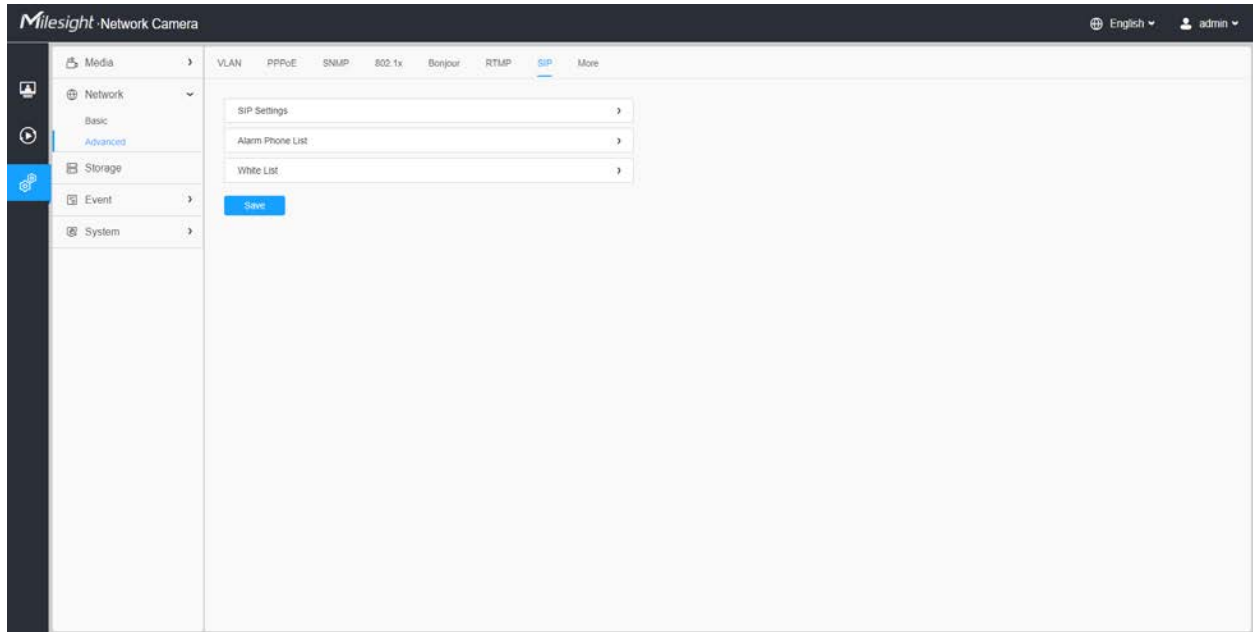

To use this function, the settings in SIP page must be configured properly. There are two ways to get video through SIP, one is to dial the IP address directly, the other is account registration mode. the details are as follows:

Method 1: IP Direct mode

Dial on the camera's IP address directly through SIP phone, so you can see the video.

 **Note:** SIP phone and the camera should in the same network segment.

Method2: Account registration mode

- Before using the SIP, you need to register an account for the camera from the SIP server;
- Register another user account for the SIP device from the same SIP server;
- Call the camera User ID from the SIP device, you will get the video on the SIP device.

[SIP Settings]

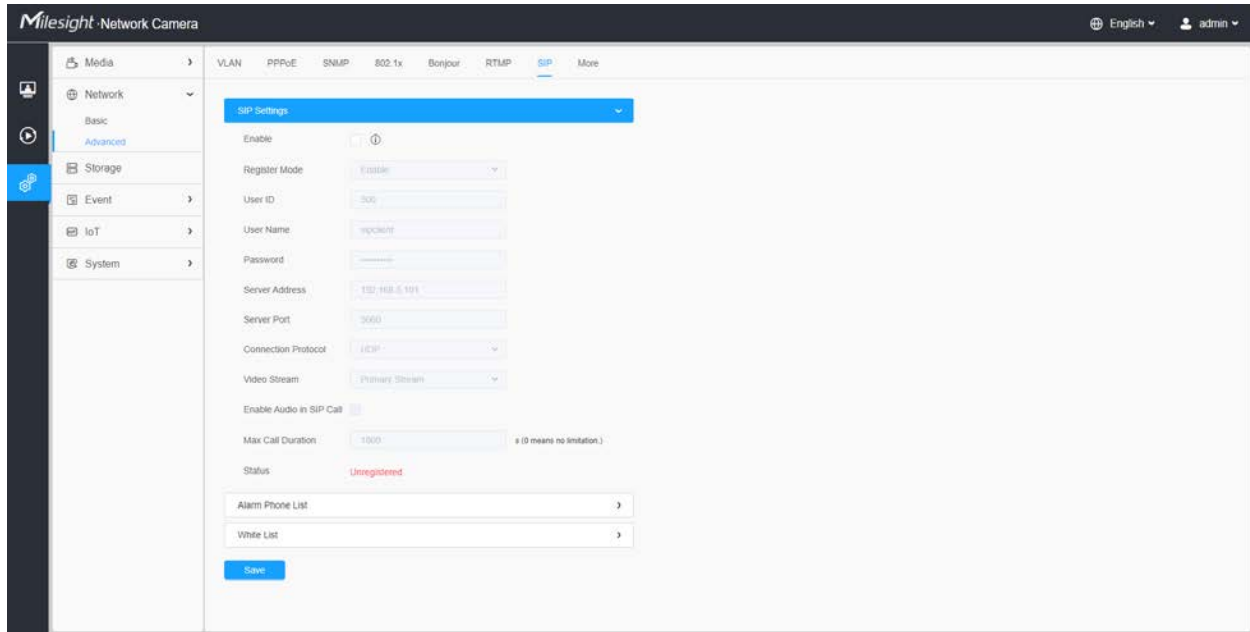



Table 34. Description of the buttons

Parameters	Function Introduction
Enable	Start or stop using SIP.  Note: SIP supports Direct IP call.
Register Mode	Choose to use Enable mode or Disable mode. Enable mode means to use SIP with register account. Disable mode refers to use SIP without register account, just use the IP address to call.
User ID	SIP ID.
User Name	SIP account name.
Password	SIP account password.
Server Address	Server IP address.
Server Port	Server port.
Connection Protocol	UDP/TCP.
Video Stream	Choose the video stream.

Parameters	Function Introduction
Enable Audio in SIP Call	Enable/disable audio in SIP call.
Max Call Duration	The max call duration when use SIP.
Status	SIP registration status. Display “Unregistered” or “Registered” .

[Alarm Phone List]

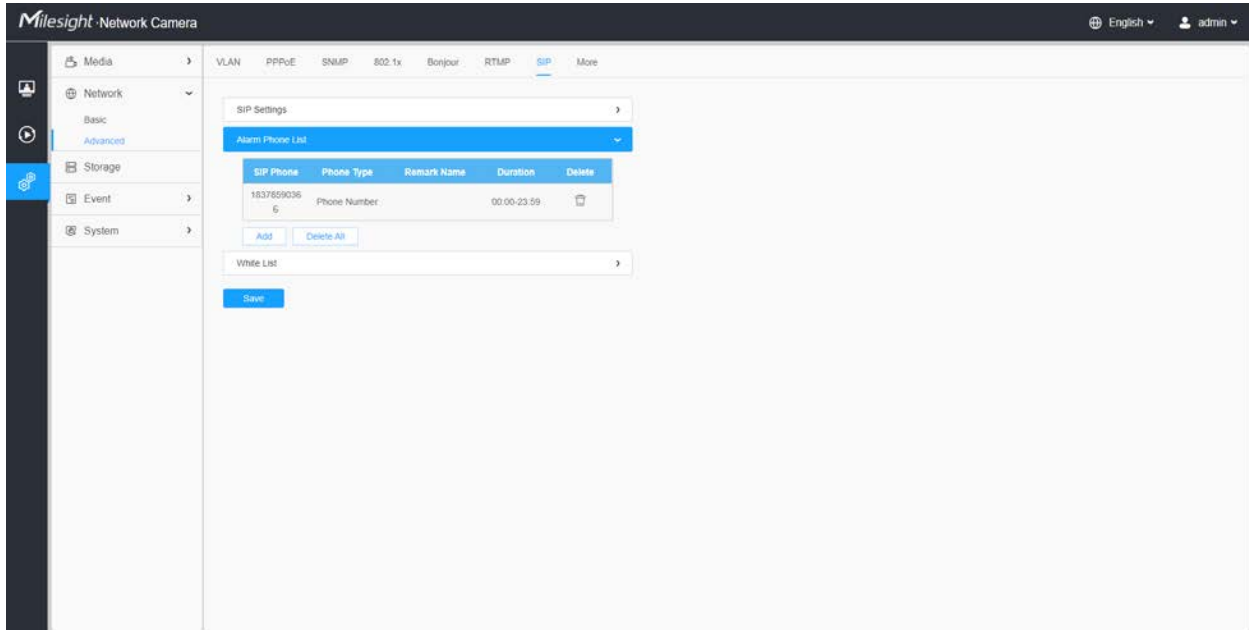
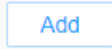

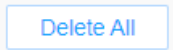

Table 35. Description of the buttons

Parameters	Function Introduction
	<p>Add alarm phone to the camera.</p> <p>Phone Type: Phone Number(Call by phone number) & Direct IP Call(Check to accept peer to peer IP call).</p> <p>To Phone Number/IP Address: Call by phone number or IP address.</p> <p>Remark Name: Display name.</p> <p>Duration: The time schedule to use SIP.</p>
	Delete the selected alarm phone.
	Delete all added alarm phone.

[White List]

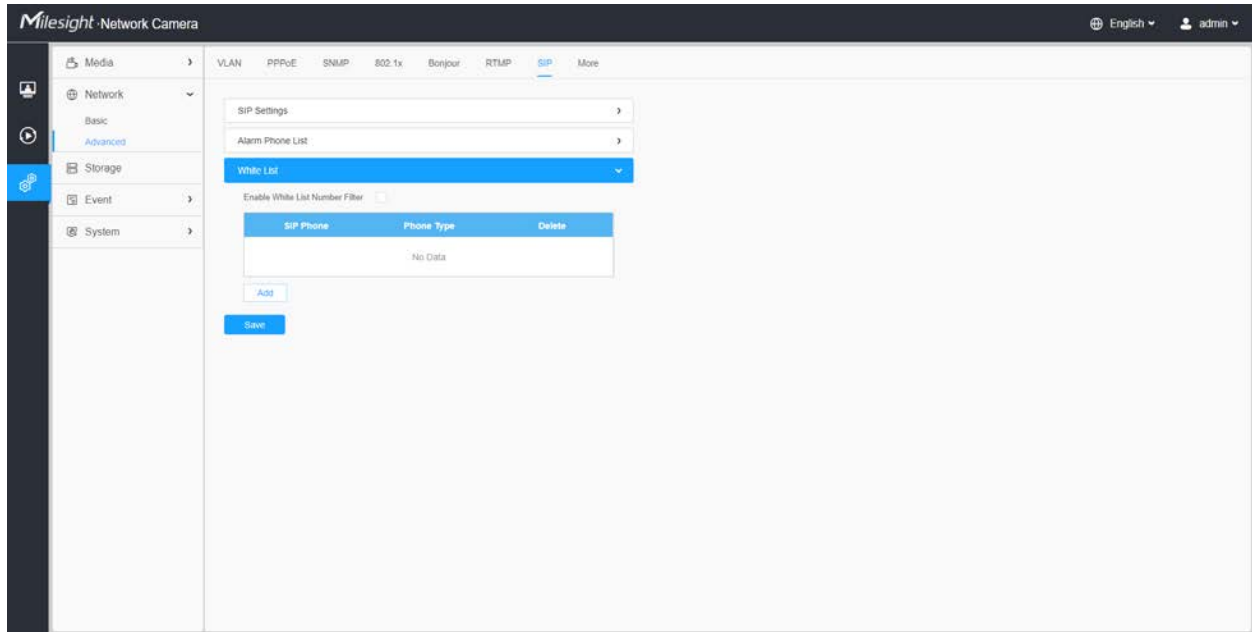
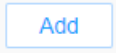

Table 36. Description of the buttons

Parameters	Function Introduction
<p>Enable White List Number Filter</p>	<p>When enabled, only the designated phone number or IP address can visit</p>
<p></p>	<p>Phone Type: Phone Number(Call by phone number) & Direct IP Call. Phone Number/IP Address: Including the phone number or IP address on the white list.</p>

More

Here you can set more functions, like Push Message Settings and ONVIF Settings.

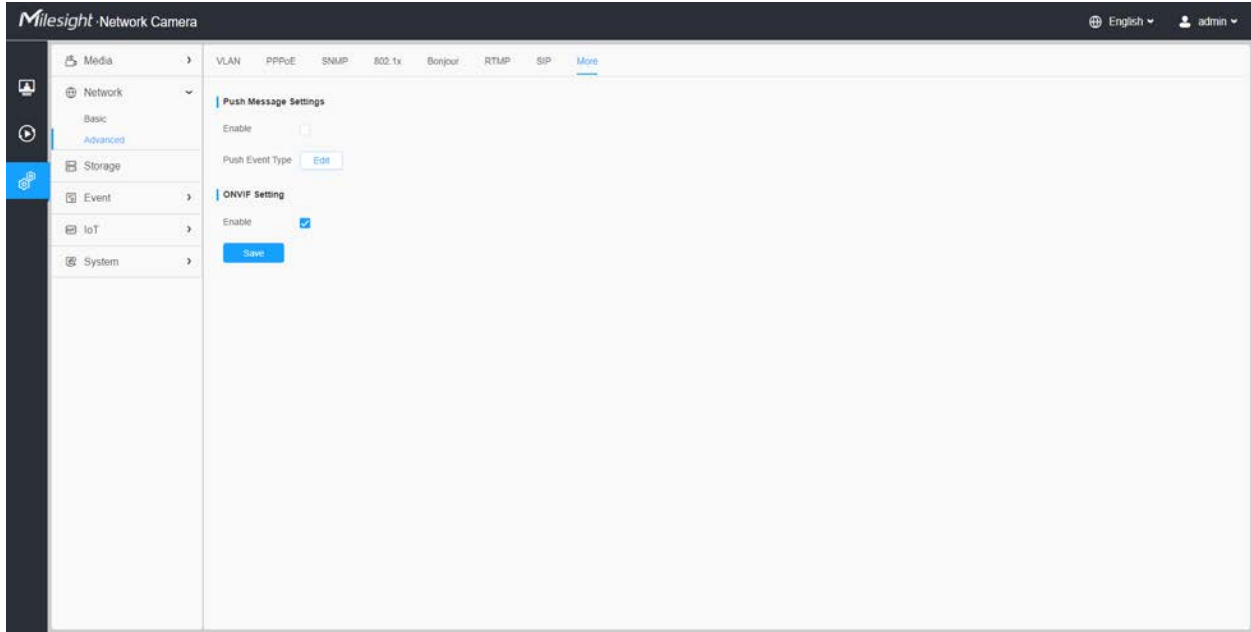

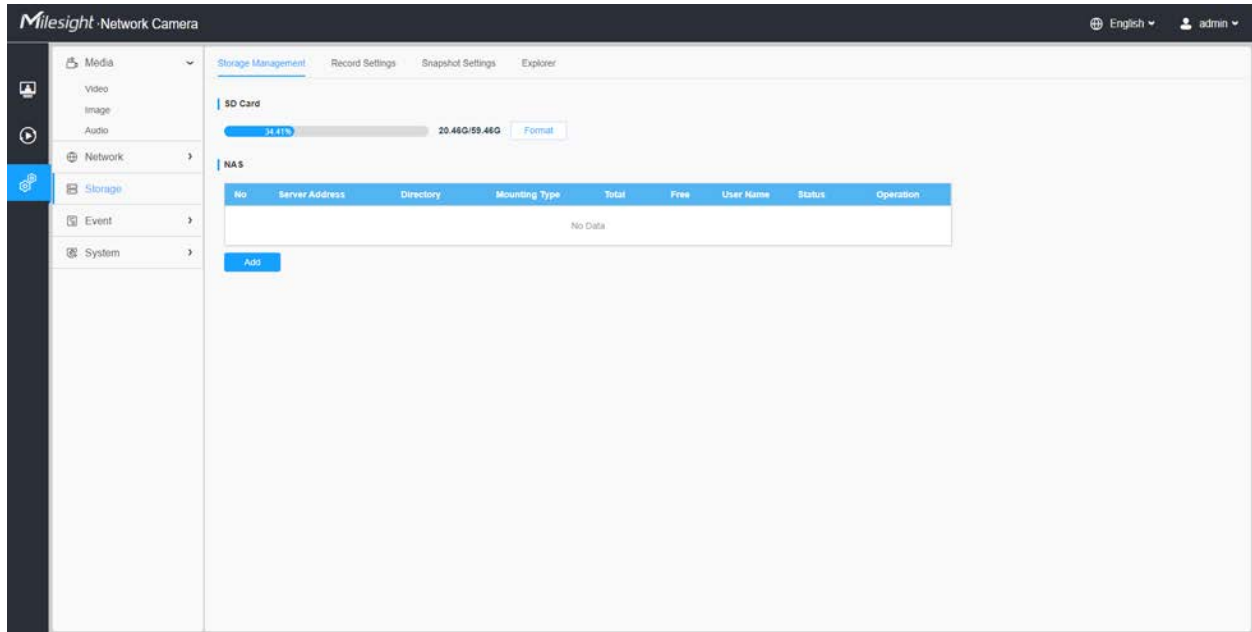

Table 37. Description of the buttons

Parameters	Function Introduction
<p>Push Message Settings</p>	<p>Enable: Enable/disable the Push Message function</p> <p>Push Event Type: You can click  to choose the types of Events' message which will be pushed to M-sight Pro App as shown below:</p> <div data-bbox="574 1142 1373 1501" style="border: 1px solid gray; padding: 10px;"> <p style="text-align: center; background-color: #007bff; color: white; margin: -1px -1px 1px -1px;">Edit ×</p> <p>Push Event Type</p> <p><input checked="" type="checkbox"/> All</p> <p><input checked="" type="checkbox"/> Motion Detection <input checked="" type="checkbox"/> Audio Alarm <input checked="" type="checkbox"/> External Input</p> <p><input checked="" type="checkbox"/> LPR Black <input checked="" type="checkbox"/> LPR White <input checked="" type="checkbox"/> LPR Visitor</p> <p style="text-align: center;"> <input type="button" value="Save"/> <input type="button" value="Cancel"/> </p> </div>
<p>ONVIF Setting</p>	<p>Here you can choose whether to enable or disable camera ONVIF function. If camera ONVIF function is enabled, it can be searched out, added and connected by third-party software through ONVIF protocols. Generally, the default status of ONVIF function is enabled.</p>

2.6.3 Storage

Storage Management



Note: Before you start:

- To configure record settings, please make sure that you have the network storage device within the network or the SD card inserted in your camera.
- Choose the storage mode according to your needs.

Table 38. Description of the buttons

Parameters	Function Introduction
SD Card	<p>Format: Format SD card, the files in SD card will be removed.</p> <p>Mount/UnMount: Mount/Dismount SD card.</p> <p>Delete: Enable cyclic storage, when the free disk space reach at a certain value, it will automatically delete the files at certain percentage according to your settings.</p>

Parameters	Function Introduction
<p style="text-align: center;">Nas</p>	<p>The network disk should be available within the network and properly configured to store the recorded files, etc.</p> <p>NAS (Network-Attached Storage), connecting the storage devices to the existing network, provides data and files services.</p> <div data-bbox="607 459 1403 852" style="border: 1px solid #ccc; padding: 10px; margin: 10px 0;"> <div style="background-color: #007bff; color: white; padding: 5px; text-align: right; display: flex; justify-content: space-between;"> Add × </div> <div style="padding: 10px;"> <p>Server Address* <input type="text"/></p> <p>Directory* <input type="text"/></p> <p>Mounting Type NFS ▼</p> <div style="display: flex; justify-content: center; gap: 10px; margin-top: 10px;"> Save Cancel </div> </div> </div> <p>Server Address: IP address of NAS server.</p> <p>Directory: Input the NAS directory, e.g. “\path”.</p> <p>Mounting Type: NFS and SMB/CIFS are available. And you can set the user name and password to guarantee the security if SMB/CIFS is selected.</p> <p> Note:</p> <ul style="list-style-type: none"> Up to 5 NAS disks can be connected to the camera. For more details about how to use NAS on Milesight Network Camera, please refer to https://milesight.freshdesk.com/a/solutions/articles/69000797902.

Record Settings

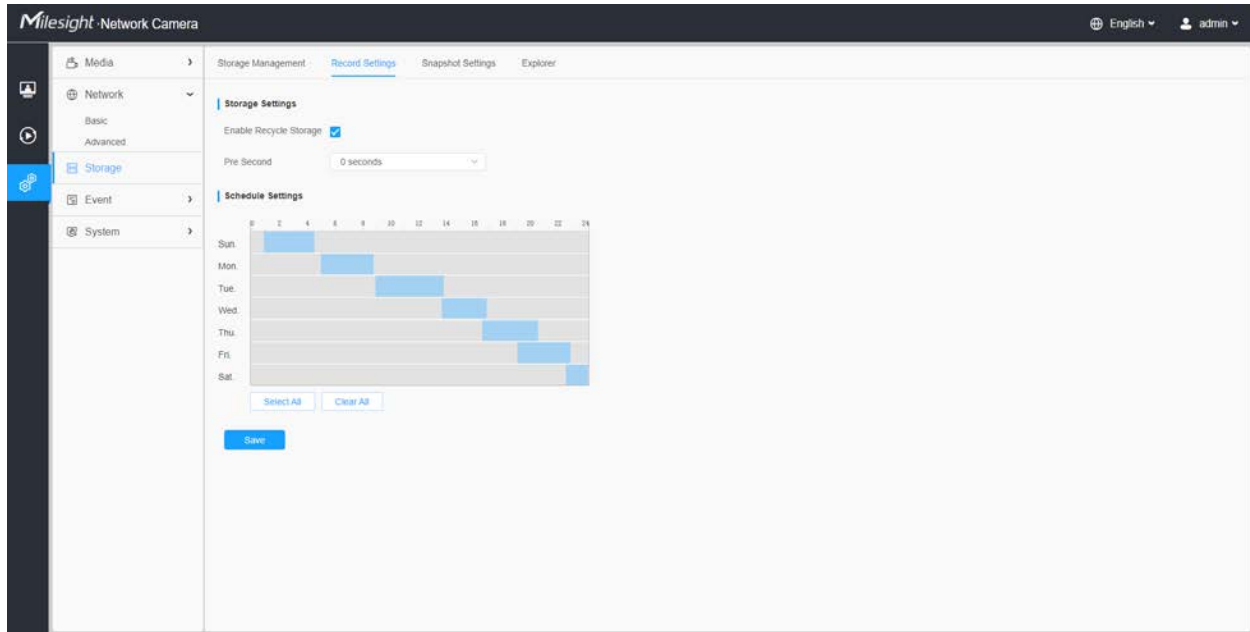
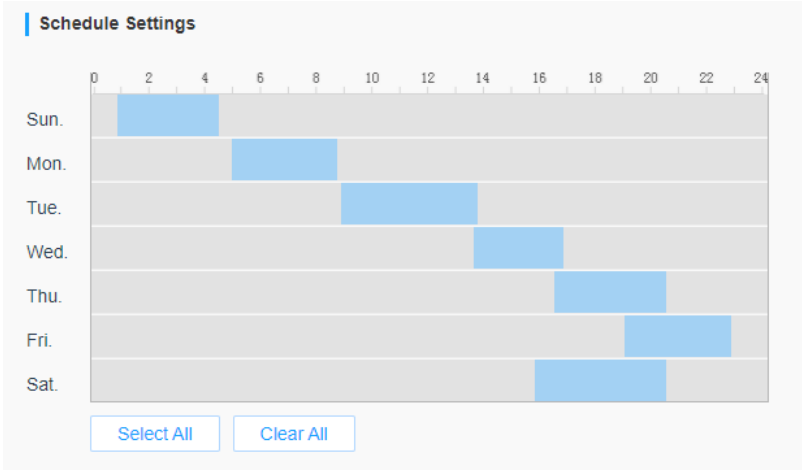
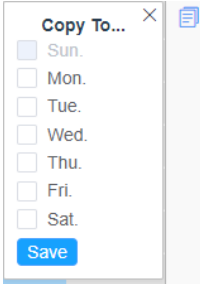
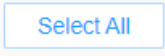
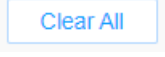



Table 39. Description of the buttons

Parameters	Function Introduction
Enable Recycle Storage	Enable/Disable Recycle Storage, if you enable this option, it will delete the files when the free disk space reaches a certain value.
Pre Second	Reserve the record time before alarm, 0~10 sec.
Schedule Settings	Edit record schedule as needed. Intuitive scheduling by drawing the time bar directly. 

Parameters	Function Introduction	
Schedule Settings		Copy the schedule area to another date.
		Select all schedule.
		Clear all schedule.
	Save the configuration.	

 **Note:** SD Card or NAS are available.

Snapshot Settings

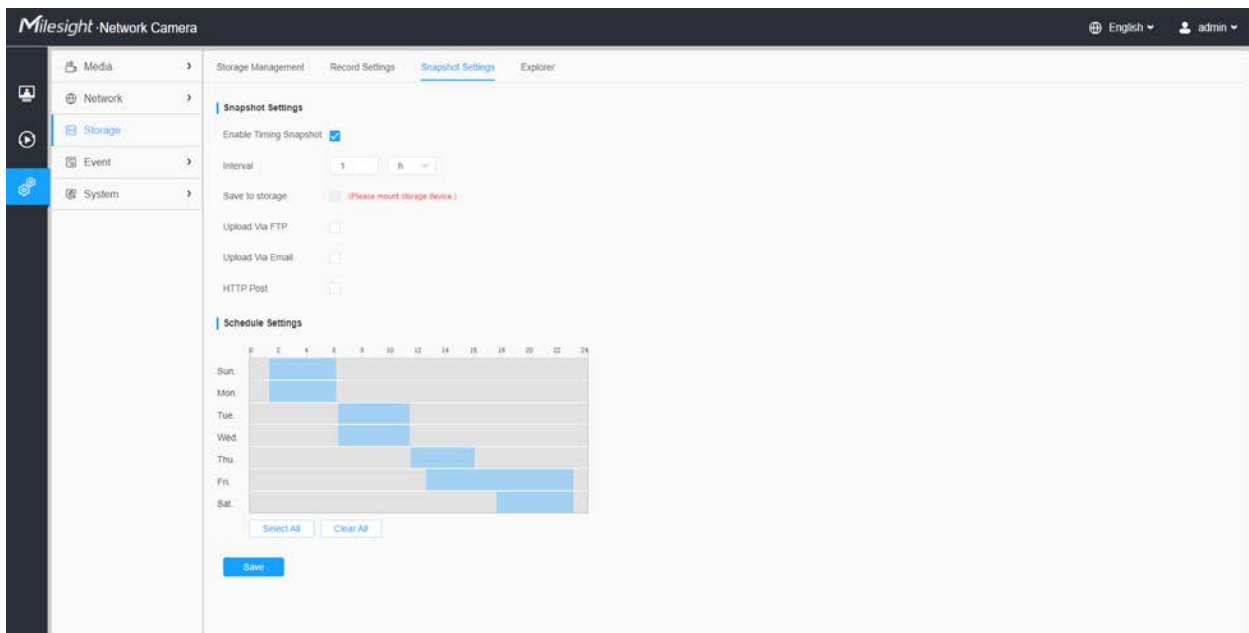
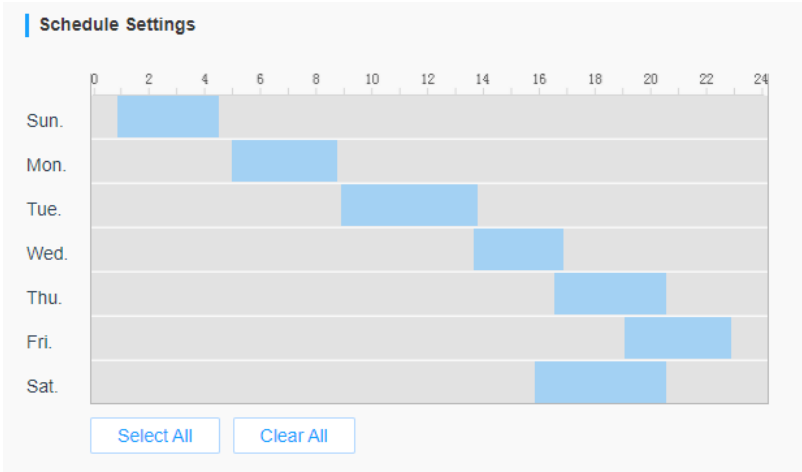
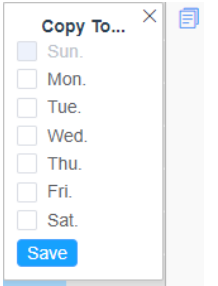
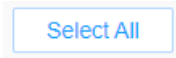



Table 40. Description of the buttons

Parameters	Function Introduction	
<p>Snapshot Settings</p>	<p>Enable Timing Snapshot: Check the checkbox to enable the Timing Snapshot function</p> <p>Interval: Set the snapshots interval, input the number and choose the unit(millisecond, second, minute, hour, day).</p> <p>Save Into Storage: Save the snapshots into SD card or NAS, and choose the file name to add time suffix or overwrite the base file name.</p> <p>Save Into NAS: Save the snapshots into NAS, and choose the file name to add time suffix or overwrite the base file name.</p> <p>Upload Via FTP: Upload the snapshots via FTP.</p> <p>Upload Via Email: Upload the snapshots via Email.</p> <p>Note: If you choose to add time suffix, every snapshot picture will be saved, but if you choose to overwrite the base file name, only one latest picture will be saved. When you choose add overwrite the base file name to SD Card or NAS, it will create a file named "Snapshot" to place the snapshot.</p> <p>HTTP Post: Upload the snapshots via HTTP Post. Support uploading the snapshots to specified HTTP URL.</p>	
<p>Schedule Settings</p>	<p>Edit record schedule as needed. Intuitive scheduling by drawing the time bar directly.</p> 	
<p>Schedule Settings</p>		<p>Copy the schedule area to another date.</p>
		<p>Select all schedule.</p>

Parameters	Function Introduction	
	<div style="border: 1px solid #ccc; padding: 2px; display: inline-block;">Clear All</div>	Clear all schedule.
<div style="background-color: #007bff; color: white; padding: 5px; display: inline-block;">Save</div>	Save the configuration.	

Explorer

Files will be seen on this page when they are configured to save into SD card or NAS. You can set time schedule every day for recording videos and save video files to your desired location.

 **Note:** Files are visible once SD card is inserted. Don't insert or pull out SD card when power on

Video files are arranged by date. Set file type and start/end time to search out files. Each day files will be displayed under the corresponding date, from here you can copy and delete files etc. You can visit the files in SD card by ftp, for example, ftp://username:password@192.168.5.190(user name and password are the same as the camera account and the IP followed is the IP of your device.).

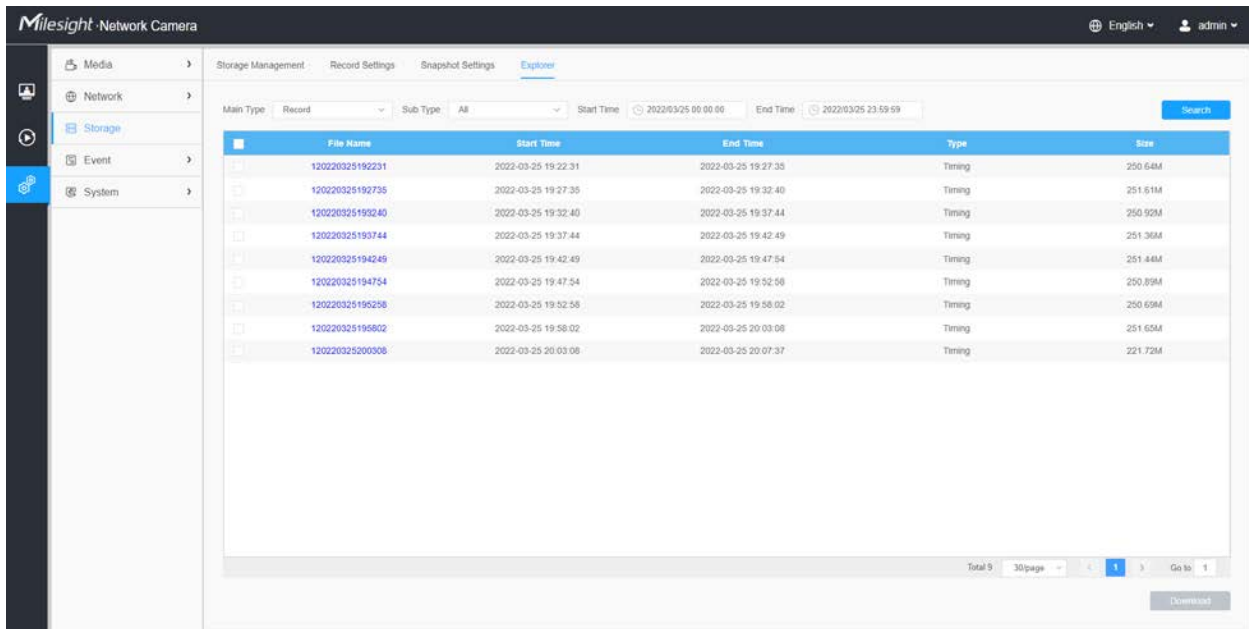

The screenshot shows the 'Explorer' view in the MileSight Network Camera web interface. The interface includes a sidebar with navigation options (Media, Network, Storage, Event, System) and a main content area. The main area displays a table of recorded files with the following columns: File Name, Start Time, End Time, Type, and Size. The table contains 9 rows of data, all of which are 'Timing' type files recorded on 2022-03-25. The file names are unique identifiers, and the start and end times are in HH:MM:SS format. The sizes range from 221.72M to 250.64M. At the bottom of the table, there is a pagination control showing 'Total 9', '30/page', and 'Go to 1'. A 'Download' button is also visible at the bottom right of the table area.

File Name	Start Time	End Time	Type	Size
120220325192231	2022-03-25 19:22:31	2022-03-25 19:27:35	Timing	250.64M
120220325192735	2022-03-25 19:27:35	2022-03-25 19:32:40	Timing	251.51M
120220325193240	2022-03-25 19:32:40	2022-03-25 19:37:44	Timing	250.92M
120220325193744	2022-03-25 19:37:44	2022-03-25 19:42:49	Timing	251.36M
120220325194249	2022-03-25 19:42:49	2022-03-25 19:47:54	Timing	251.44M
120220325194754	2022-03-25 19:47:54	2022-03-25 19:52:58	Timing	250.89M
120220325195258	2022-03-25 19:52:58	2022-03-25 19:58:02	Timing	250.69M
120220325195802	2022-03-25 19:58:02	2022-03-25 20:03:06	Timing	251.65M
120220325200306	2022-03-25 20:03:06	2022-03-25 20:07:37	Timing	221.72M

2.6.4 Event

2.6.4.1 Basic Event

Motion Detection

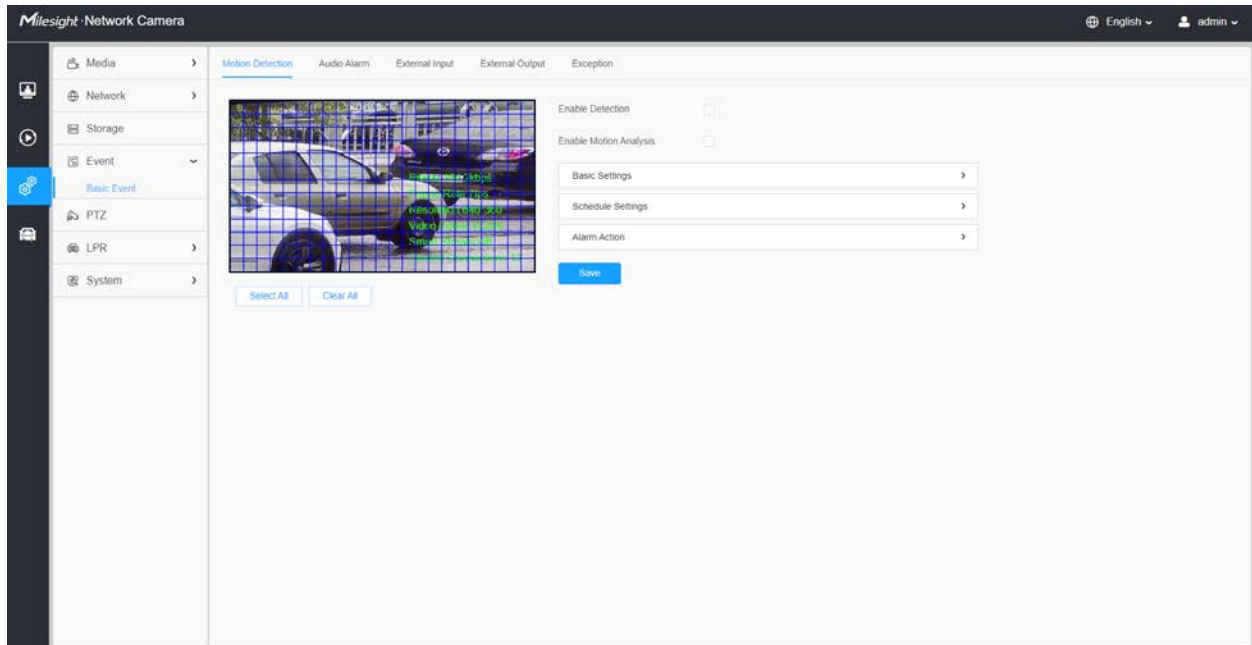

 **Note:** For more details about how to set motion detection, please refer to <https://milesight.freshdesk.com/a/solutions/articles/69000643423>.

Settings steps are shown as follows:

Step1: Check the checkbox to enable the motion detection.



Step2: Check the check box to enable the motion analysis.

Step3: Select the detection mode;

Step4: Set motion region;

Table 41. Description of the buttons

Parameters	Function Introduction
Enable Detection	Check the checkbox to enable Motion Detection function.

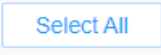
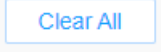
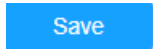
Parameters	Function Introduction
<p>Enable Motion Analysis</p>	<p>When Motion Analysis is enabled, the moving region will turn yellow so that the user can know exactly where the motion occurred.</p> <p> Note: Only support when HTTP is selected in Live View.</p> 
<p></p>	<p>Click the button, the motion in the area will be detected.</p>
<p></p>	<p>Click the button, the area drawn before will be removed.</p>
<p></p>	<p>Save the configuration.</p>

[Basic Settings]

Enable Detection

Enable Motion Analysis

Basic Settings ▾

Mode Normal Mode Advanced Mode

Sensitivity 9

Onvif Motion ActiveCells Settings

Schedule Settings >

Alarm Action >



Table 42. Description of the buttons

Parameters	Function Introduction
Detection Mode	Normal Mode and Advanced Mode are available for the option. When Advanced Mode is selected, users can configure up to 4 detection regions and sensitivity for each detection region.
Sensitivity	Sensitivity level, 1~10
Onvif Motion ActiveCells Settings	Normal and Compatible are available for the option. If the setting of motion region of the third-party software is different from ours, please set this option to Compatible

[Schedule Settings]

Step5: Set motion detection schedule;

Enable Detection

Enable Motion Analysis

Basic Settings >

Schedule Settings v

0 2 4 6 8 10 12 14 16 18 20 22 24

Sun.

Mon.

Tue.

Wed.

Thu.

Fri.

Sat.

Select All Clear All

Alarm Action >

Save

Table 43. Description of the buttons

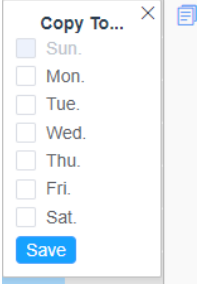
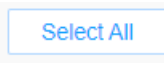
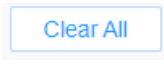
Parameters	Function Introduction
	<p>Copy the schedule area to another date.</p>
	<p>Select all schedule.</p>
	<p>Clear all schedule.</p>

[Alarm Action]

Step6: Set alarm action;

Enable Detection

Enable Motion Analysis

Basic Settings >

Schedule Settings >

Alarm Action ▾

Record >

Snapshot >

External Output >





Play Audio (Please enable the Audio Speaker.)

Alarm to SIP Phone (Please open the SIP.)

HTTP Notification >

Save

Table 44. Description of the buttons

Parameters	Function Introduction
Record	<p>Duration: Selected the duration time of alarm. 5s/10s/15s/20s/25s/30s are available.</p> <p>Linkage: Save alarm recording files into SD Card or NAS or Upload the recording files via FTP.</p>
Snapshot	<p>Number: The number of snapshot, 1~5 are available.</p> <p>Interval: This cannot be edited unless you choose more than 1 to Snapshot.</p> <p>Linkage: Save alarm recording files into SD Card or NAS, Upload the recording files via FTP and send alarm email.</p>
External Output	If the camera equips with External Output, you can enable the action after configuring the trigger duration.
Play Audio	<p>Auto/10 seconds/30 seconds/1 minute/5 minutes/10 minutes are available.</p> <p> Note: Please enable the Audio Speaker.</p>
Alarm to SIP Phone	Support to call the SIP phone after enable the SIP function.
HTTP Notification	<p>Support to pop up the alarm news to specified HTTP URL.</p> <p> Note:</p> <ul style="list-style-type: none"> • Three HTTP notifications at most can be added to the same event. • HTTP Notification supports Basic & Digest authentication
White LED	<p>When the alarm triggered, White LED will turn on to warn the detected objects.</p> <p> Note: Only for PTZ Bullet.</p>
PTZ Motion	<p>When the motion alarm triggered, PTZ Motion allows the camera move the lens to the motion triggered position and zoom in.</p> <p> Note: Only for PTZ series.</p>
Call Preset/ Call Patrol/Call Pattern (Only for External Input)	<p>When the motion alarm triggered, the specified preset/patrol/pattern can be called.</p> <p> Note: Only for PTZ series.</p>

Audio Alarm

Check the check box to enable the Audio Alarm function.

 **Note:** Enable the Audio Mic before using Audio Alarm function.

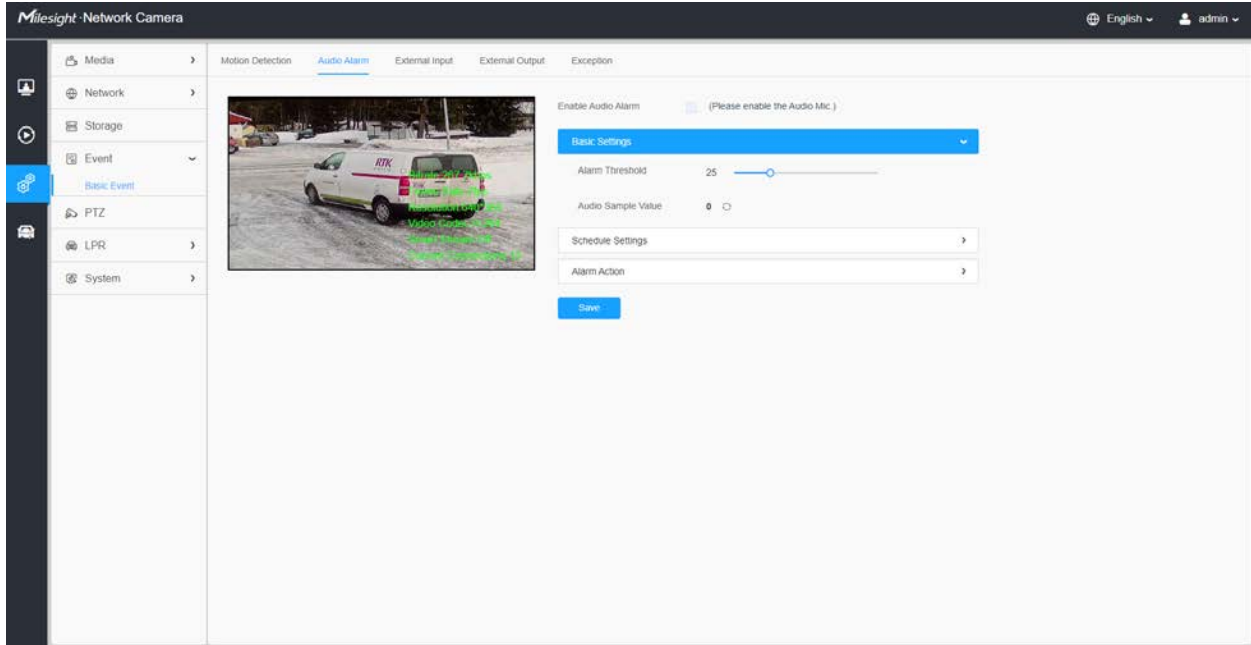

[Basic Settings]

Table 45. Description of the buttons

Parameters	Function Introduction
Alarm Threshold	Audio Alarm will be triggered when the thresholds reaches to a certain value from 0 to 100.
Audio Sample Value	The current value of the audio sample.

[Schedule Settings]

Refer to the table [Table 3 \(page 85\)](#) for the meanings of the items, here will not repeat again.

[Alarm Action]

Refer to the table [Table 4 \(page 86\)](#) for the meanings of the items, here will not repeat again.

External Input

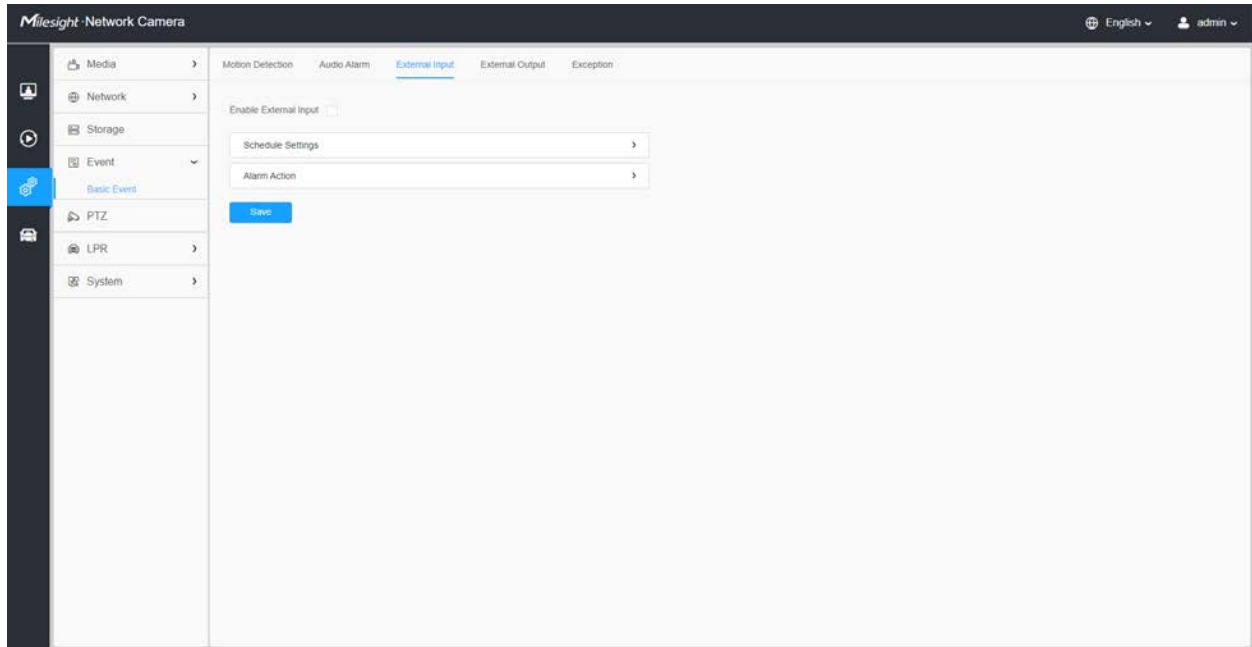

Refer to the table [Table 3 \(page 85\)](#) for the meanings of the items, here will not repeat again.

External Output

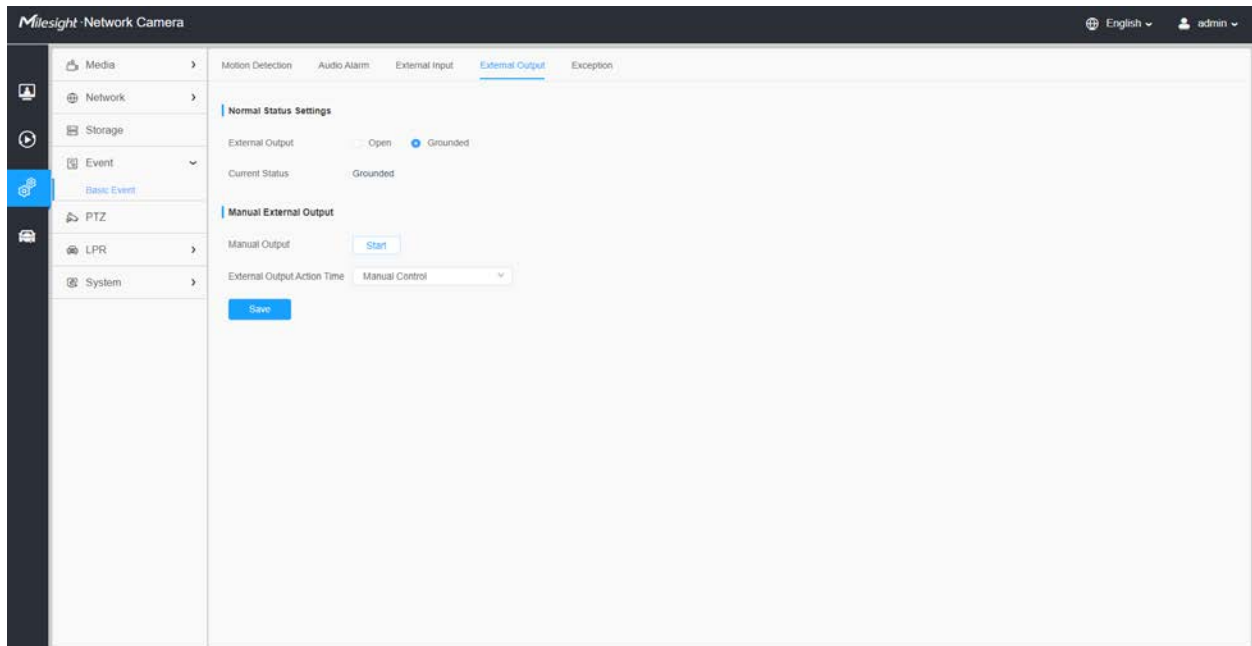

[Normal Status Settings]

Please set the **Normal Status** firstly, when the **Current Status** is different with **Normal Status**, it will lead to the alarm.

[Manual External Output]

You can set the manual external output.

Table 46. Description of the buttons

Parameters	Function Introduction
Manual Output	Click to Start/Stop manual external output.
External Output Action Time	Manual Control/Customize/10 s/1 min./5 min./10 min. are available.

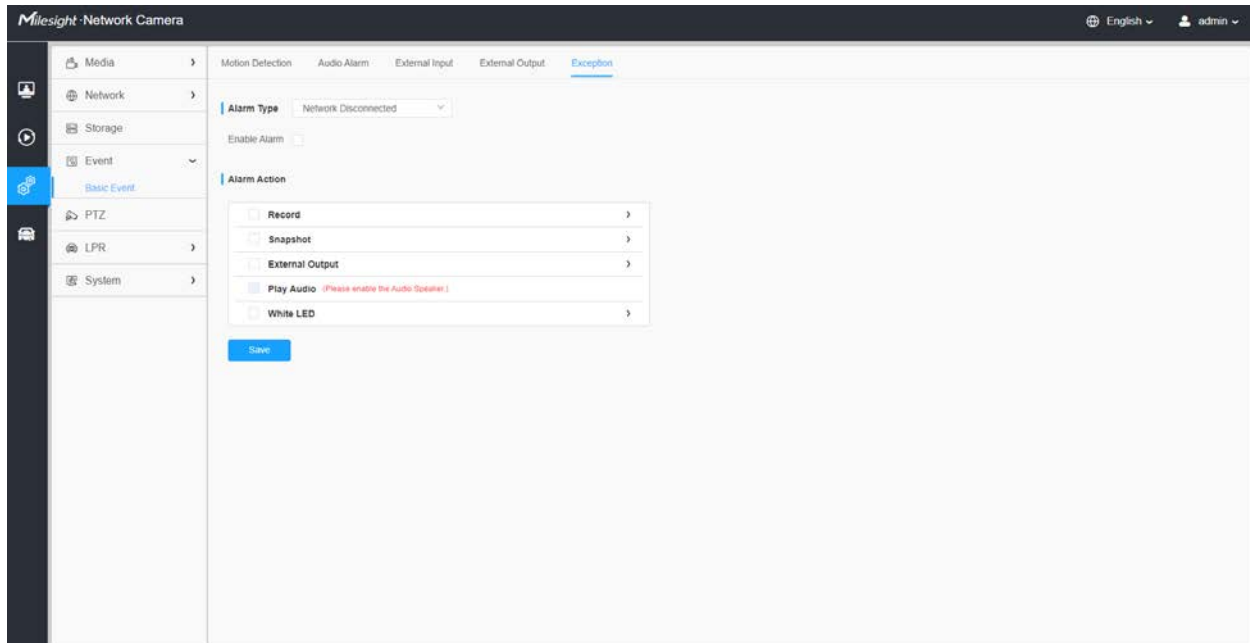
Exception**Table 47. Description of the buttons**

Parameters	Function Introduction
Alarm Type	Network Disconnected, IP Address Conflicted, Record Failed, SD Card Full, SD Card Uninitialized, SD Card Error and No SD Card are available Check the checkbox to enable the alarm type you selected
Alarm Action	Refer to the table Table 3 (page 85) for the meanings of the items, here will not repeat again.

2.6.5 LPR

Settings

The LPR function will automatically detect and capture license plate in real time and compares to a predefined list, then takes appropriate action such as generating an alert once the license plate is on the predefined black list.

Currently we have several LPR versions, **LPR1, LPR2, LPR3, LPR 4, LPR EU, LPR AP, LPR AM and LPR_ME**. LPR_EU, LPR2 are for European. LPR1 and LPR_AP are for Asia&Pacific. LPR4 and LPR_AM are for America. LPR3 is for Korea. LPR_ME is for Middle East.

Before you start, please enter a license to activate the LPR function on System info interface. When the License Status changes to Valid, the camera can start detecting the license plates.

Note:

- The LPR1 version does not require a license.
- For more details about how to set ANPR solution, please refer to <https://milesight.freshdesk.com/a/solutions/articles/69000640021>.
- For more details about how to set LPR1, please refer to <https://milesight.freshdesk.com/a/solutions/articles/69000797908>.
- For more details about how to set LPR2, please refer to <https://milesight.freshdesk.com/a/solutions/articles/69000797905>.
- For more details about how to set LPR3, please refer to <https://milesight.freshdesk.com/a/solutions/articles/69000797904>.

General

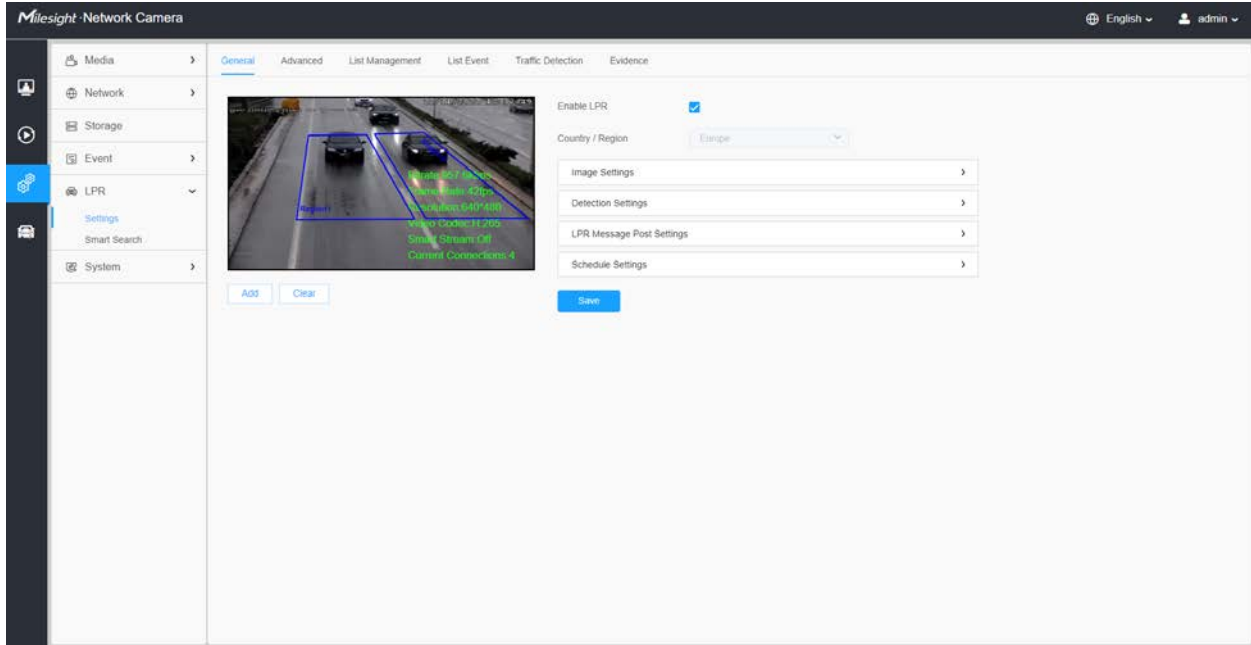

Table 48. Description of the buttons

Parameters	Function Introduction
Enable Detection	Enable/disable the LPR detection function.
Country/ Region (Only for LPR1, LPR4, LPR_AP and LPR_AM)	Select country/ region to detect the license plate.
Effective Region (Only for PTZ series)	Normal: configure the LPR detection regions for the current area. Advanced: configure different LPR detection regions for different PTZ presets(Only support Preset 1~4 so far).

Step1: Check the check box to enable the LPR detection function. Select country/ region to detect the license plate.

[Image Settings]

Step2: The LPR Night Mode supports the optimal LPR night recognition effect by adjusting different parameter levels. You can choose Customize to set effective time manually, or choose Auto Mode which can automatically switch to night mode according to illumination intensity.

Table 49. Description of the buttons

Parameters	Function Introduction
Enable LPR Image Mode	To enable LPR Image Mode, parameters of Backlight, Exposure and Day/Night Switch will be set to special values.
Level	Level 1~5 are available.  Note: Minimum Shutter of each Level : 1- 1/250, 2- 1/500, 3- 1/750, 4- 1/1000, 5- 1/2000.

[Detection Settings]

Step3: Check the check box “Enable License Plate Recognition”, you can draw the screen to select area interested.

Detection Settings ▼

Detection Region ⓘ

ID	Name	Operation
1	ROI_1	

[Delete All](#)

Detection Settings

Detection Mode Plate Priority Vehicle Priority ⓘ

Detection Trigger ▼

Repeat Plate Checktime ▼ (0-60000)

License Plate Serial Format [Edit](#)

Attributes Identification

- All
- Plate Color Vehicle Type
- Vehicle Color Detection Region
- Direction Country / Region

LPR Message Post Settings
›

Schedule Settings
›

[Save](#)

Note: The detection area can be drawn as an irregular quadrilateral, which greatly enhances the scene adaptability.

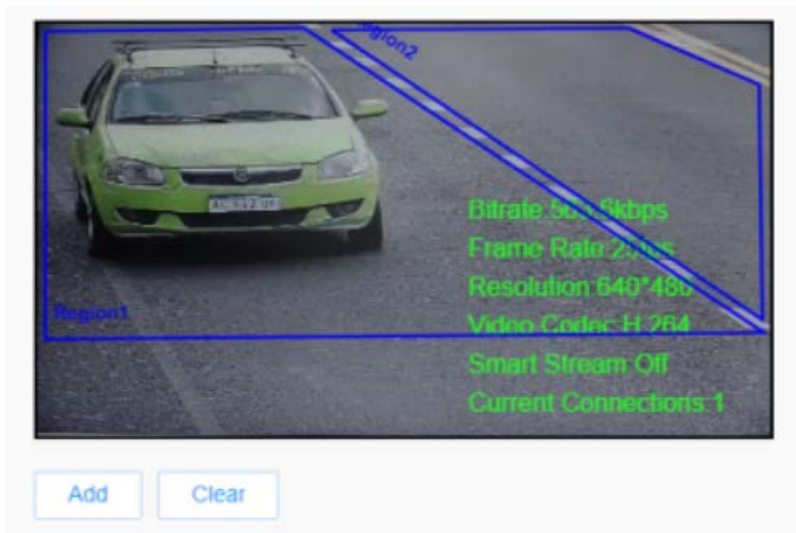



Table 50. Description of the buttons

Parameters	Function Introduction									
Add	<p>Draw the screen to select the area interested, then click “Add” button to add the area, only four recognition areas can be added.</p> <p>You can edit the name of the area or delete the area in the list below.</p> <table border="1"> <thead> <tr> <th>ID</th> <th>Name</th> <th>Operation</th> </tr> </thead> <tbody> <tr> <td>1</td> <td>ROI_1</td> <td> </td> </tr> <tr> <td>2</td> <td>ROI_2</td> <td> </td> </tr> </tbody> </table> <p> Note: Only license plates larger than 150 pixels can be recognized.</p>	ID	Name	Operation	1	ROI_1		2	ROI_2	
ID	Name	Operation								
1	ROI_1									
2	ROI_2									
Clear	Click the "Clear" button to clear the area being drawn.									
Delete All	Click the "Delete All" button to delete all the added areas.									

Step4: Set Detection Settings.

Table 51. Description of the buttons

Parameters	Function Introduction
Detection Mode	<p>Plate Priority: Under this mode, the camera will first recognize the license plate and then locate the target as a vehicle with less delay.</p> <p>Vehicle Priority: Under this mode, the camera will first locate the target vehicle and then recognize the license plate to avoid some false detection.</p> <p> Note: Vehicle priority mode can identify vehicles without license plates.</p>

Parameters	Function Introduction
Processing Resolution (Only for LPR1, LPR2, LPR3 and LPR4)	Resolution of the stream for LPR analysis, including 1920*1280, 1280*720, 640*360, 320*176.
Detection Trigger	<p>Always: in this mode, camera will always detect license plates.</p> <p>Alarm Input: in this mode, camera will only detect license plates during Alarm Input is being triggered.</p>
Confidence Level (Only for LPR1, LPR2, LPR3 and LPR4)	You can set the confidence level from 1 to 10. When the confidence level of the license plate is higher than the set confidence level, it will push the license plate image to the logs interface.
Repeat Plate Checktime	<p>Set the time interval for repeatedly reading license plates to effectively avoid duplicate identification of parking vehicles.</p> <p>You can set Repeat Plate Checktime from 0 to 60min or 0 to 60000ms.</p>
License Plate Serial Format	<p>License Plate Serial Format function supports formulating identification rules and can automatically do further processing, filter license plates in non-compliant formats to achieve more intelligent and accurate license plate recognition.</p> <p> Note: It supports up to 10 license plate characters.</p>
Attributes Identification	<p>Check Plate Color, Vehicle Type, Vehicle Color, Detection Region, Direction, Country/Region(Only for LPR2 and LPR_EU), or All to enable Attributes Identification, it will display the corresponding information on the Smart Search interface.</p> <ul style="list-style-type: none"> • Vehicle Type: Car, SUV, Van, Bus, Forklift, Excavator, Tow truck, Truck, Fire engine, Ambulance, Police car, Motorbike, Bicycle, E-Bike and Other • Vehicle Color: Black, White, Gray, Red, Yellow, Green and Blue • Plate Color: Black, White, Red, Yellow, Green and Blue

Step5: Set LPR Message Post Settings.

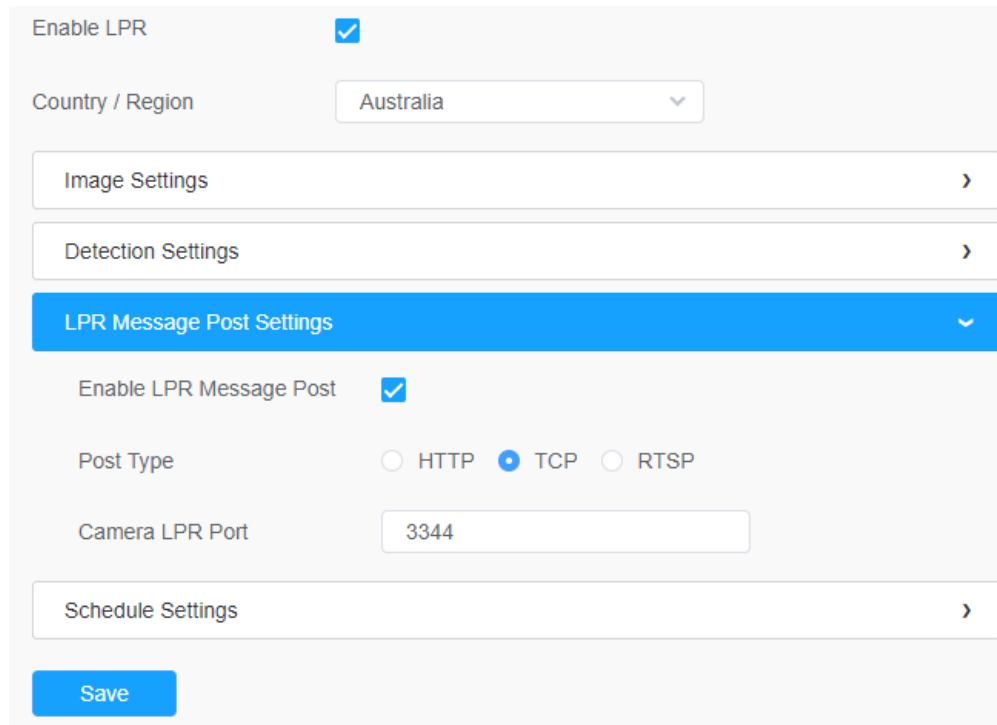

Enable LPR

Country / Region

Image Settings >

Detection Settings >

LPR Message Post Settings v

Enable LPR Message Post

Post Type HTTP TCP RTSP

Camera LPR Port

Schedule Settings >

Save

Table 52. Description of the buttons

Parameters	Function Introduction
Enable LPR Message Post	Check the checkbox to enable LPR Message Post. It will push information to some third-party devices or software that are compatible with ours.
Post Type	Information can be pushed by RTSP , TCP or HTTP .
HTTP Method	There are two HTTP push methods, including Post and Get.
Snapshot Type	Three kinds of snapshot can be chosen: All, License Plate and Full Snapshot. When you choose All, License Plate Snapshot and Full Snapshot will be pushed. Note: This option is available just for Post HTTP Method.
HTTP Notification URL	LPR camera can use the API URL to send LPR information to back-end devices when the license plate is recognized. API URL format fills as below: http://IP:Port/api/lpr?
User Name	Receiver name
Password	Receiver Password

[Schedule Settings]**Step6:** Schedule Settings.

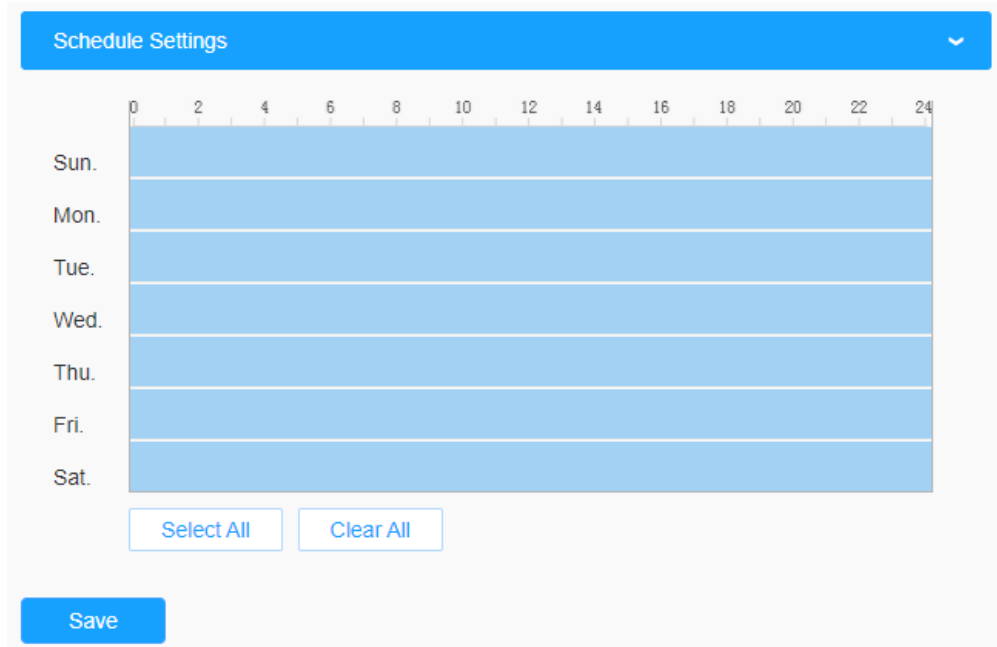
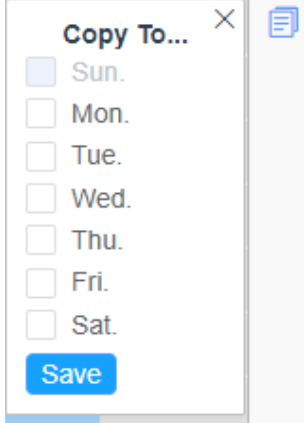

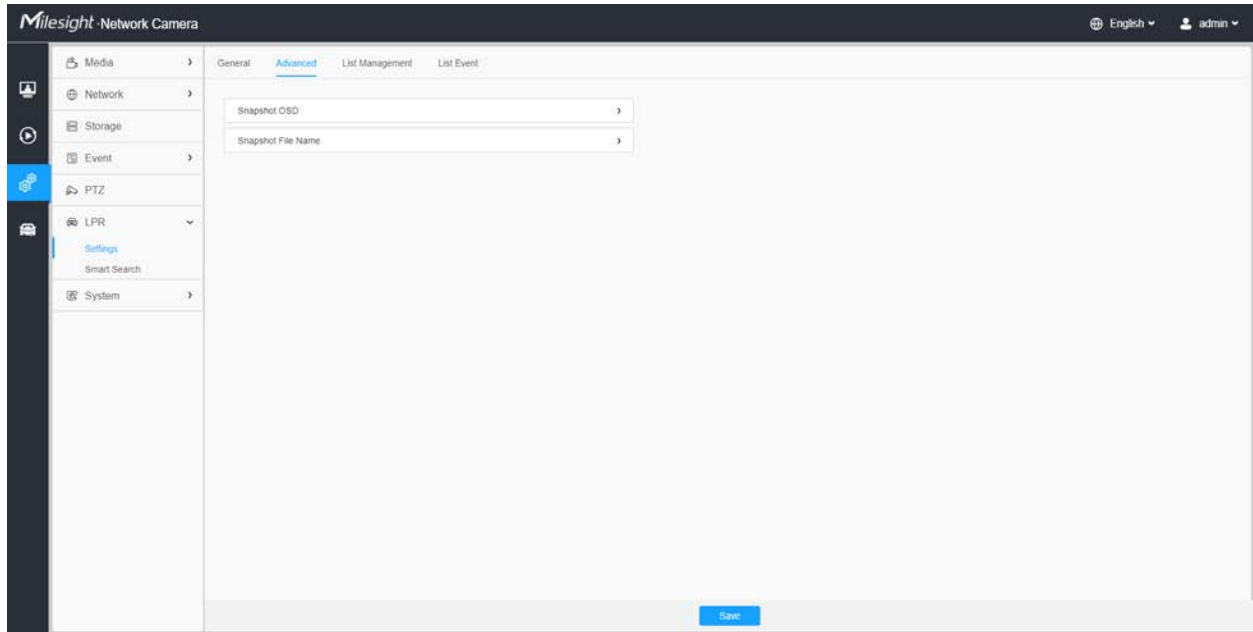

Table 53. Description of the buttons

Parameters	Function Introduction
	<p>Copy the schedule area to another date.</p>
	<p>Select all schedule.</p>
	<p>Clear all schedule.</p>

Advanced

In the interface, you can set display information on snapshot of license plate recognition, and also customize the file name of snapshots which are uploaded via FTP or Email or stored on local LPR Picture File Path.



[Snapshot OSD]

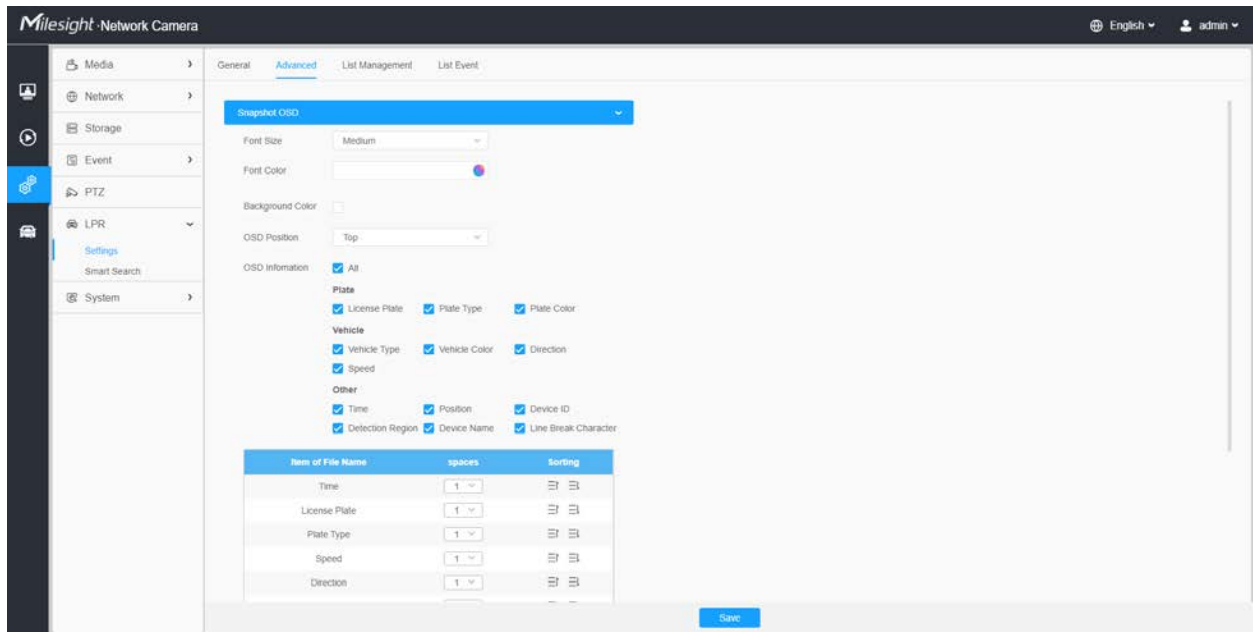





Table 54. Description of the buttons

Parameters	Function Introduction
Font Size	Smallest/Small/Medium/Large/Largest are available for OSD information.  Note: Snapshot OSD font size and Image OSD font size are corresponded.
Font Color	Enable to set different colors for OSD information.  Note: Snapshot OSD font color and Image OSD font color are corresponded.
Background Color	Check the checkbox to select background color of snapshot OSD information.  Note: Background color cannot be the same with font color.
OSD Position	Top/Bottom/Top outside the picture/Bottom outside the picture are available for OSD position.

Parameters	Function Introduction
<p style="text-align: center;">OSD Information</p>	<p>Customize the OSD content. You can set OSD Information as shown below:</p> <div style="border: 1px solid #ccc; padding: 10px; background-color: #f9f9f9; margin: 10px 0;"> <p>OSD Information <input type="checkbox"/> All</p> <p>Plate</p> <p><input type="checkbox"/> License Plate <input type="checkbox"/> Plate Type <input type="checkbox"/> Plate Color</p> <p>Vehicle</p> <p><input type="checkbox"/> Vehicle Type <input type="checkbox"/> Vehicle Color <input type="checkbox"/> Direction</p> <p><input type="checkbox"/> Speed</p> <p>Other</p> <p><input type="checkbox"/> Time <input type="checkbox"/> Position <input type="checkbox"/> Device ID</p> <p><input type="checkbox"/> Detection Region <input type="checkbox"/> Device Name <input type="checkbox"/> Line Break Character</p> </div> <p>When license plate is recognized and the alarm is triggered, the snapshot of license plate recognition will show as below:</p> 

[Snapshot File Name]

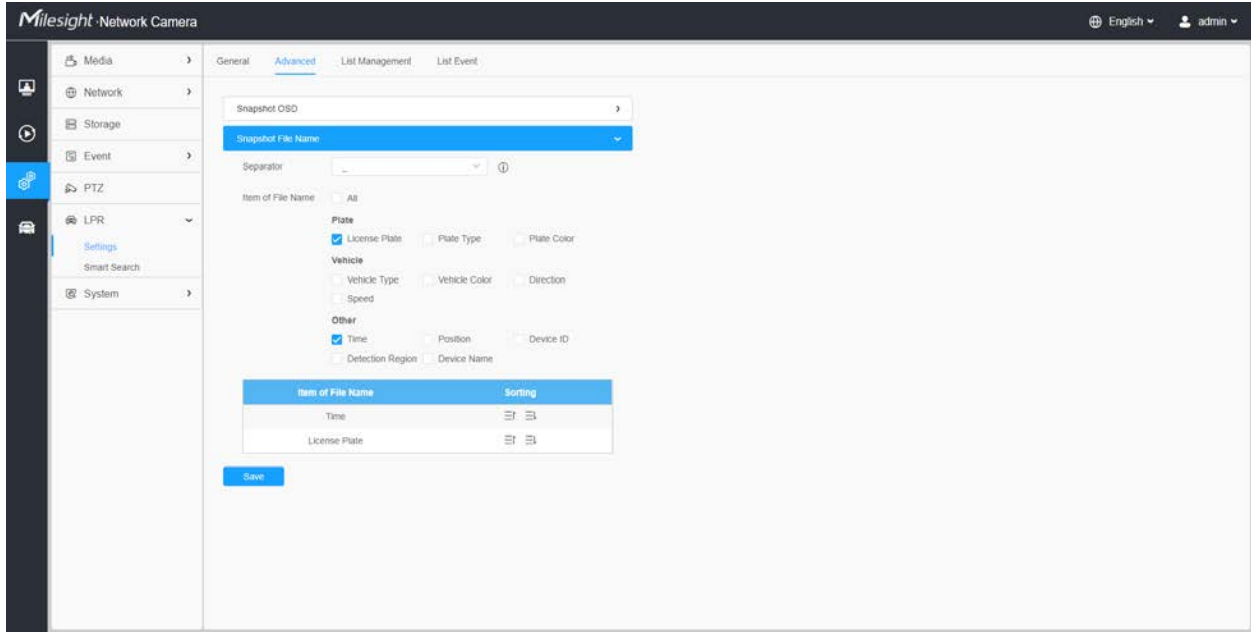



Table 55. Description of the buttons

Parameters	Function Introduction
<p>Separator</p>	<p>“-”, “_” and Space are available for File Name Separator format. The default separator is “-”.</p>
<p>Item of File Name</p>	<p>You can customize the snapshot file name according to items chosen.</p> <div data-bbox="618 1230 1414 1619" style="border: 1px solid #ccc; padding: 10px; background-color: #f9f9f9;"> <p>Item of File Name <input type="checkbox"/> All</p> <p>Plate</p> <p><input checked="" type="checkbox"/> License Plate <input type="checkbox"/> Plate Type <input type="checkbox"/> Plate Color</p> <p>Vehicle</p> <p><input type="checkbox"/> Vehicle Type <input type="checkbox"/> Vehicle Color <input type="checkbox"/> Direction</p> <p><input type="checkbox"/> Speed</p> <p>Other</p> <p><input checked="" type="checkbox"/> Time <input type="checkbox"/> Position <input type="checkbox"/> Device ID</p> <p><input type="checkbox"/> Detection Region <input type="checkbox"/> Device Name</p> </div>

Each time when an item is checked, the list will add the item row, including the item name and sorting operation. You can click  and  button to sort these items, and choose separator to connect these items name. Also, the content of Position and Device ID items can be customized. When you check all items, the function interface will show as below:

Item of File Name All

Plate

License Plate Plate Type Plate Color

Vehicle

Vehicle Type Vehicle Color Direction

Speed

Other

Time Position Device ID

Detection Region Device Name

Item of File Name	Sorting
Time	⇅ ⇅
License Plate	⇅ ⇅
Plate Type	⇅ ⇅
Speed	⇅ ⇅
Direction	⇅ ⇅
Detection Region	⇅ ⇅
Position: <input type="text" value="Position"/>	⇅ ⇅
Device Name	⇅ ⇅
Device ID: <input type="text" value="Device ID"/>	⇅ ⇅
Plate Color	⇅ ⇅
Vehicle Type	⇅ ⇅
Vehicle Color	⇅ ⇅

 **Note:** You need to check at least one item.

For example, you can choose items, separator and items sorting as below:

Item of File Name All

Plate

License Plate Plate Type Plate Color

Vehicle

Vehicle Type Vehicle Color Direction

Speed

Other

Time Position Device ID

Detection Region Device Name

Item of File Name	Sorting
Time	⇅ ⇅
License Plate	⇅ ⇅

Once license plate is recognized, and the snapshot will be uploaded via FTP or Email or stored on your local LPR Picture File Path. Then, You can see the snapshot file name which you customize as shown below:

Full-snapshot Recognized successfully



Full-snapshot Recognized failed



420201116021729_RT528N

License plate snapshot Recognized successfully



20201116021729_RT528N

License plate snapshot Recognized failed



20201116021729_##528N

Note:

- If the item checked is not recognized successfully, then the item will be displayed with the specific symbol “#”.
- The file name of full-snapshot will be preceded by a number of 4.

List Management

Add the license plates to this interface as Black or White type (Black/White List), and then you can set the alarm action for these license plates in the corresponding black list mode or white list mode interface. When these license plates are detected, the camera will respond according to your settings.

When adding the license plates, you can also define the ID card number for the license plate, when the camera identifies these license plates and recognizes the attached ID card number, it will send the ID card number to your parking system through the **Wiegand protocol**, and then your system can respond based on the received information, such as access control.

 **Note:** Please make sure you have correctly connected the Wiegand interface to the camera and enabled it, for more information please refer to: [Wiegand \(page 287\)](#).

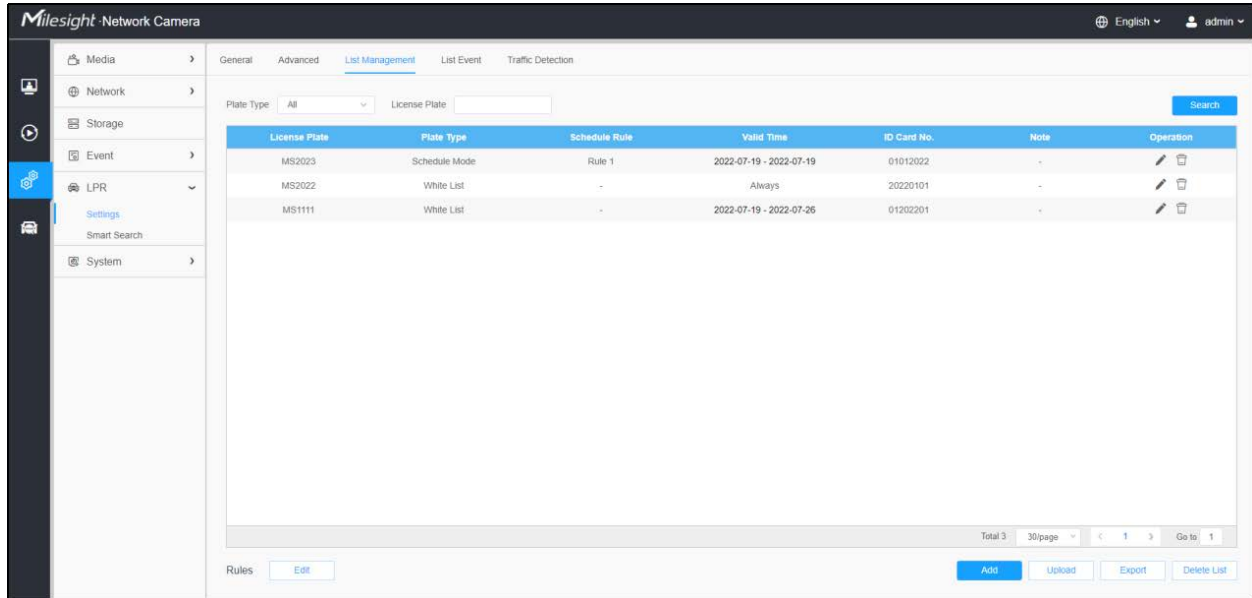











License Plate	Plate Type	Schedule Rule	Valid Time	ID Card No.	Note	Operation
MS2023	Schedule Mode	Rule 1	2022-07-19 - 2022-07-19	01012022	-	 
MS2022	White List	-	Always	20220101	-	 
MS1111	White List	-	2022-07-19 - 2022-07-26	01202201	-	 

Table 56. Description of the buttons

Parameters	Function Introduction
<p>Add License Plate</p>	<p>Select the license plate type as black or white, enter the ID Card number and license plate, click the “Add” button, the license plate will be added successfully.</p> 
<p>Batch Upload</p>	<p>You can add a csv form with the license plate you want to add, click the "Browse" button to import the form to this interface, click the "Upload" button, the license plates will be added successfully.</p> <p> Note: You can first download the template as a reference in this interface.</p>
<p>List Search</p>	<p>Select Plate Type or directly enter the license plate number, click the “Search” button, the corresponding license plate will be displayed in the list below.</p>
<p>Export List</p>	<p>Click the "Export List" button to export the license plate in the current list to a csv form locally.</p>
<p>Delete List</p>	<p>Click the "Delete List" button to delete all the license plate in the current list.</p>

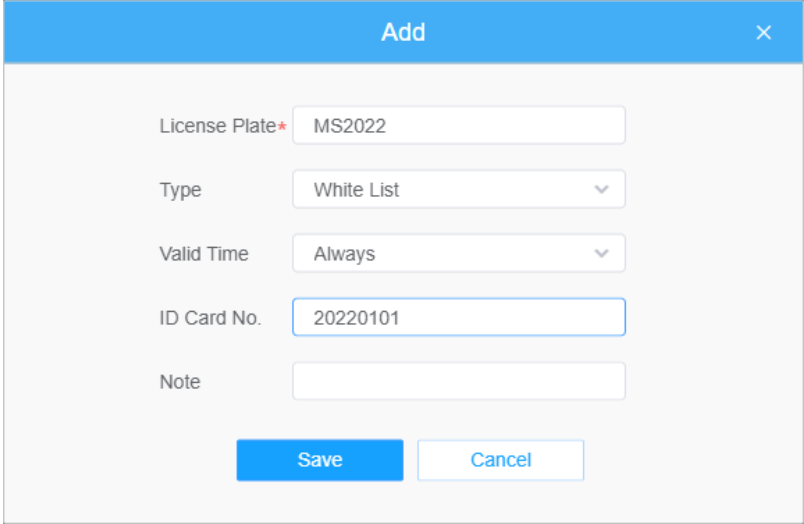
Parameters	Function Introduction
<p style="text-align: center;">Schedule Rules</p>	<p>Click the "Edit" button to customize a rule.</p>  <p>And then set the license plate to Schedule Mode and choose a custom schedule rule that can configure the license plate as Black List or White List at different times.</p>  <p> Note: Support setting up to 4 Schedule Rules for Schedule Mode.</p>

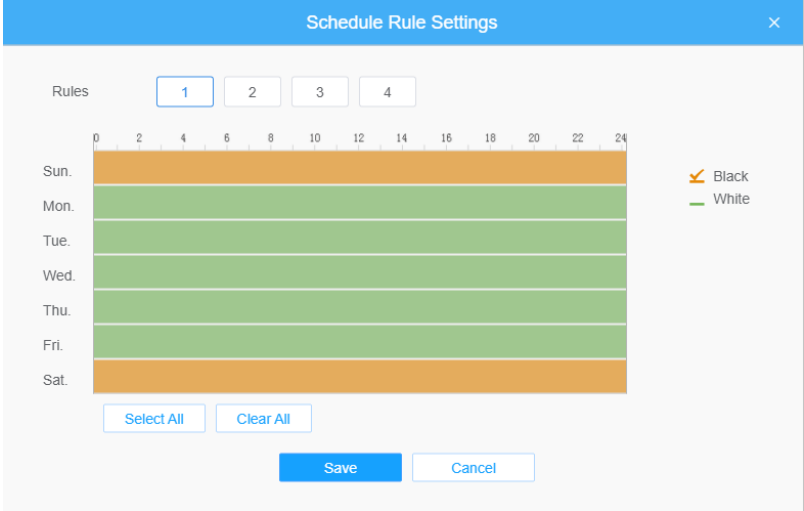
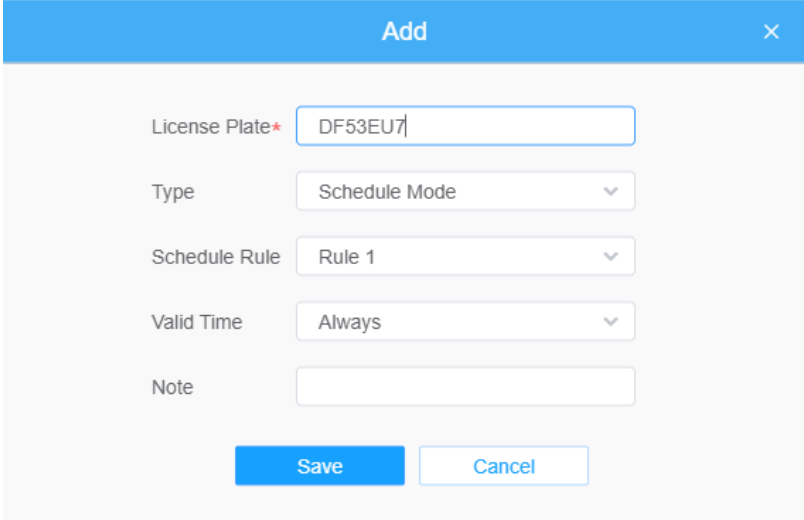
 **Note:** It supports adding 1000 Black List and White List.

List Event

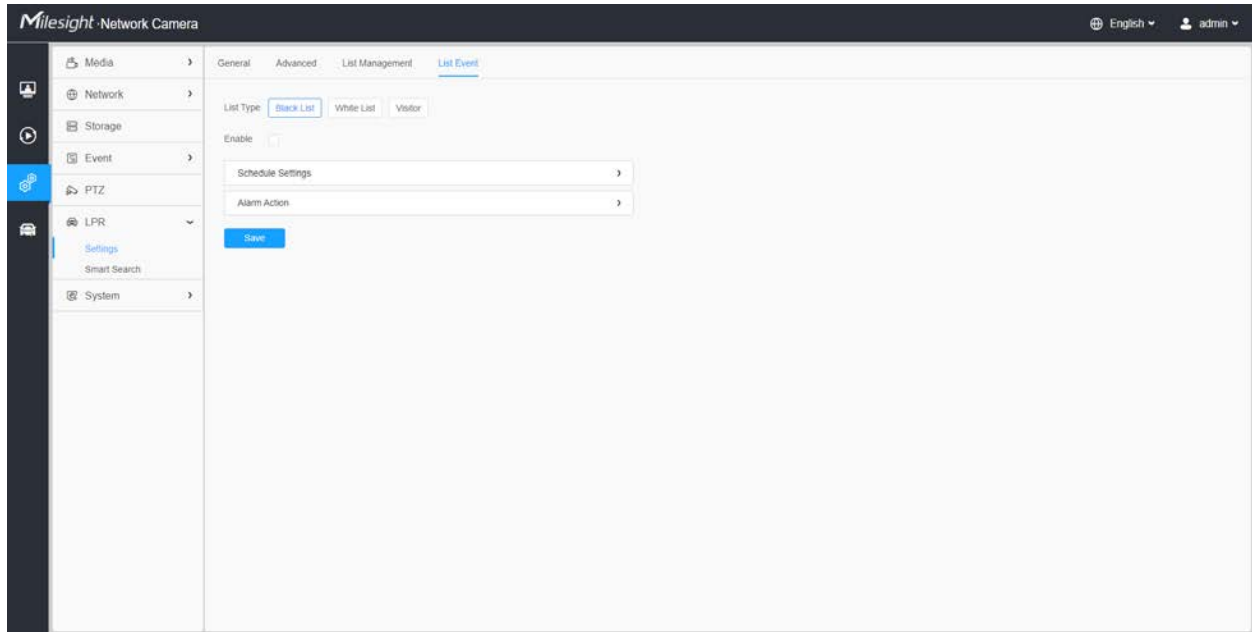

Step1: Select the List Type. Check the check box to enable Black List/White List/Visitor mode.

Step2: The corresponding alarm icon is triggered when the Black List/White List/Visitor vehicles passing by.

Black List:

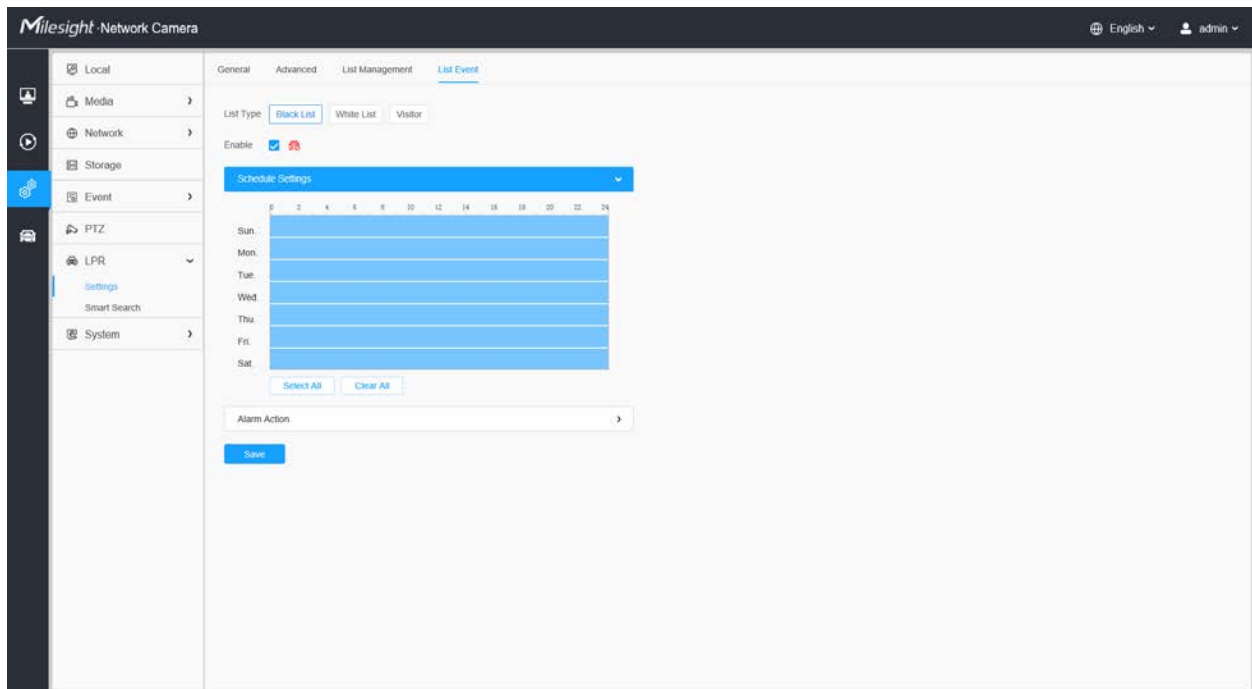

Recognition Result

Plate Type: **Black List** Plate Color: White Vehicle Type: Car
 Vehicle Color: Black Speed: - Direction: Away

No.	License Plate	Snapshot	Plate Type	Plate Color	Vehicle Type	Vehicle Color	Speed	Direction	Detection Region	Time	Operation
14	DOK69		Black List	White	Car	Black	-	Away	1	2022-04-21 23:25:42	
13	BOJY11		Visitor	White	Car	Black	-	Away	1	2022-04-21 23:25:39	
12	ZBKZ2		Visitor	White	Car	Red	-	Away	2	2022-04-21 23:25:23	
11	MGB82		Visitor	White	Bus	Blue	-	Away	2	2022-04-21 23:25:21	
10	DCCG1		Visitor	White	Car	White	-	Away	2	2022-04-21 23:25:19	
9	FEJ01		Visitor	White	Car	Black	-	Away	3	2022-04-21 23:25:17	
8	DOJ02		Visitor	White	Car	Gray	-	Away	2	2022-04-21 23:25:14	
7	WHV00		Visitor	White	Car	Gray	-	Away	2	2022-04-21 23:25:10	
6	PHW41		White List	White	Minibus	Red	-	Away	0	2022-04-21 21:35:04	

White List:

Local Media Network Storage Event PTZ LPR Settings Smart Search System

General Advanced List Management List Event

List Type: Black List White List Visitor

Enable:

Schedule Settings

	0	2	4	6	8	10	12	14	16	18	20	22	24
Sun.	<input checked="" type="checkbox"/>	<input checked="" type="checkbox"/>	<input checked="" type="checkbox"/>	<input checked="" type="checkbox"/>	<input checked="" type="checkbox"/>	<input checked="" type="checkbox"/>	<input checked="" type="checkbox"/>	<input checked="" type="checkbox"/>	<input checked="" type="checkbox"/>	<input checked="" type="checkbox"/>	<input checked="" type="checkbox"/>	<input checked="" type="checkbox"/>	<input checked="" type="checkbox"/>
Mon.	<input checked="" type="checkbox"/>	<input checked="" type="checkbox"/>	<input checked="" type="checkbox"/>	<input checked="" type="checkbox"/>	<input checked="" type="checkbox"/>	<input checked="" type="checkbox"/>	<input checked="" type="checkbox"/>	<input checked="" type="checkbox"/>	<input checked="" type="checkbox"/>	<input checked="" type="checkbox"/>	<input checked="" type="checkbox"/>	<input checked="" type="checkbox"/>	<input checked="" type="checkbox"/>
Tue.	<input checked="" type="checkbox"/>	<input checked="" type="checkbox"/>	<input checked="" type="checkbox"/>	<input checked="" type="checkbox"/>	<input checked="" type="checkbox"/>	<input checked="" type="checkbox"/>	<input checked="" type="checkbox"/>	<input checked="" type="checkbox"/>	<input checked="" type="checkbox"/>	<input checked="" type="checkbox"/>	<input checked="" type="checkbox"/>	<input checked="" type="checkbox"/>	<input checked="" type="checkbox"/>
Wed.	<input checked="" type="checkbox"/>	<input checked="" type="checkbox"/>	<input checked="" type="checkbox"/>	<input checked="" type="checkbox"/>	<input checked="" type="checkbox"/>	<input checked="" type="checkbox"/>	<input checked="" type="checkbox"/>	<input checked="" type="checkbox"/>	<input checked="" type="checkbox"/>	<input checked="" type="checkbox"/>	<input checked="" type="checkbox"/>	<input checked="" type="checkbox"/>	<input checked="" type="checkbox"/>
Thu.	<input checked="" type="checkbox"/>	<input checked="" type="checkbox"/>	<input checked="" type="checkbox"/>	<input checked="" type="checkbox"/>	<input checked="" type="checkbox"/>	<input checked="" type="checkbox"/>	<input checked="" type="checkbox"/>	<input checked="" type="checkbox"/>	<input checked="" type="checkbox"/>	<input checked="" type="checkbox"/>	<input checked="" type="checkbox"/>	<input checked="" type="checkbox"/>	<input checked="" type="checkbox"/>
Fri.	<input checked="" type="checkbox"/>	<input checked="" type="checkbox"/>	<input checked="" type="checkbox"/>	<input checked="" type="checkbox"/>	<input checked="" type="checkbox"/>	<input checked="" type="checkbox"/>	<input checked="" type="checkbox"/>	<input checked="" type="checkbox"/>	<input checked="" type="checkbox"/>	<input checked="" type="checkbox"/>	<input checked="" type="checkbox"/>	<input checked="" type="checkbox"/>	<input checked="" type="checkbox"/>
Sat.	<input checked="" type="checkbox"/>	<input checked="" type="checkbox"/>	<input checked="" type="checkbox"/>	<input checked="" type="checkbox"/>	<input checked="" type="checkbox"/>	<input checked="" type="checkbox"/>	<input checked="" type="checkbox"/>	<input checked="" type="checkbox"/>	<input checked="" type="checkbox"/>	<input checked="" type="checkbox"/>	<input checked="" type="checkbox"/>	<input checked="" type="checkbox"/>	<input checked="" type="checkbox"/>

Alarm Action: None

Save

Recognition Result

Plate Type: **White List** Plate Color: White Vehicle Type: Minibus
 Vehicle Color: Red Speed: - Direction: Away

No.	License Plate	Snapshot	Plate Type	Plate Color	Vehicle Type	Vehicle Color	Speed	Direction	Detection Region	Time	Operation
15	DOH1		White List	White	Minibus	Red	-	Away	2	2022-04-21 23:25:45	
14	DKK8		Black List	White	Car	Black	-	Away	1	2022-04-21 23:25:42	
13	BOV1		Visitor	White	Car	Black	-	Away	1	2022-04-21 23:25:39	
12	ZBKZ		Visitor	White	Car	Red	-	Away	2	2022-04-21 23:25:23	
11	MGBB		Visitor	White	Bus	Blue	-	Away	2	2022-04-21 23:25:21	
10	DOCG		Visitor	White	Car	White	-	Away	3	2022-04-21 23:25:19	
9	FE3Q		Visitor	White	Car	Black	-	Away	2	2022-04-21 23:25:17	
8	DOJC		Visitor	White	Car	Gray	-	Away	2	2022-04-21 23:25:14	
7	WALURP		Visitor	White	Car	Gray	-	Away	9	2022-04-21 21:25:10	

Visitor:

Local Media Network Storage Event PTZ LPR Settings Smart Search System

General Advanced List Management List Event

List Type: Black List White List **Visitor**

Enable

Schedule Settings

	0	2	4	6	8	10	12	14	16	18	20	22	24
Sun.													
Mon.													
Tue.													
Wed.													
Thu.													
Fri.													
Sat.													

Select All Clear All

Alarm Action: None

Save

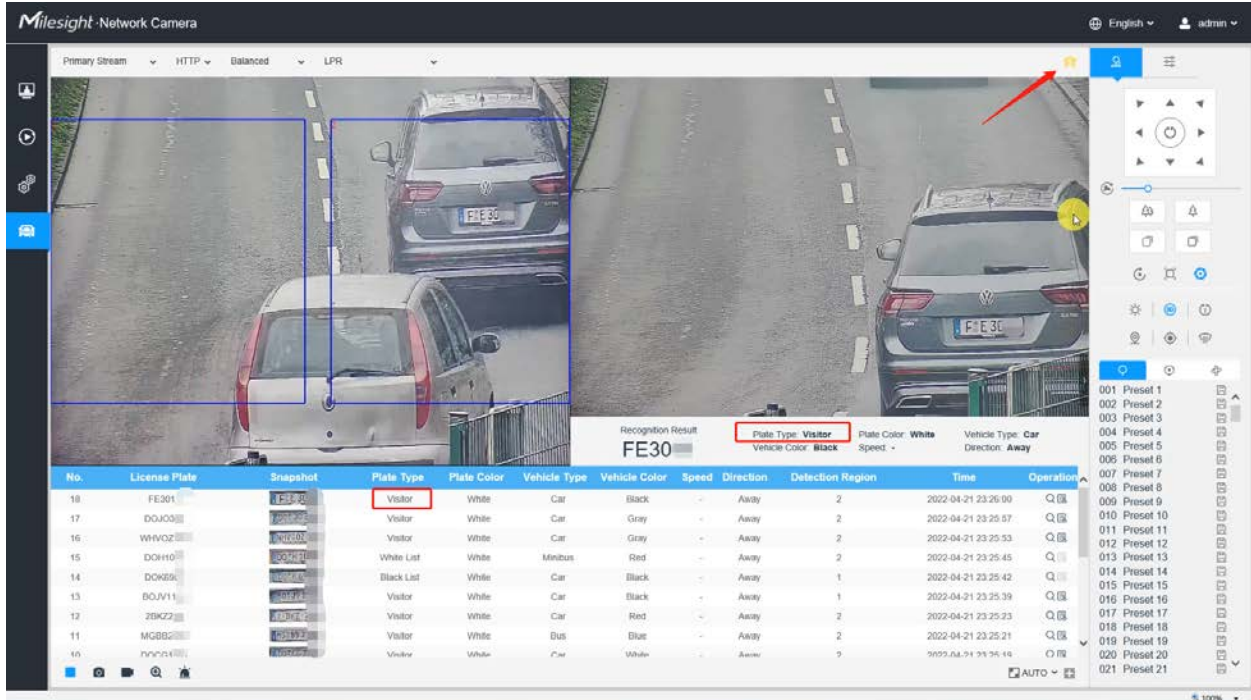

[Schedule Settings]

Step3: Schedule Settings.

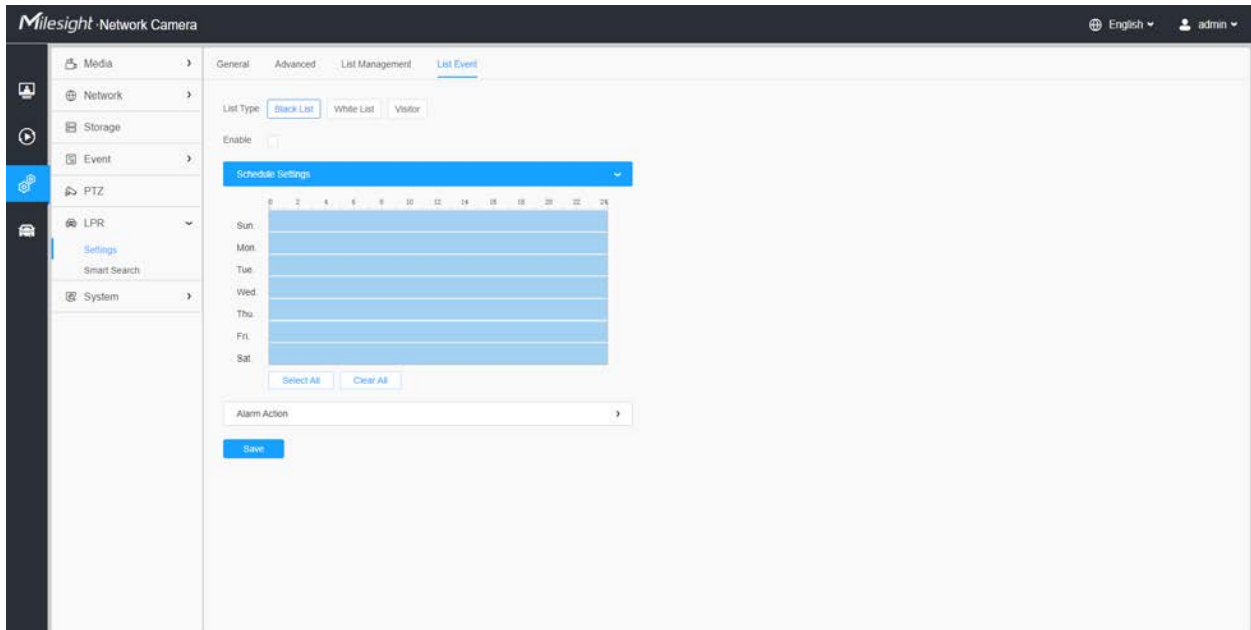
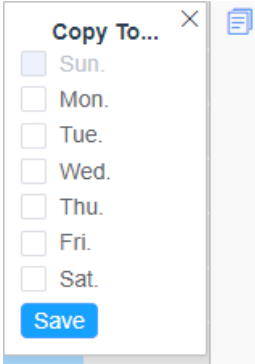
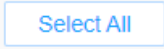
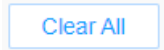

Table 57. Description of the buttons

Parameters	Function Introduction
	<p>Copy the schedule area to another date.</p>
	<p>Select all schedule.</p>
	<p>Clear all schedule.</p>

[Alarm Action]

Step4: Set Alarm Action.

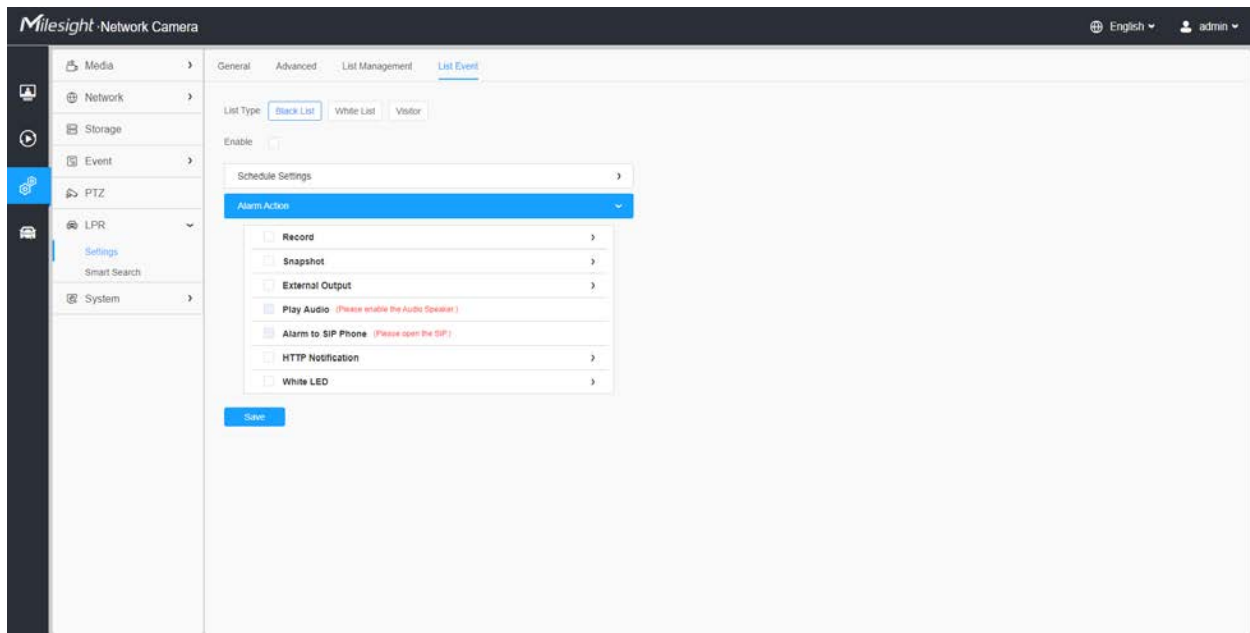

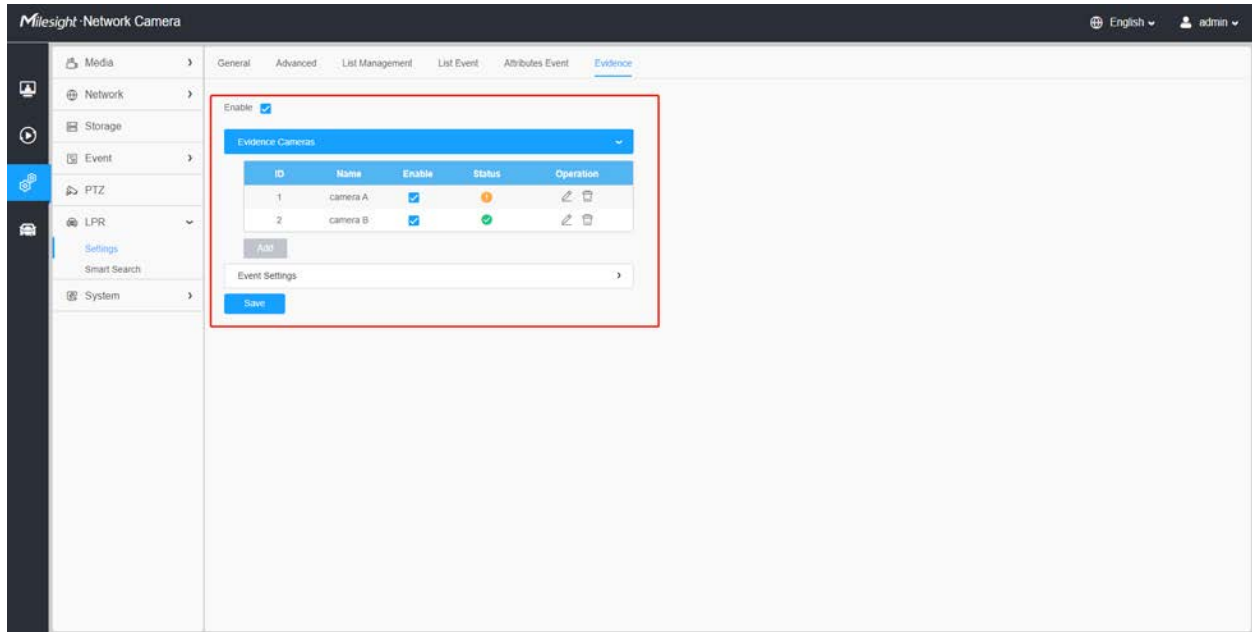

Table 58. Description of the buttons

Parameters	Function Introduction
Record	<p>Duration: Selected the duration time of alarm. 5s/10s/15s/20s/25s/30s are available.</p> <p>Linkage: Save alarm recording files into SD Card or NAS or Upload the recording files via FTP.</p>
Snapshot	<p>Number: The number of snapshot, 1~5 are available.</p> <p>Interval: This cannot be edited unless you choose more than 1 to Snapshot.</p> <p>Linkage: Save alarm recording files into SD Card or NAS, Upload the recording files via FTP and send alarm email.</p>
External Output	If the camera equips with External Output, you can enable the action after configuring the trigger duration.
Play Audio	<p>Auto/10 seconds/30 seconds/1 minute/5 minutes/10 minutes are available.</p> <p> Note: Please enable the Audio Speaker.</p>
Alarm to SIP Phone	Support to call the SIP phone after enable the SIP function.
HTTP Notification	<p>Support to pop up the alarm news to specified HTTP URL.</p> <p> Note:</p> <ul style="list-style-type: none"> • Three HTTP notifications at most can be added to the same event. • HTTP Notification supports Basic & Digest authentication
White LED	When the alarm triggered, White LED will turn on to warning the detected objects (Only for PTZ Bullet).

Evidence

This function can bind other cameras as evidence cameras to assist in capturing the entire monitoring scene of the LPR camera to facilitate forensics and help law enforcement.



Settings steps are shown as follows:

Step1: Check the checkbox to enable this function.

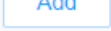
Step2: Click  button to add the evidence camera by entering the user name, password, and Address. And the camera name of the evidence camera can be customized.

 **Note:**

- Up to 2 evidence cameras can be added.
- Evidence camera captures primary stream picture by default.
- For the Address, input evidence camera IP directly for Mlesight camera, and snapshot URL is supported for third-party camera.



Step3: The added evidence cameras will be listed in the interface, and users can edit these cameras separately.

ID	Name	Enable	Status	Operation
1	camera A	<input checked="" type="checkbox"/>	✔	
2	camera B	<input checked="" type="checkbox"/>	✔	

For the meaning of the buttons on the interface, please refer to the following table.

Table 59.

Parameters	Function Introduction
	Enable or disable the evidence camera.
	Check the connection status of the evidence camera. : Connect : Disconnect

Parameters	Function Introduction
	Edit the evidence camera.
	Delete the evidence camera.

Step4: Set Capture Conditions. Currently it only supports the always option, which means that as long as the camera recognizes the license plate, the evidence camera will be triggered to capture a picture of the entire scene.

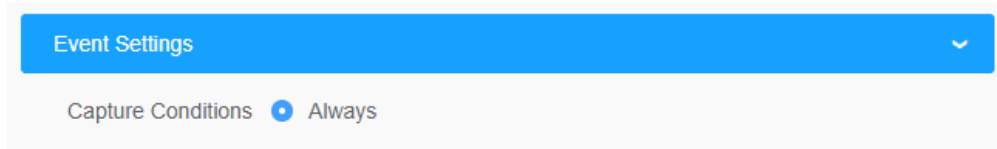

Step5: After completing the above settings, the evidence camera will work together to capture the scene when the LPR camera captures the license plate, which can be viewed on the Live View interface of LPR Mode.

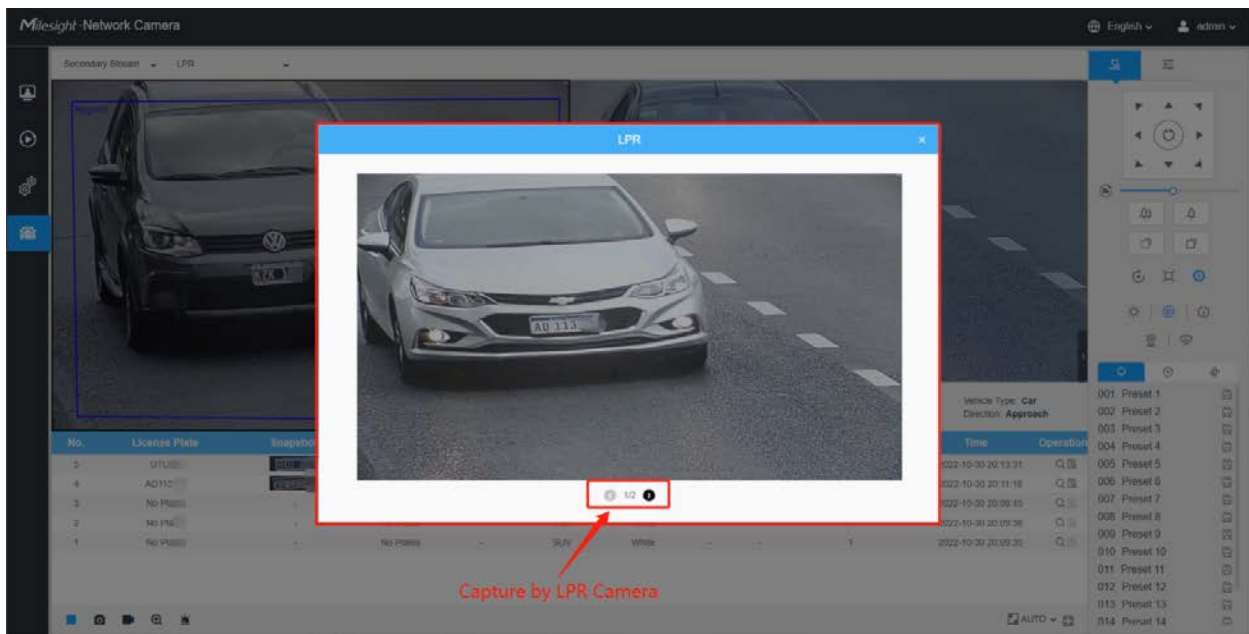

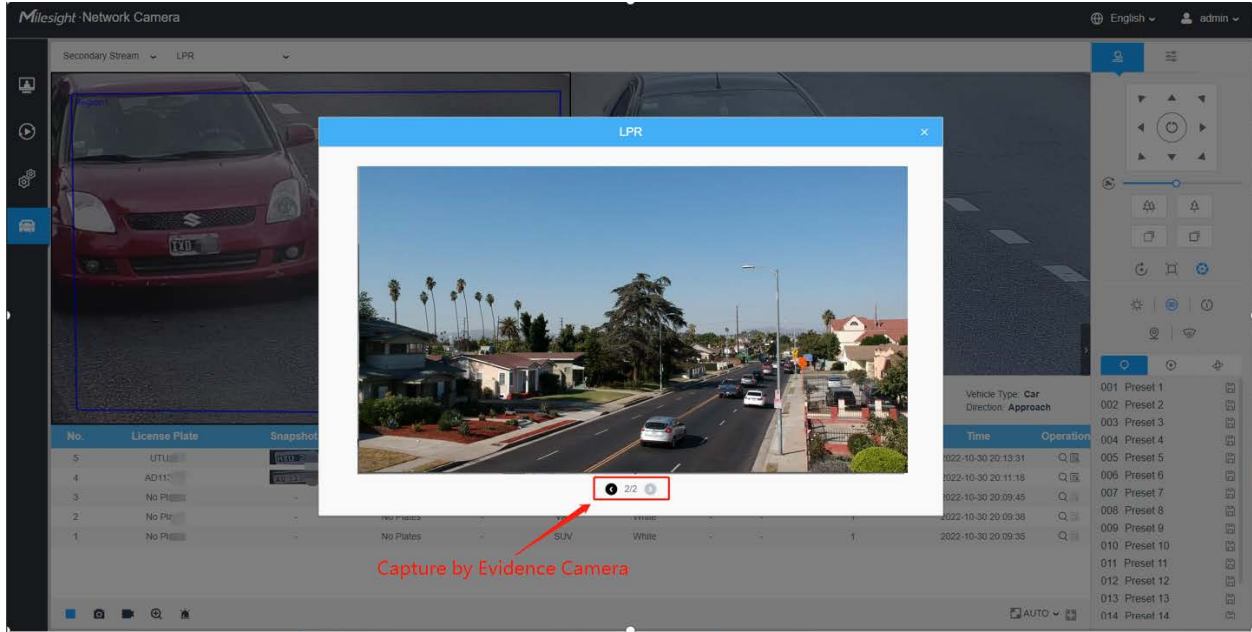

Users can also search and export the image captured by evidence camera in the Smart Search interface.

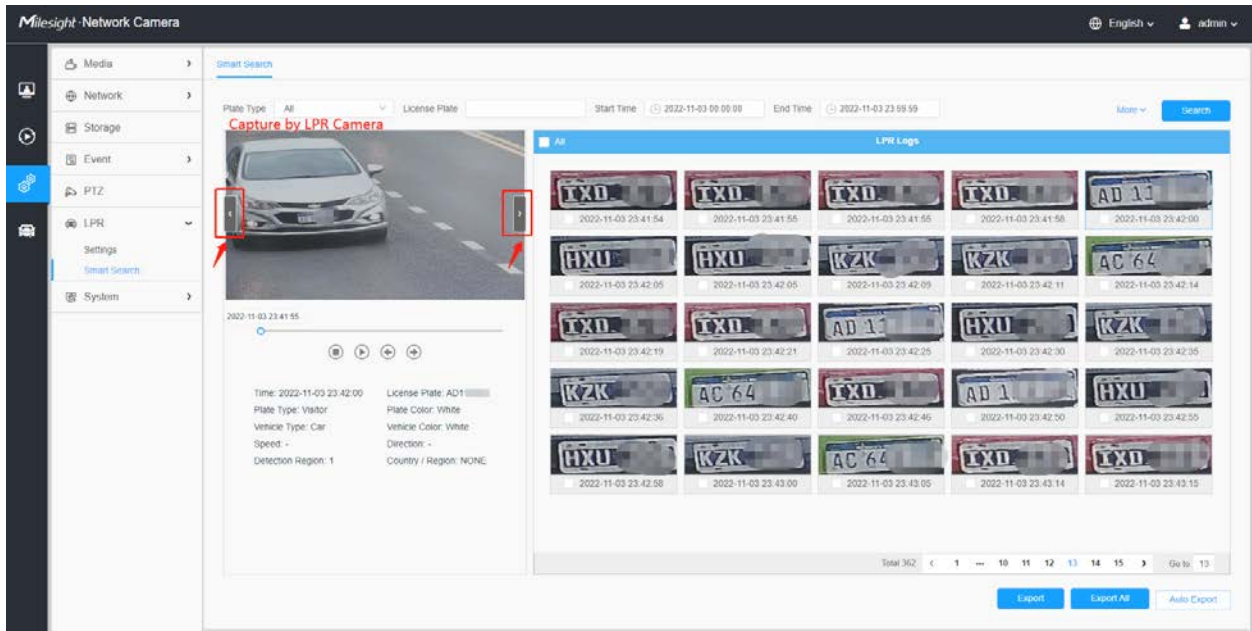

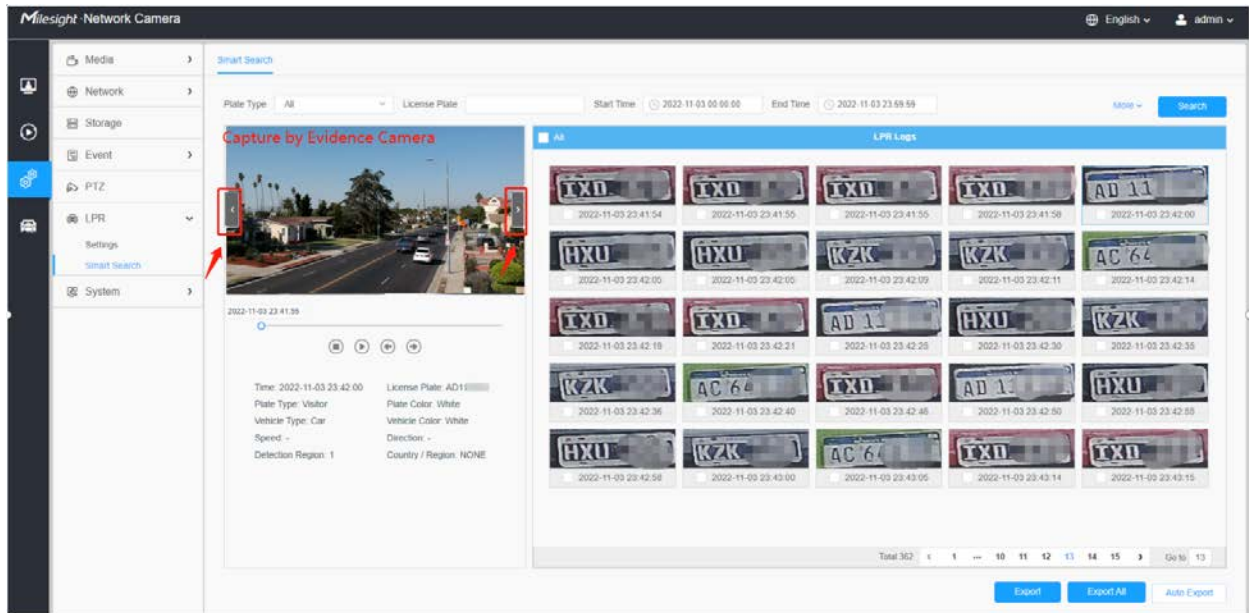

Smart Search

The real-time detection results will be displayed on the right side of Smart Search page, including detected time, live screenshot, license plate and vehicle attributes.

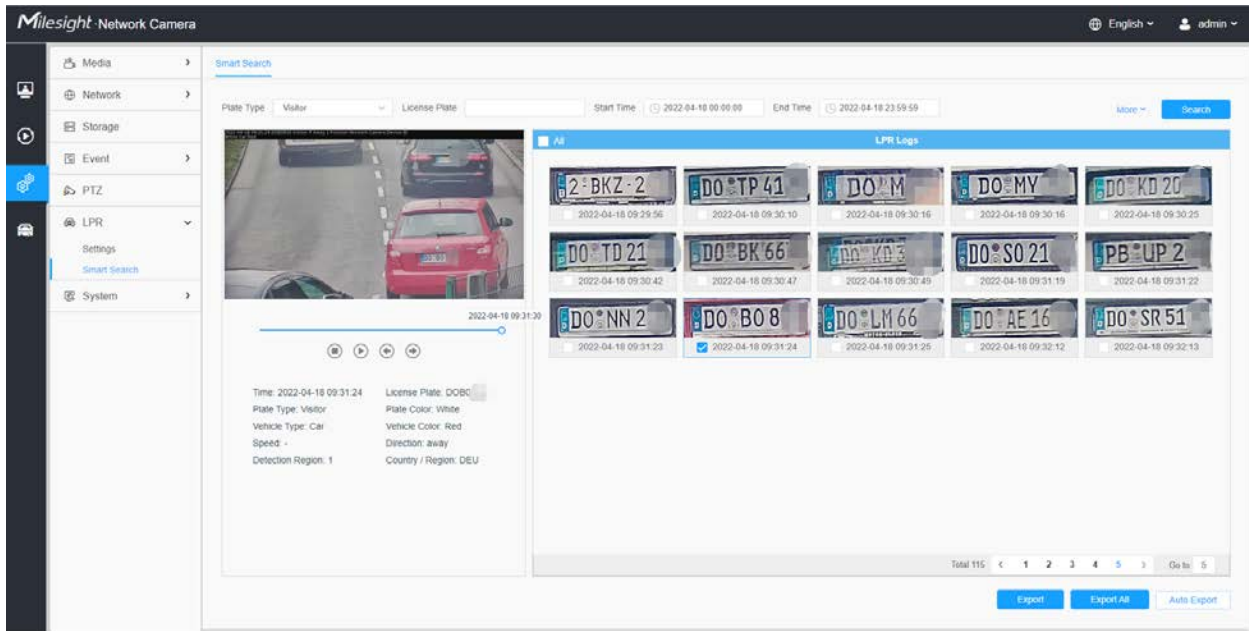

Step1: Select Plate Type and Vehicle Attributes or directly enter the license plate number and then select Start Time and End Time. The related license plate information will be displayed as below by one click on the “**Search**” button.

 **Note:**

- It supports displaying 4,000 logs.
- Only when there is a SD Card or NAS has been set on the storage management , then the logs can be stored and showed on Smart Search page.

Step2: Click on the thumbnail photo under the LPR Logs, then the license plate details will be shown as below :

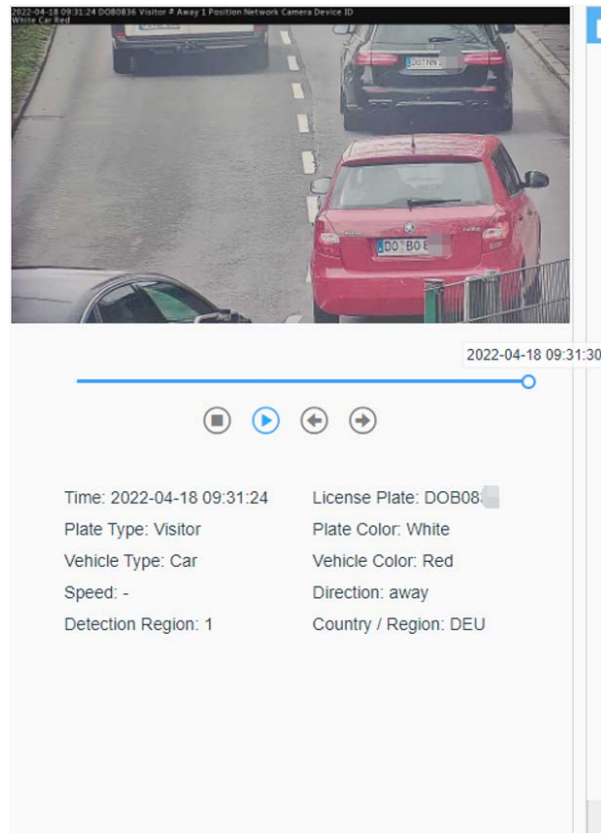

Note: If the evidence feature is enabled, you can also click the arrow button on the snapshot to check the image captured by the evidence camera.

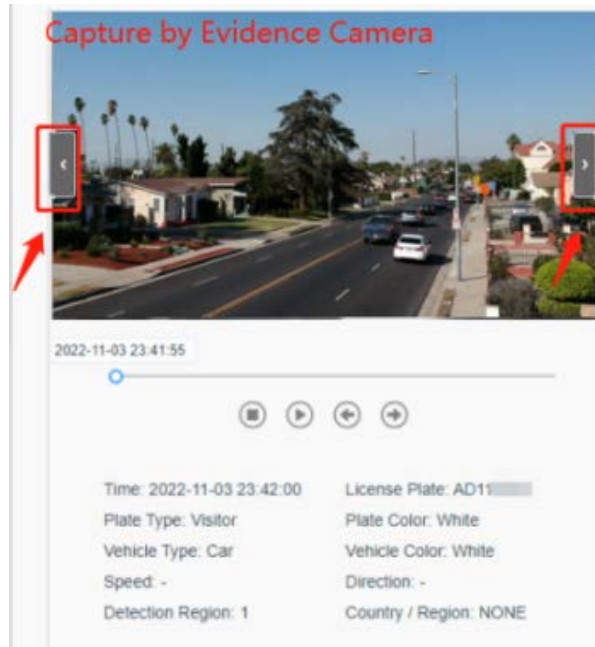

Step3: Click the "Export" or "Export All" button to export the desired files in the current list to a local folder.

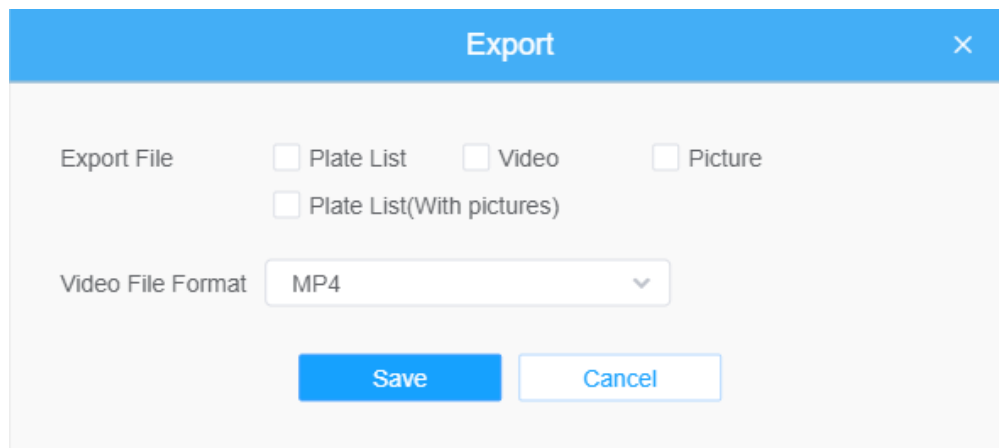

Step4: Click the "Auto Export" button to automatically export the logs to FTP, Email or Storage.

Auto Export ×

Enable

Day

Time

Export Time Range

Export to FTP Email Storage

2.6.6 System

System Setting

Here you can check System information and Date&Time.

System info

All information about the hardware and software of the camera can be checked on this page.

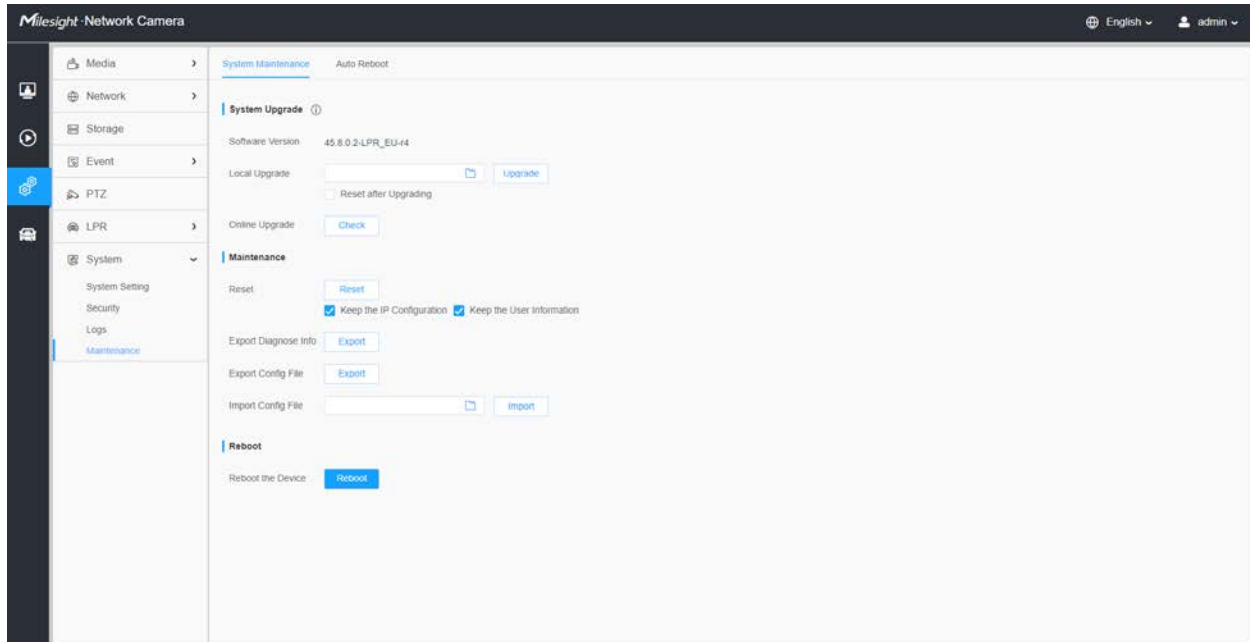

Table 60. Description of the buttons

Parameters	Function Introduction
Device Name	The device name can be customized.
Product Model	The product model of the camera.
Hardware Version	The hardware version of the camera.
Software Version	The software version of the camera can be upgraded.
LPR License (Only for LPR2, LPR3, LPR 4, LPR EU, LPR AP and LPR AM)	Generated by camera's information. Note: Only for LPR Series.
License Status (Only for LPR2, LPR3, LPR 4, LPR EU, LPR AP and LPR AM)	Show present license status, including Valid and Invalid Note: Only for LPR Series.
MAC Address	Media Access Control address.
S/N	Stock Number.
Device Information	The device information, including information about alarm I/O and clipper chip.
Alarm Input	The number of Alarm Input interface. Note: The Alarm Input will appear only when the camera have alarm input/output interface.

Parameters	Function Introduction
Alarm Output	The number of Alarm Output interface. Note: The Alarm Output will appear only when the camera have alarm input/output interface.
Uptime	The elapsed time since the last restarted of the device.
Save	Save the configuration.

Date&Time

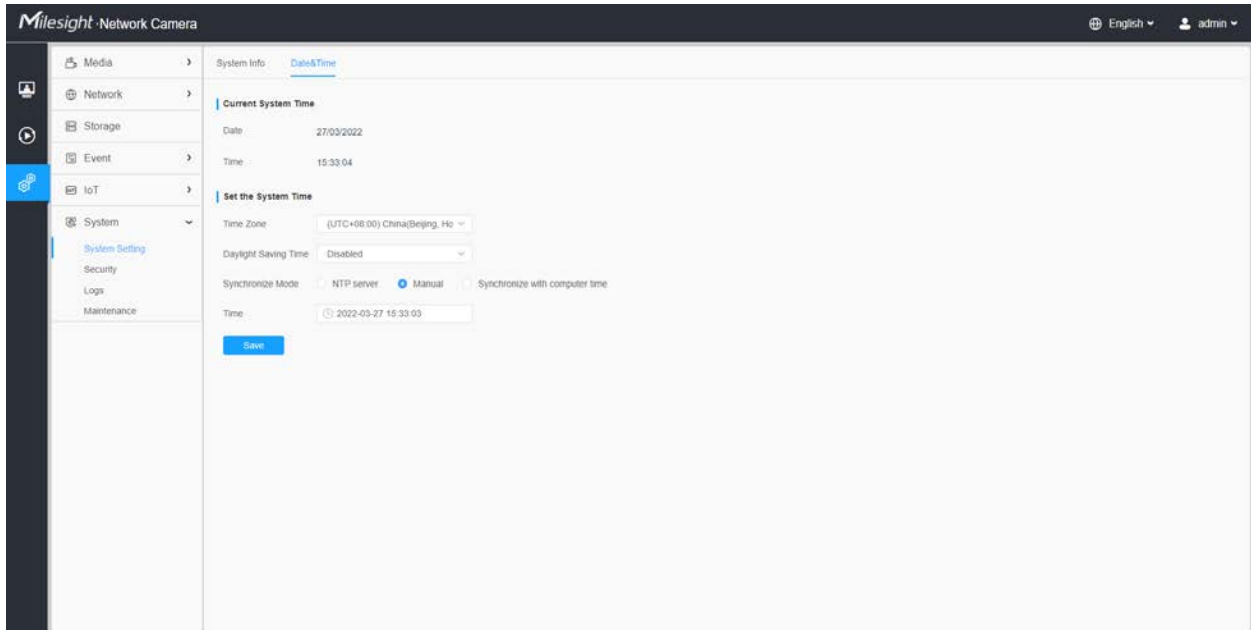

Table 61. Description of the buttons

Parameters	Function Introduction
Current System Time	Current date&time of the system.
Set the System Time	Time Zone: Choose a time zone for your location.
	Daylight Saving time: Enable the daylight saving time.

Parameters	Function Introduction
	<p>Synchronize Mode: NTP server, Manual and Synchronize with computer time are optional.</p> <p>NTP server: Input the address of NTP server.</p> <p>NTP Sync: Regularly update your time according to the interval time.</p> <p>Manual: Set the system time manually.</p> <p>Synchronize with computer time: Synchronize the time with your computer.</p>
<p style="text-align: center;">Save</p>	<p>Save the configuration.</p>

Security

Here you can configure User, Access List, Security Service, Watermark, etc.

User

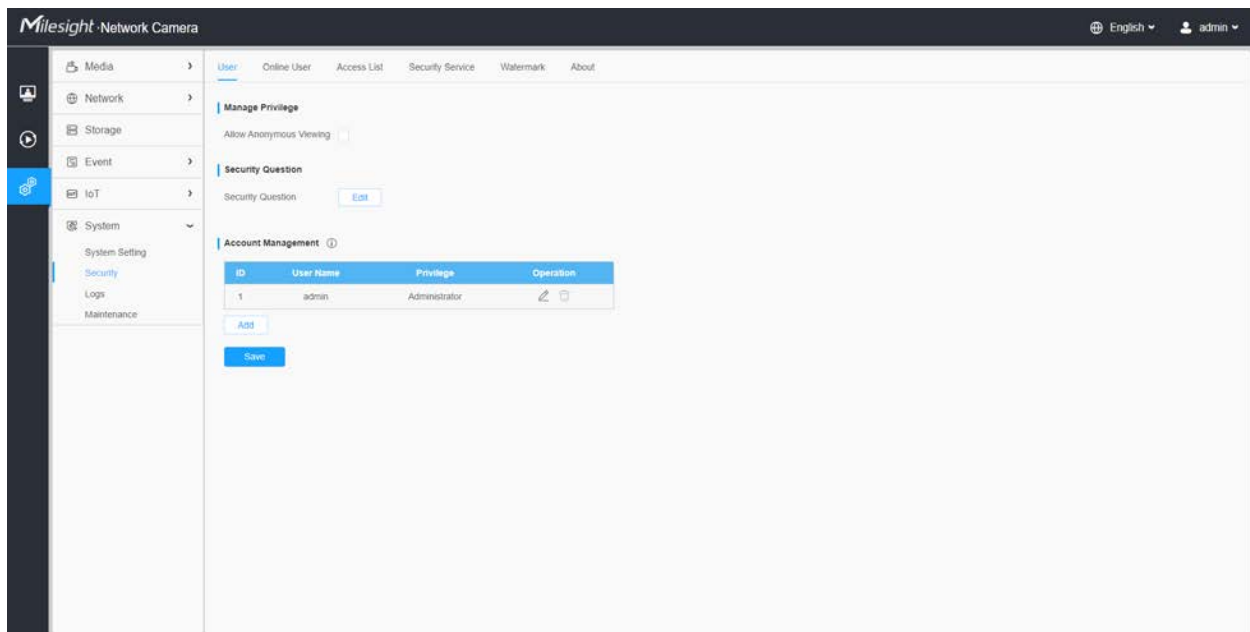



Table 62. Description of the buttons

Parameters	Function Introduction
<p>Manage Privilege</p>	<p>Allow anonymous viewing: Check the checkbox to enable visit from whom doesn't have account of the device.</p>

Parameters	Function Introduction
<p>Security Question</p>	<p>Click "Edit" button to set three security questions for your camera. In case that you forget the password, you can click "Forget Password" button on login page to reset the password by answering three security questions correctly.</p> <div data-bbox="532 411 1330 1058" style="border: 1px solid #ccc; padding: 10px; background-color: #f9f9f9;"> <div style="background-color: #0070c0; color: white; padding: 5px; display: flex; justify-content: space-between; align-items: center;"> Security Question Settings × </div> <div style="margin-top: 10px;"> <p>Admin Password* <input type="password"/></p> <p>Security Question1 <input type="text" value="What's your father's name?"/></p> <p>Answer1* <input type="text"/></p> <p>Security Question2 <input type="text" value="What's your father's name?"/></p> <p>Answer2* <input type="text"/></p> <p>Security Question3 <input type="text" value="What's your father's name?"/></p> <p>Answer3* <input type="text"/></p> <div style="display: flex; justify-content: center; gap: 20px; margin-top: 10px;"> Save Cancel </div> </div> </div> <p>There are twelve default questions below, you can also customize the security questions.</p> <div data-bbox="532 1171 1330 1619" style="border: 1px solid #ccc; padding: 10px; background-color: #f9f9f9;"> <div style="border-bottom: 1px solid #ccc; padding-bottom: 5px; display: flex; justify-content: space-between; align-items: center;"> What's your father's name? ^ </div> <div style="display: flex; justify-content: space-between;"> <div style="width: 45%;"> <ul style="list-style-type: none"> <li style="background-color: #0070c0; color: white; padding: 5px; margin-bottom: 5px;">What's your father's name? <li style="padding: 5px; margin-bottom: 5px;">What's your favorite sport? <li style="padding: 5px; margin-bottom: 5px;">What's your mother's name? <li style="padding: 5px; margin-bottom: 5px;">What's your mobile number? <li style="padding: 5px; margin-bottom: 5px;">What's your first pet's name? <li style="padding: 5px; margin-bottom: 5px;">What's your favorite book? <li style="padding: 5px; margin-bottom: 5px;">What's your favorite game? </div> <div style="width: 45%;"> <ul style="list-style-type: none"> <li style="padding: 5px; margin-bottom: 5px;">What's your favorite food? <li style="padding: 5px; margin-bottom: 5px;">What's your lucky number? <li style="padding: 5px; margin-bottom: 5px;">What's your favorite color? <li style="background-color: #e0e0e0; padding: 5px; margin-bottom: 5px;">What's your best friend's name? <li style="padding: 5px; margin-bottom: 5px;">Where did you go on your first trip? <li style="padding: 5px; margin-bottom: 5px;">Customized Question </div> </div> </div>

Parameters	Function Introduction
<p style="text-align: center;">Account Management</p>	<p>Click “Add” button, it will display Account Management page. You can add an account to the camera by entering Admin Password, User Level, User Name, New Password, Confirm, and edit user privilege by clicking . The added account will be displayed in the account list.</p> <p>Admin Password: You can add an account only after you enter the correct admin password.</p> <p>User Level: Set the privilege for the account.</p> <p>User Name: Input user name for creating an account.</p> <p>New Password: Input password for the account.</p> <p>Confirm: Confirm the password.</p> <p>You can edit and delete the account in the account list under the admin account. For the default admin account, you can only change the password, and it cannot be deleted.</p> <p> Note:</p> <ul style="list-style-type: none"> • Support up to 20 users, including a default user and 19 custom added users. • The operator privilege is all checked by default.

Online User

Here real-time status of user logging in camera will be shown.

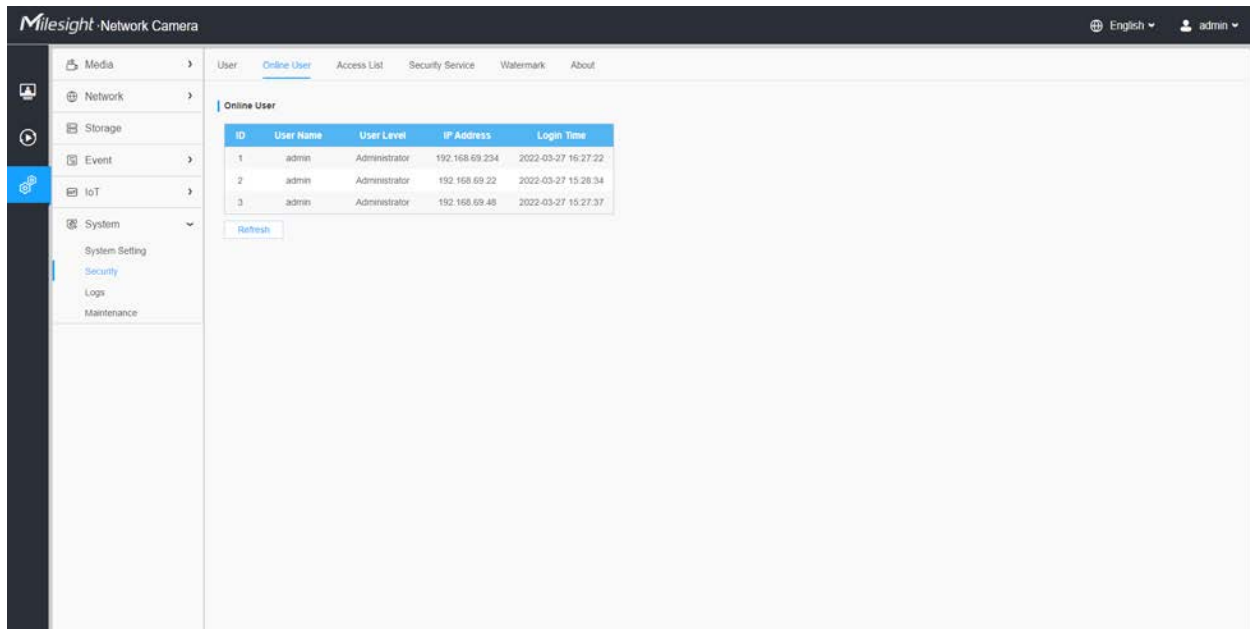



Table 63. Description of the buttons

Parameters	Function Introduction
Refresh	Click to get latest status of user accessing to camera.
ID	Record serial number of user logging in camera.  Note: <ul style="list-style-type: none"> • There are at most 30 records shown at the list. • There is only one record if the same user logs in camera by the same IP address.
User Name	Name of user logging in camera.
User Level	Level of user logging in camera.
IP Address	Device IP address where user logging in camera web located.
Login Time	Camera system time of user logging in camera.

Access List

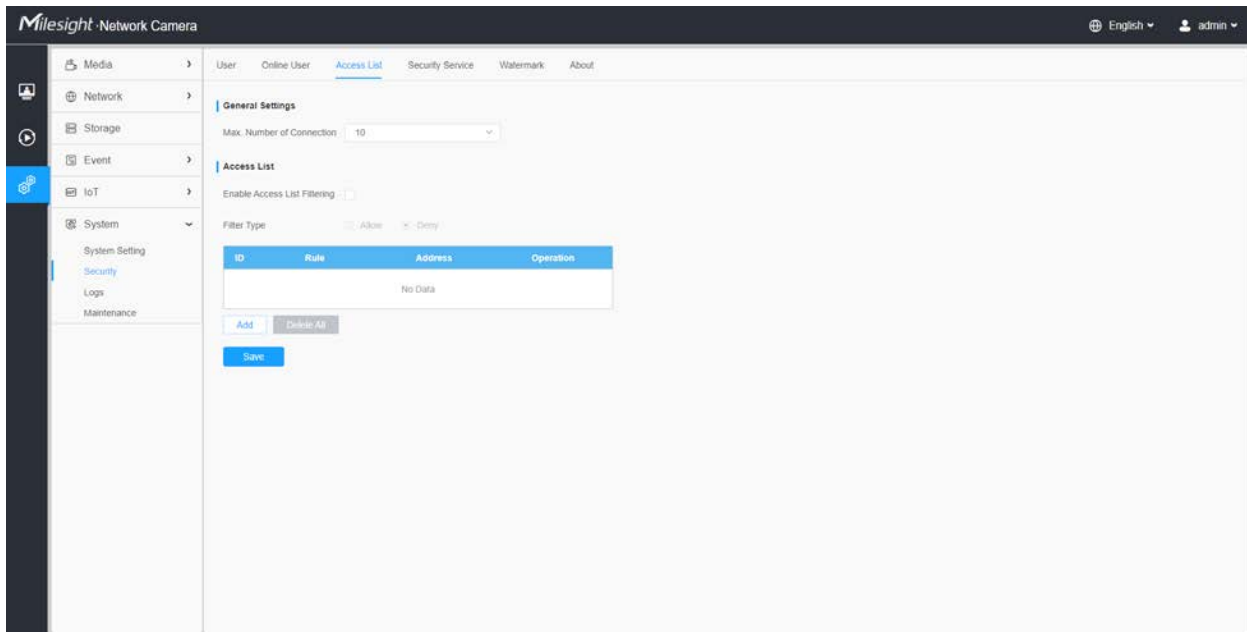
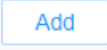
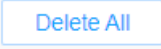

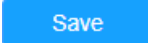

Table 64. Description of the buttons

Parameters	Function Introduction
General Settings	Max. Number of Connection: Select the maximum number of concurrent streaming. Options include No Limit, 1~10.
Access List	Enable Access List Filtering: Able to access or restrict access for some IP address.

Parameters	Function Introduction	
Access List	Filter type: Allow or deny access.	
		Rule: Single, Network and Range are available. IP address: Input the address to get the access to the device.
		Delete all the access list.
		Edit the selected IP on access list.
		Delete the selected IP on access list.
	Save the configuration.	

Security Service

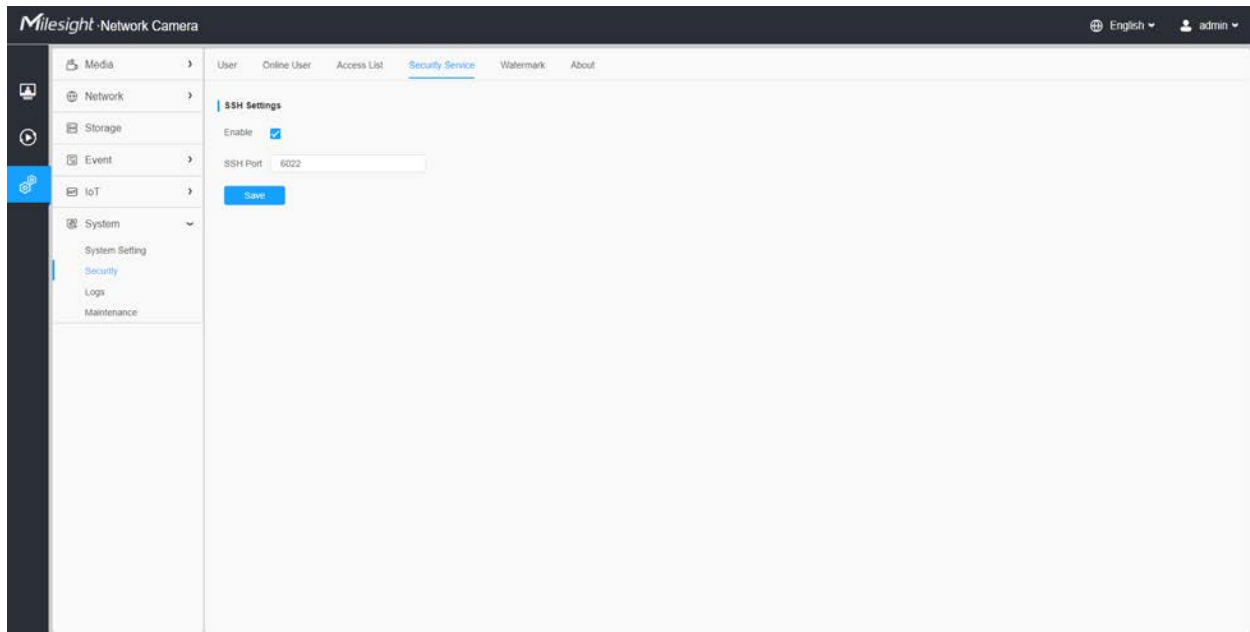
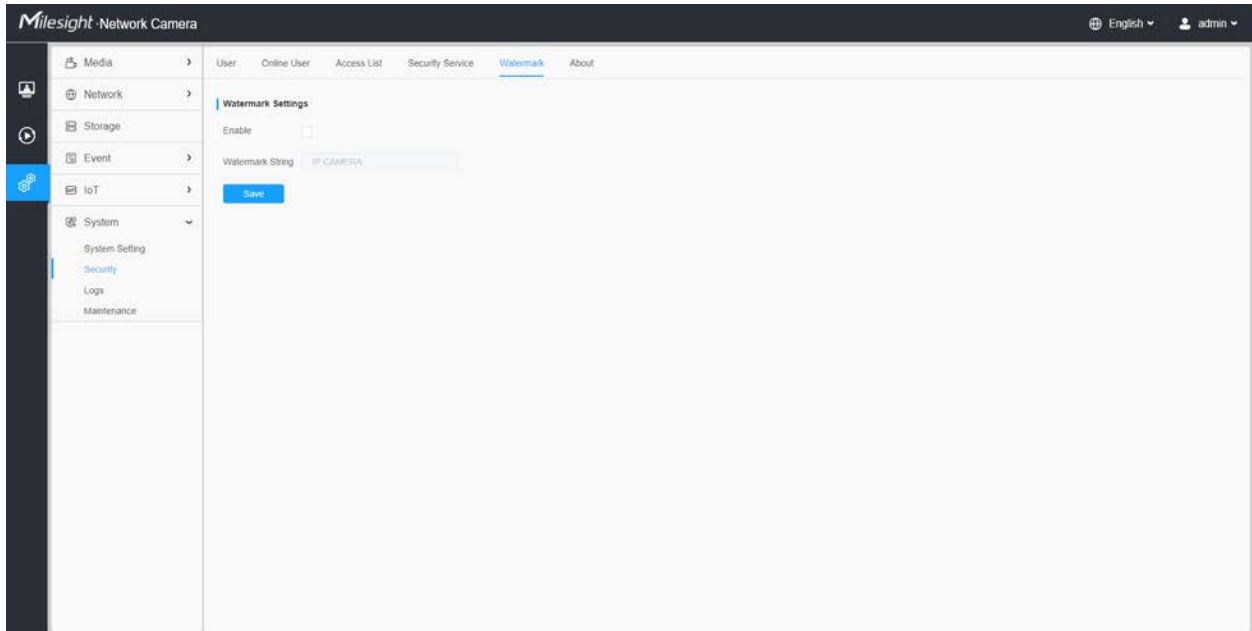

Table 65. Description of the buttons

Parameters	Function Introduction
SSH Settings	Secure Shell (SSH) has many functions: it can replace Telnet and also provides a secure channel for FTP, POP, even for PPP.

Watermark



Watermarking is an effective method to protect information security, realizing anti-counterfeiting traceability and copyright protection. Milesight Network cameras supports Watermark function to ensure information security.

About

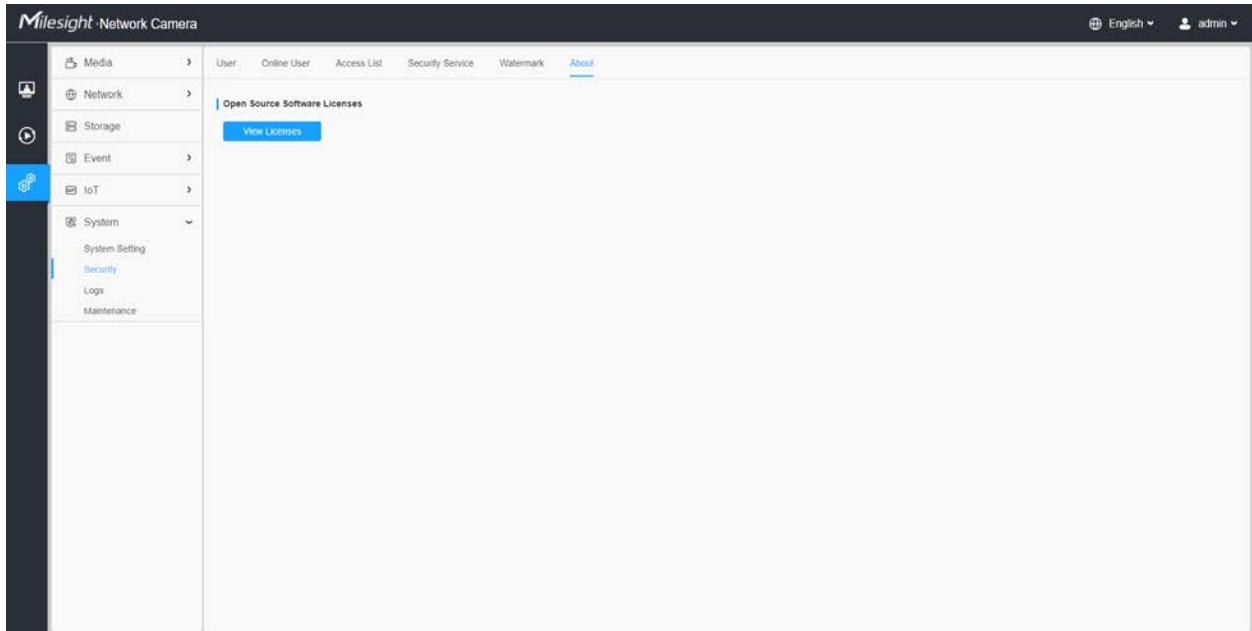

User can view some open source software licenses about the camera by clicking the View Licenses button.

Logs

The logs contain the information about the time and IP that has accessed the camera through web.

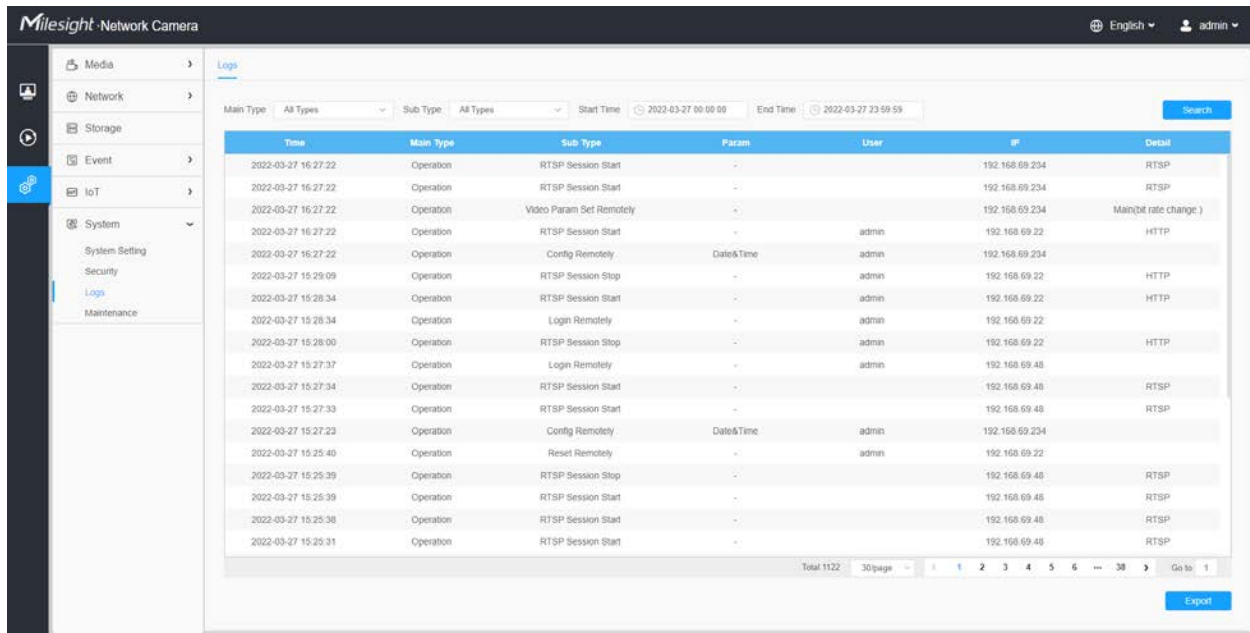
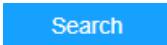



Table 66. Description of the buttons

Parameters	Function Introduction
Main Type	There are five main log types: All Type, Event, Operation, Information, Exception and Smart .
Sub Type	On the premise that main type has been selected, select the sub type to narrow the range of logs.
Start Time	The time log starts.
End Time	The time log ends.
	Search the logs.
	Export the logs.

Parameters	Function Introduction
Go to	Input the number of logs' page.

Maintenance

Here you can configure System Maintenance and Auto Reboot.

System Maintenance

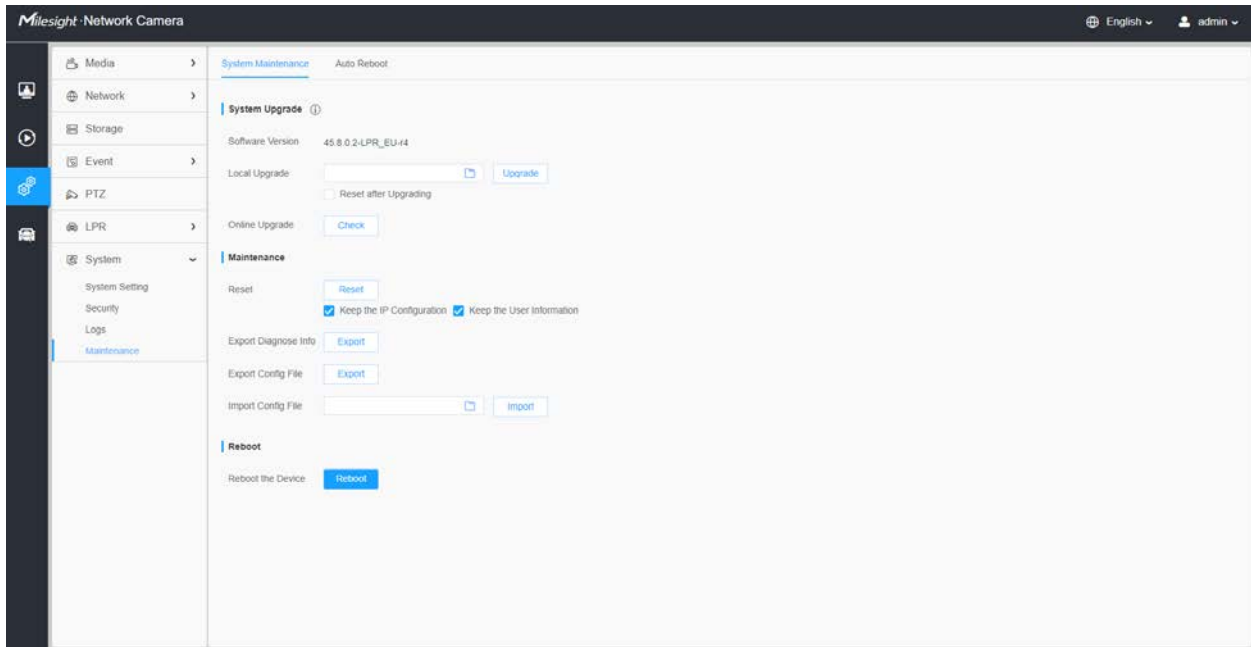



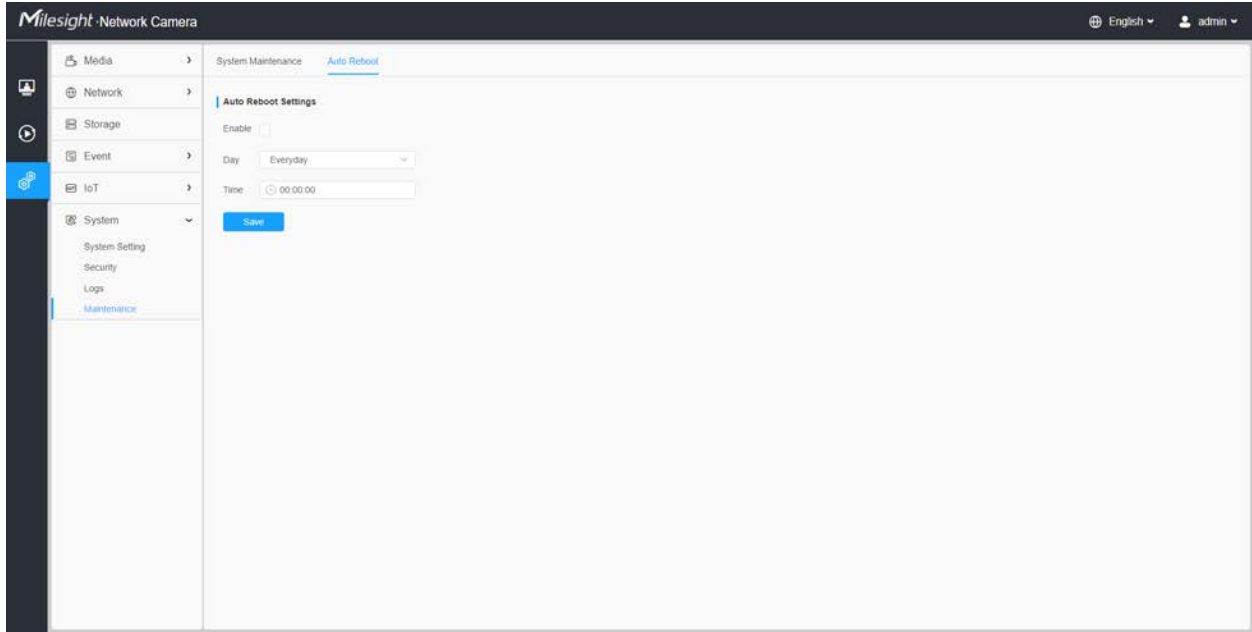

Table 67. Description of the buttons

Parameters	Function Introduction
<p style="text-align: center;">System Upgrade</p>	<p>Software Version: The software version of the camera.</p> <p>Local Upgrade: Click the "Browse" button and select the upgrading file, then click the "Upgrade" button to upgrade. After the system reboots successfully, the update is done.</p> <p>You can check "Reset after Upgrading" to reset the camera after upgrading it.</p> <p>Online Upgrade: Click the "Check" button to check the current latest firmware version on our website, and then click "OK" to upgrade to this version.</p> <p>It will prompt "The current version is the latest version" if your camera is already the latest version.</p> <div style="border: 1px solid #00aaff; background-color: #00aaff; color: white; padding: 5px; text-align: center; margin: 10px 0;"> × Tips </div> <div style="text-align: center; margin: 10px 0;">  The current version is the latest version. </div> <div style="text-align: center; margin: 10px 0;"> OK </div> <p> Note: Do not disconnect the power of the device during the update. The device will be restarted to complete the upgrading.</p>

Parameters	Function Introduction
<p style="text-align: center;">Maintenance</p>	<p>Reset: Click "Reset" button to reset the camera to factory default settings.</p> <p>Keep the IP Configuration: Check this option to keep the IP configuration when resetting the camera.</p> <p>Keep the User information: Check this option to keep the user information when resetting the camera.</p> <p>Export Diagnose Info: Click this button to export logs and system information of the device operation status.</p> <p> Note: The file format is ".txt".</p> <p>Export Config File: Click this button and a window will pop up as shown below:</p> <div data-bbox="591 730 1390 1062" style="border: 1px solid #ccc; padding: 10px; background-color: #f9f9f9;"> <div style="background-color: #0070c0; color: white; padding: 5px; display: flex; justify-content: space-between; align-items: center;"> File Encryption Configuration × </div> <div style="padding: 10px;"> <p style="margin-bottom: 10px;">Input the encryption password <input style="width: 100%;" type="text"/></p> <p>Confirm <input style="width: 100%;" type="text"/></p> <div style="display: flex; justify-content: center; gap: 20px; margin-top: 10px;"> Save Cancel </div> </div> </div> <p>You need to enter and confirm password again, then click save button to export configuration file.</p> <p>Import Config File: Click this button, then a window will pop up and you can click "OK" to update the configuration.</p> <p>It will pop up a window to prompt "Input the password of config file" , then enter password and click save button to import configuration file.</p> <div data-bbox="591 1327 1390 1587" style="border: 1px solid #ccc; padding: 10px; background-color: #f9f9f9;"> <div style="background-color: #0070c0; color: white; padding: 5px; display: flex; justify-content: space-between; align-items: center;"> File Encryption Configuration × </div> <div style="padding: 10px;"> <p style="margin-bottom: 10px;">Input the encryption password <input style="width: 100%;" type="text"/></p> <div style="display: flex; justify-content: center; gap: 20px; margin-top: 10px;"> Save Cancel </div> </div> </div> <p> Note:</p> <p>Export and import the same configuration file. Password must be the same.</p>

Auto Reboot



Set the date and time to enable Auto Reboot function, the camera will reboot automatically according to the customized time in case that camera overload after running a long time.

Chapter 3. Road Traffic Management

3.1 Product Description



3.1.1 Product Overview

Milesight Road Traffic Management Camera combines video surveillance with AI, ANPR, 3D Radar and other cutting-edge technologies to help traffic management agencies systematically and intelligently monitor and understand road users' behavior and gain valuable insights based on real-time data to optimize traffic flow, minimize accident risks, and respond to emergencies more efficiently. It can be widely used in urban public security management systems, which can significantly improve management efficiency and make traffic smarter, safer and smoother.

3.1.2 Related Product

Table 68.

Product	Name
	AI Road Traffic Pro Bullet Plus Camera
	AI Road Traffic Radar Pro Bullet Plus Camera
	AI Road Traffic PTZ Bullet Camera
	AI Road Traffic PTZ Bullet Plus Camera

Product	Name
	AI Road Traffic Speed Dome Camera
	AI Road Traffic Supplement Light Pro Bullet Plus Camera

3.1.3 Hardware Overview

- AI Road Traffic Pro Bullet Plus Camera

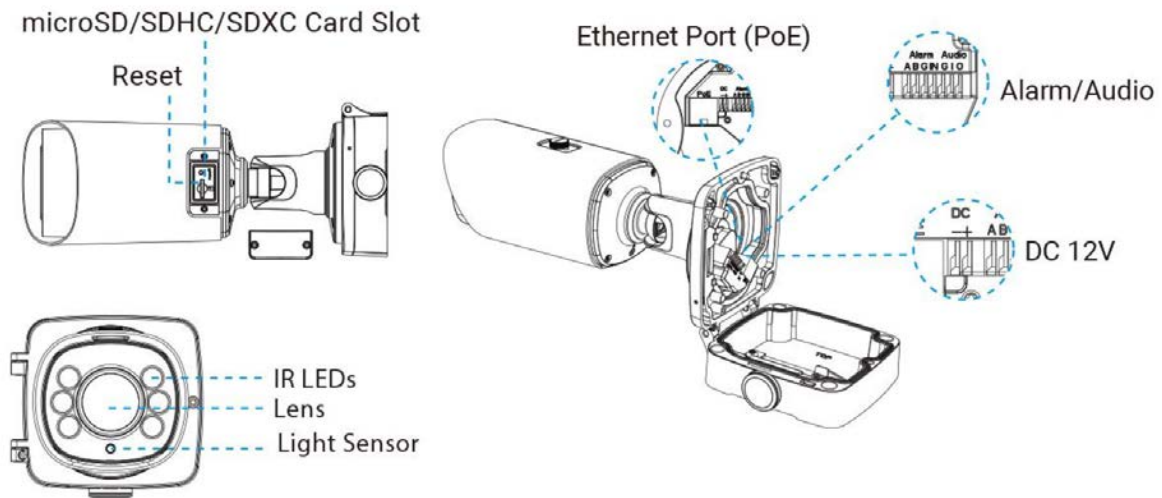

- AI Road Traffic Radar Pro Bullet Plus Camera

microSD/SDHC /SDXC Card Slot

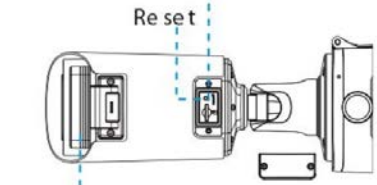

Radar(Optional)

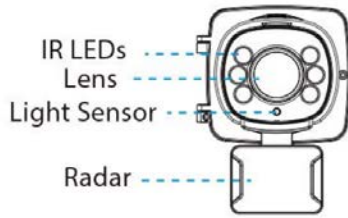

Ethernet Port (PoE)

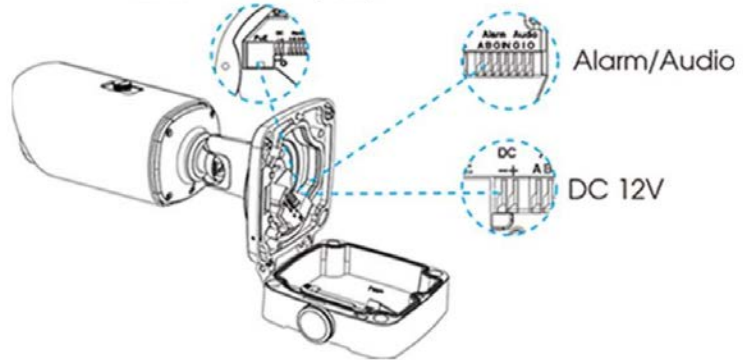

• AI Road Traffic PTZ Bullet Camera

microSD/SDHC/SDXC Card Slot

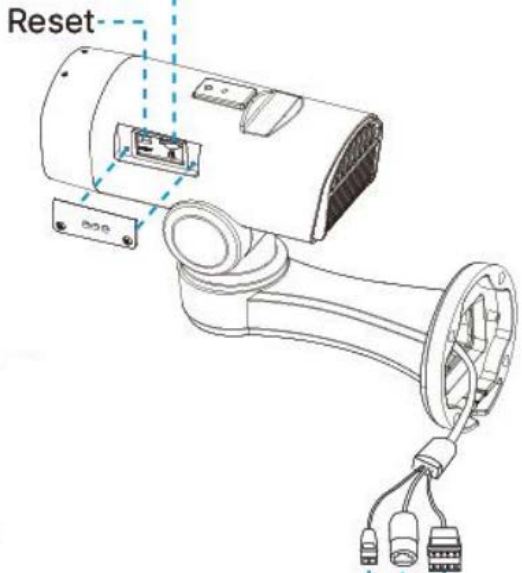

DC 12V
Alarm In/Out (Audio In/Out)
Ethernet Port (PoE+)

Micro SD/SDHC/SDXC Card Slot

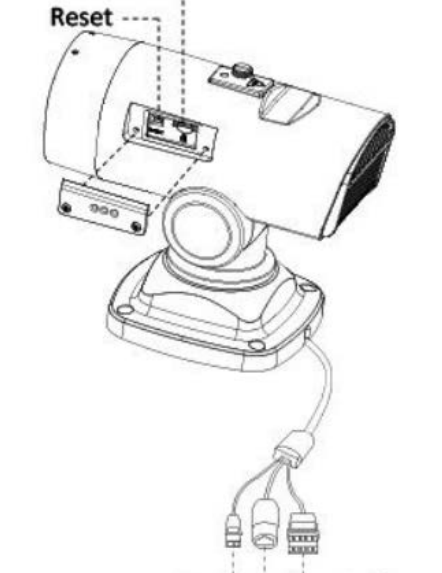

DC 12V
Alarm In/Out (Audio In/Out)
Ethernet Port (PoE+)

• AI Road Traffic PTZ Bullet Plus Camera

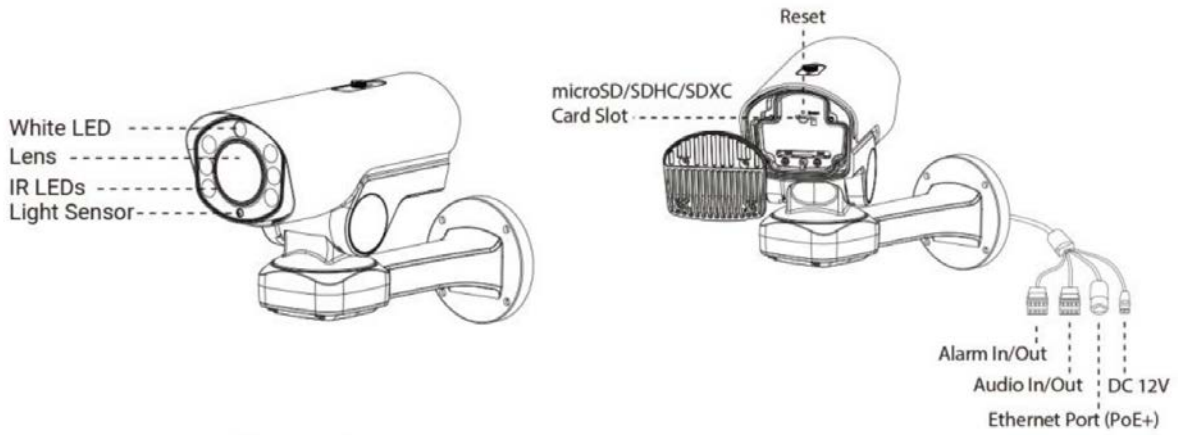

- AI Road Traffic Speed Dome Camera

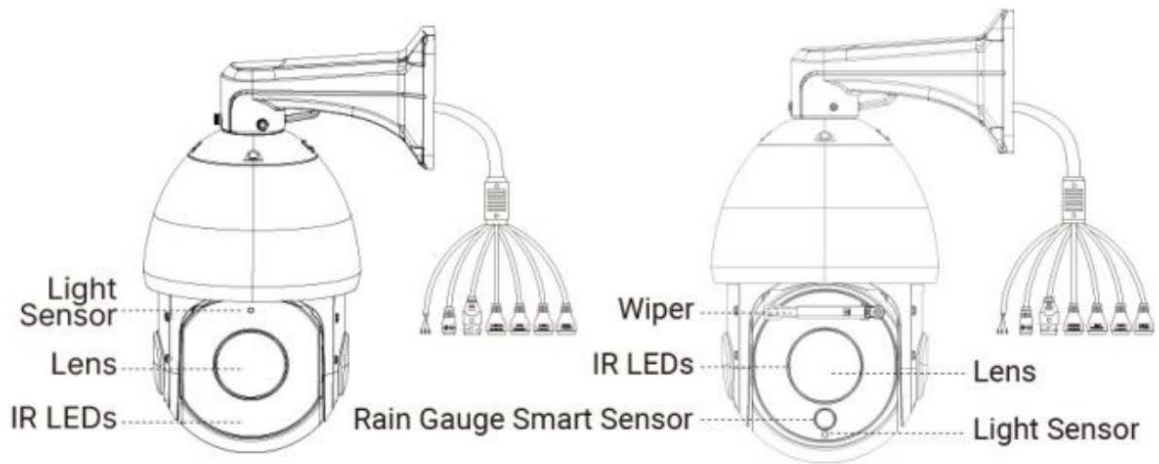

- AI Road Traffic Supplement Light Pro Bullet Plus Camera

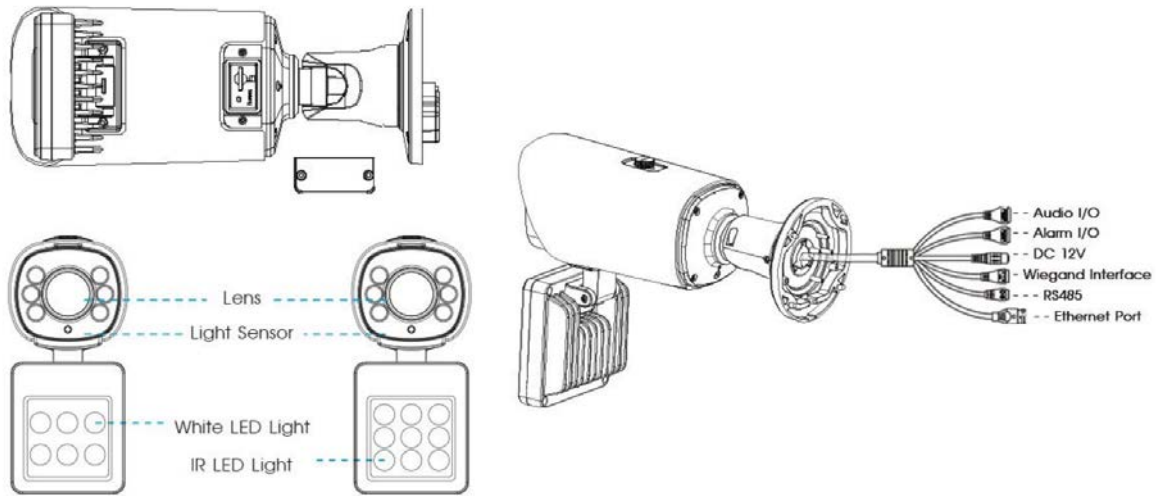

3.1.4 Related Documents

Table 69.

Document Type	Link
Road Traffic Management Camera	
Datasheet	https://www.milesight.com/static/file/en/download/datasheet/ipt/traffic/Milesight-Road-Traffic-Management-Datasheet-en.pdf
Quick Start Guide	https://www.milesight.com/static/file/en/download/user-manual/ipt/Milesight-Network-Camera-Quick-Start-Guide.pdf

3.2 Configuration Flow

The configuration flow of Road Traffic Management Camera is shown in the following figure.

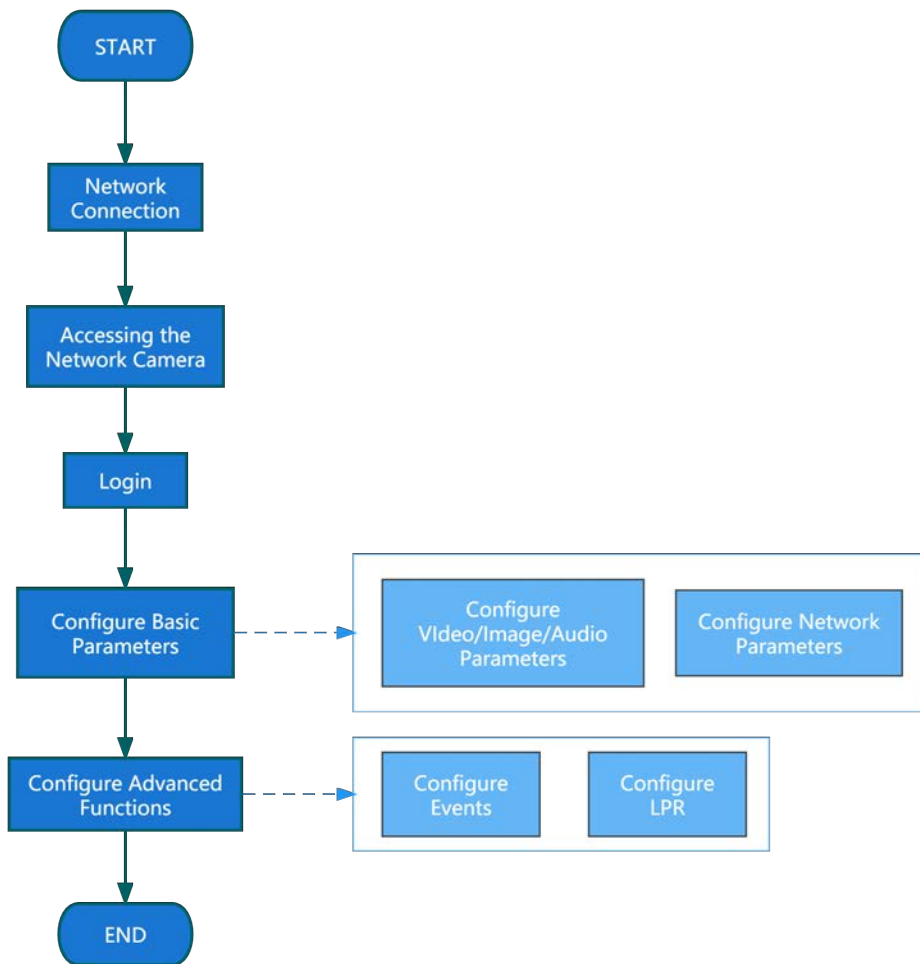

More configuration details is shown in the following table.

Table 70. Description of flow

Configuration	Description	Reference
Network Connection	Connect the network camera. You can set the camera over the LAN or dynamic IP connection.	Setting the Camera over the LAN (page 11)
Accessing the Network Camera	Accessing from IP address, web browser and Milesight back-end software are available.	Assigning an IP Address (page 12)
Configure Basic Parameters	After login the camera, you can adjust the video/image/audio/network parameters as needed.	Video (page 33) Image (page 36)
Configure Advanced Functions	Configure LPR-related settings and other advanced functions.	General (page 90)

3.3 Network Connection

Setting the Camera over the LAN

Connecting the camera to a switch or a router is the most common connection method. The camera must be assigned an IP address that is compatible with its LAN.

Connect the Camera to the PC Directly

In this method, only the computer connected to the camera will be able to view the camera. The camera must be assigned a compatible IP address to the computer. Details are shown as the following figure.



Connect via a Switch or a Router

Refer to the following figure to set network camera over the LAN via the switch or router.

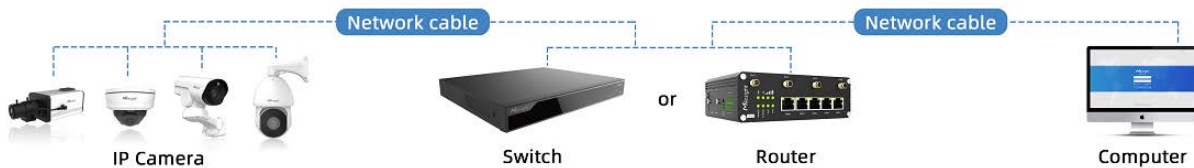

Dynamic IP Connection

Step1: Connect the network camera to a router;

Step2: On the camera, assign a LAN IP address, the Subnet mask and the Gateway;

Step3: On the router, set port forwarding. E.g. 80, 8000 and 554 ports. The steps for port forwarding vary depending on different routers. Please look up the router's user manual for assistance with port forwarding;

Step4: Apply a domain name from a domain name provider;

Step5: Configure the DDNS settings in the setting interface of the router;

Step6: Visit the camera via the domain name.

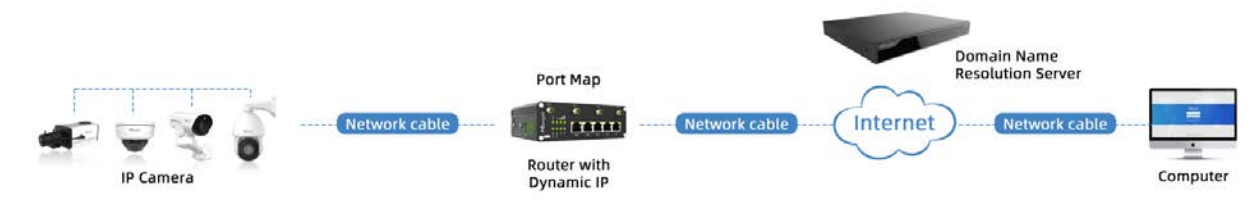

3.4 Accessing the Network Camera

Assigning an IP Address

The Network Camera must be assigned an IP address to be accessible. The default IP address of Milesight network cameras is 192.168.5.190.

You can also change the IP address of the camera via Smart Tools or browser. Please connect the camera in the same LAN of your computer.

Assigning an IP Address Using Smart Tools

Smart Tools is a software tool which can automatically detect multiple online Milesight network cameras in the LAN, set IP addresses, and manage firmware upgrades. It's recommended to use when assigning IP addresses for multiple cameras.

Step1: Install Smart Tools (The software could be downloaded from our website);

Step2: Start Smart Tools, click the IPC Tools page, then enter the device information, such as IP address, MAC address, Status, Port number, Netmask, and Gateway, then all related Milesight network camera in the same network will be displayed. Details are shown as the figure below;

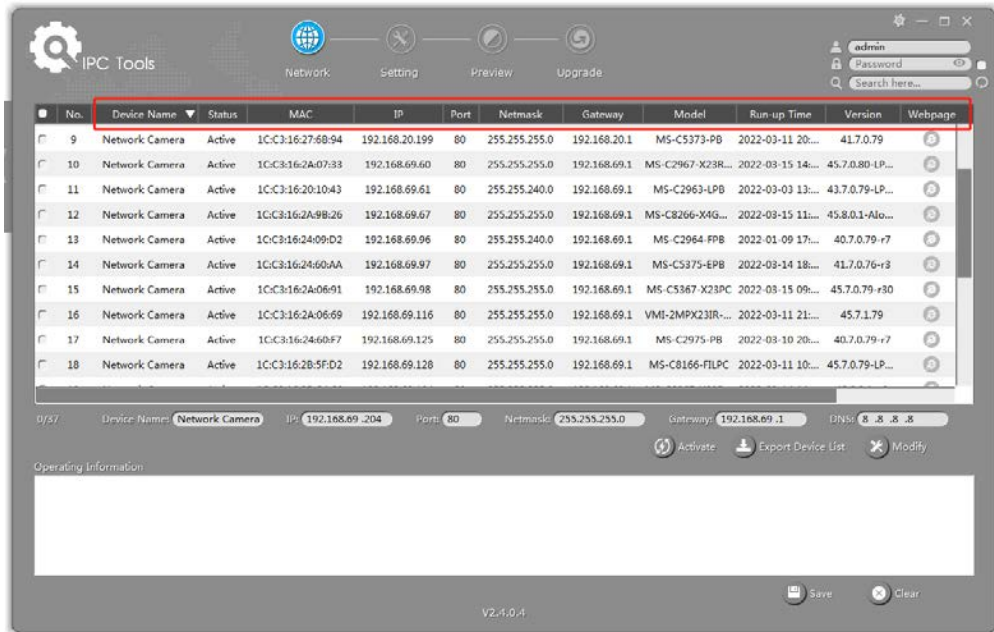

Step3: Select a camera or multiple cameras according to the MAC addresses;

Select single camera:

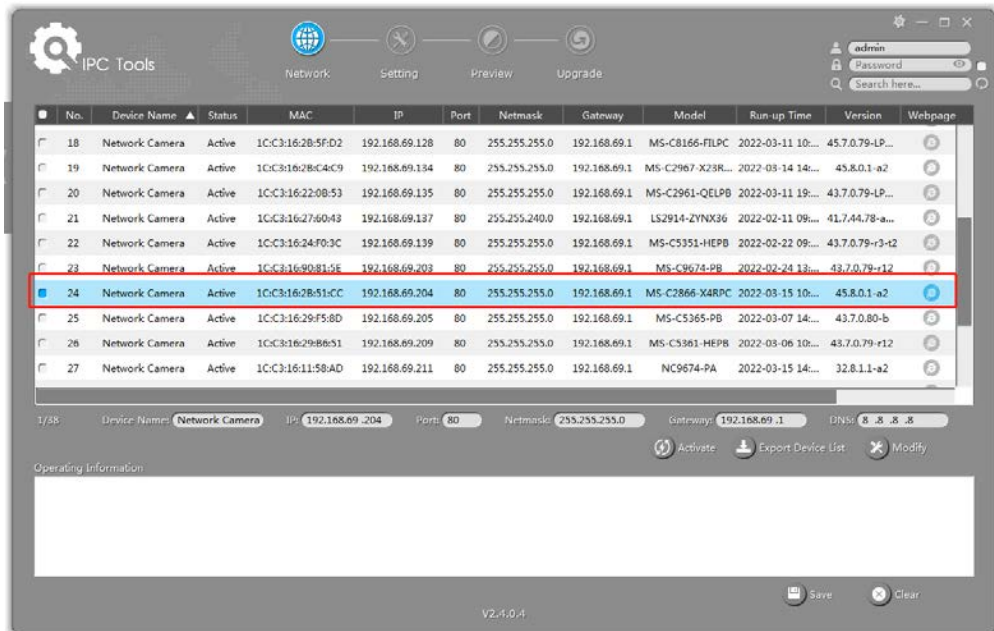

Select multiple cameras:

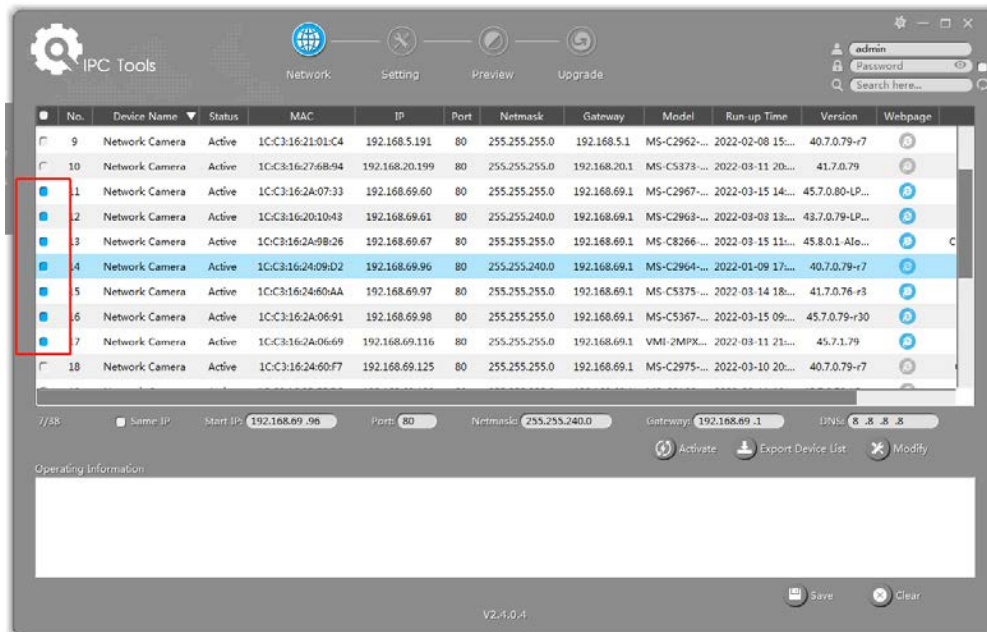

Step4: If the selected camera shows "Inactive" in the status bar, click "Activate" to set the password when using it for the first time. You can also set the security questions when activating the camera in case that you forget the password (You can reset the password by answering three security questions correctly). Click 'Save' and it will show that the activation was successful.

Note:

- Password must be 8 to 32 characters long, contain at least one number and one letter.
- You need to upgrade Smart Tools version to V2.4.0.1 or above to activate the camera.

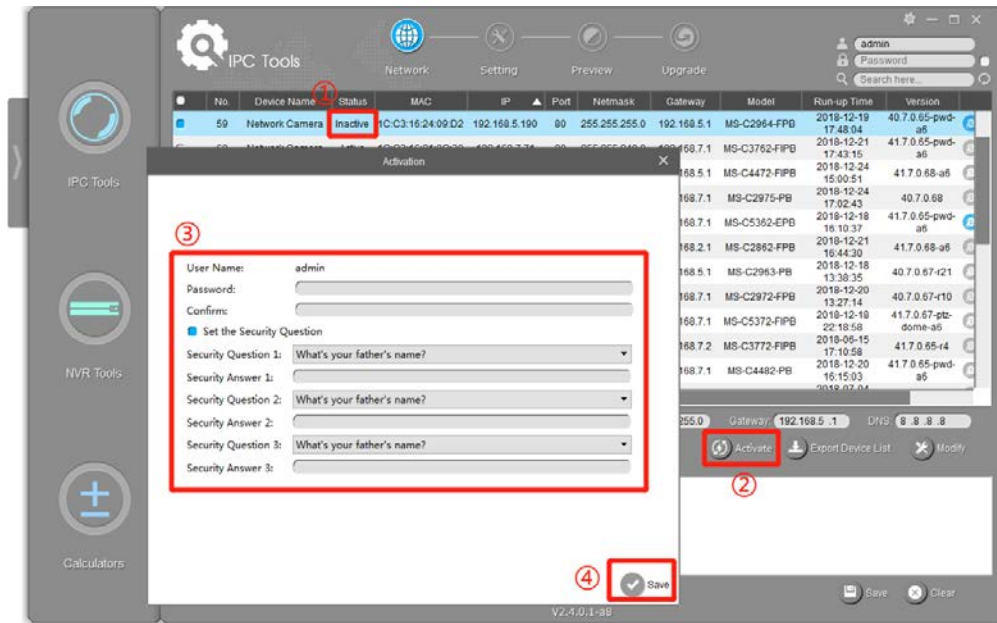

Step5: After activation, you can change the IP address or other network values, and then click “Modify” button.

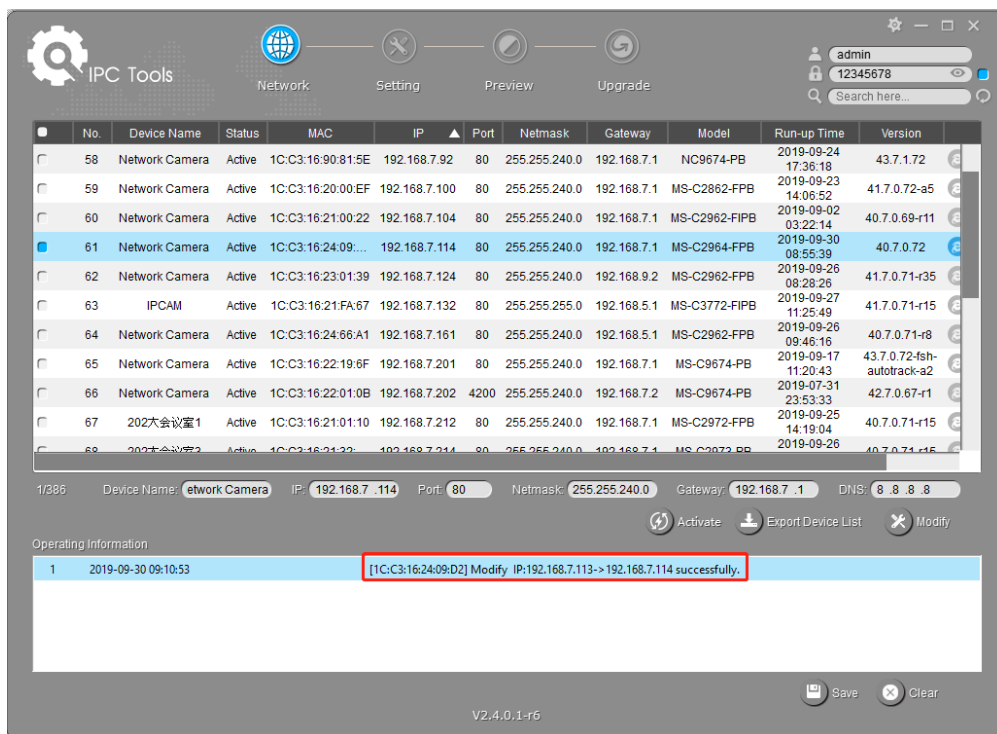

Step6: By double clicking the selected camera or the browser of interested camera, you can access the camera via web browser directly. The Internet Explorer window will pop up.

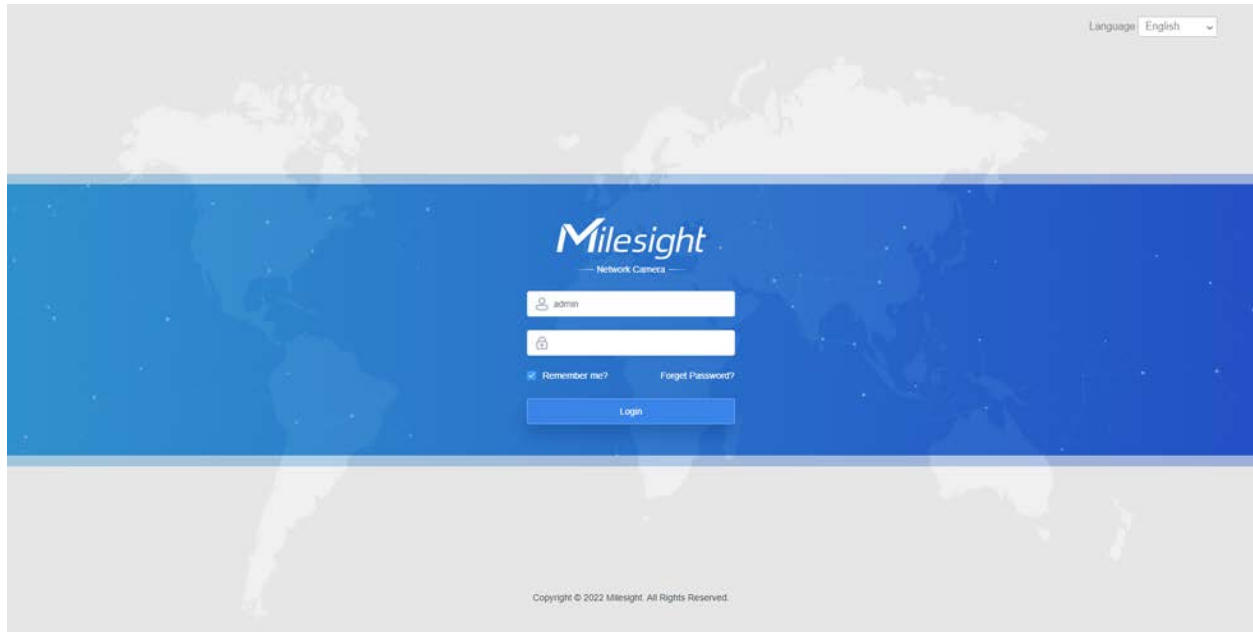

More usage of Smart Tools, please refer to the ***Smart Tools User Manual***.

Assign An IP Address via Browser

If the network segment of the computer and that of the camera are different, please follow the steps to change the IP address:

Step1: Change the IP address of computer to 192.168.5.0 segment, here are two ways as below:

a. Start-->Control Panel-->Network and Internet Connection-->Network Connection-->Local Area Connection, and double click it;

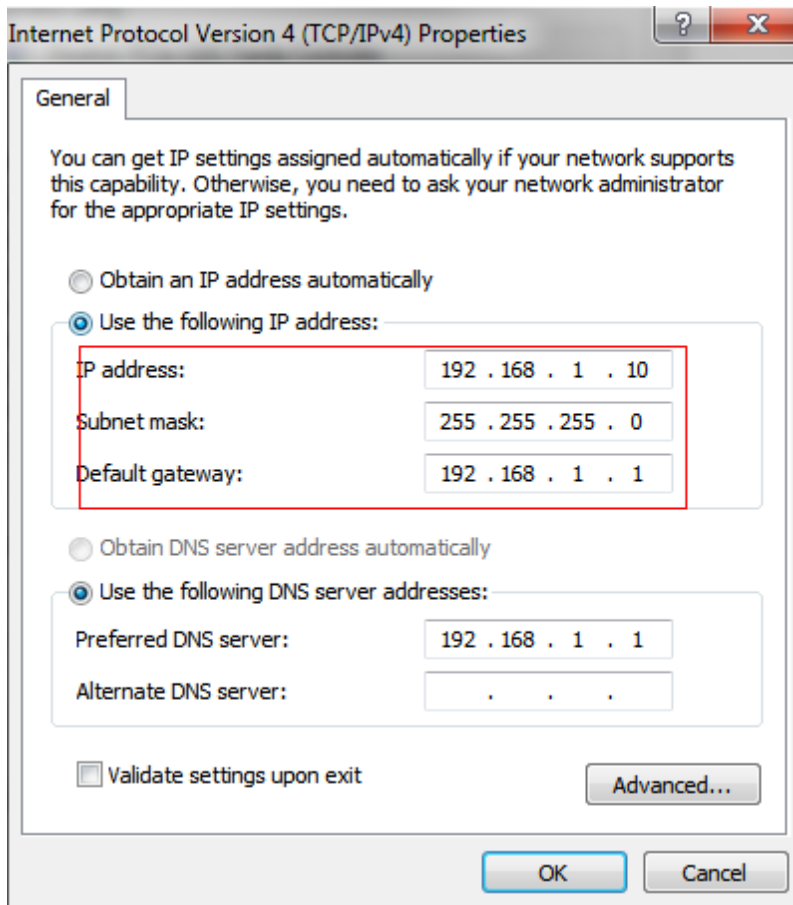

b. Click "Advanced", and then click "IP settings"--> "IP address"--> "Add". In the pop-up window, enter an IP address that in the same segment with Milesight network camera (e.g. 192.168.5.61, but please note that this IP address shall not conflict with the IP address on the existing network);

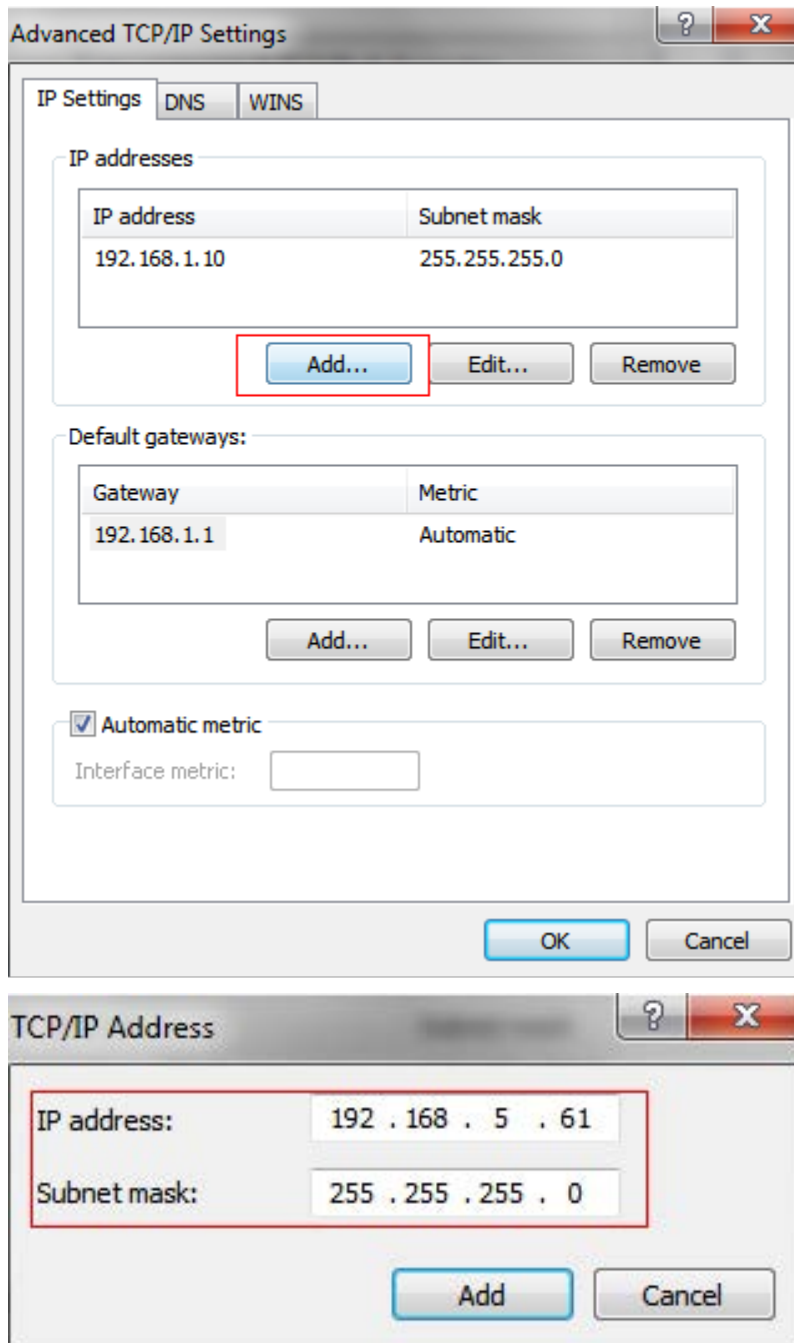

Step2: Start the browser. In the address bar, enter the default IP address of the camera: <http://192.168.5.190>;

Step3: You need to set the password first when using it for the first time. And you can also set three security questions for your device after activation. Then you can log in to the camera with the user name (admin) and a custom password.

 **Note:**

- Password must be 8 to 32 characters long, contain at least one number and one letter.
- You can click the “forget password” in login page to reset the password by answering three security questions when you forget the password, if you set the security questions in advance.

Step4: After login, please select “Settings” --> “Network” --> “Basic” --> “TCP/IP”. The Network Settings page appears (Shown as below Figure);

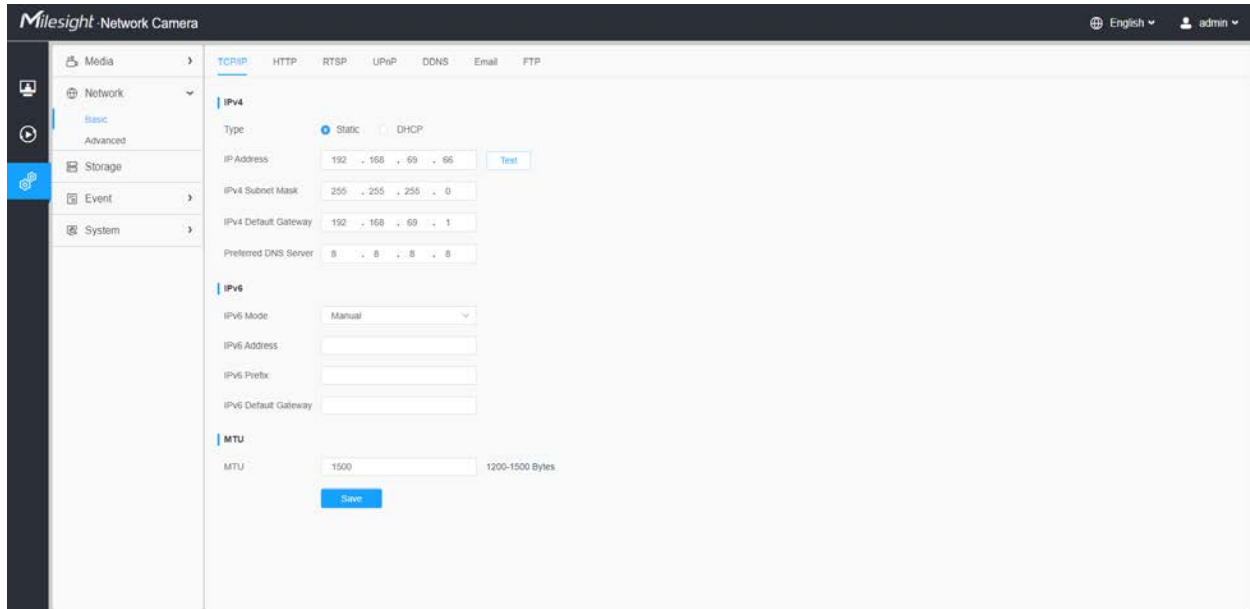

Step5: Change the IP address or other network values. Then click “Save” button;

Step6: The change of default IP address is completed.

Accessing from the Web Browser

The camera can be used with the most standard operating systems and browsers. And the camera was upgraded to support Plugin-Free Mode. In Plugin-Free Mode, you can preview the video on the browser without plugin. Currently Plugin-Free Mode is supported in Firefox & Google Chrome & Safari & Edge browser for Windows system, MAC system, iOS system and Android system. Both H.265&H.264 video codec are supported in Plugin-Free Mode for camera, and it will play the secondary stream by default.

Note:

- For more details about set plugin-free mode of Milesight camera, please refer to <https://milesight.freshdesk.com/a/solutions/articles/69000643388>.

Accessing from Mile sight Back-end Software

Accessing from Mile sight NVR (Network Video Recorder)

Mile sight NVR Series can work with Mile sight network cameras. Based on embedded Linux operation system, Mile sight NVR Series manages and stores HD video data. It owns multi-disk management systems, front end HD device management system, HD video analysis system and high-capacity system for video. Also, it adopts the technology of high flow capacity data network transmitting&transmission, with multi-channel video decoding, to achieve functions like intelligent management, safe storage, HD decoding, etc.

For detailed information about how to use the Mile sight NVR Series, please refer to ***Mile sight NVR User Manual***.

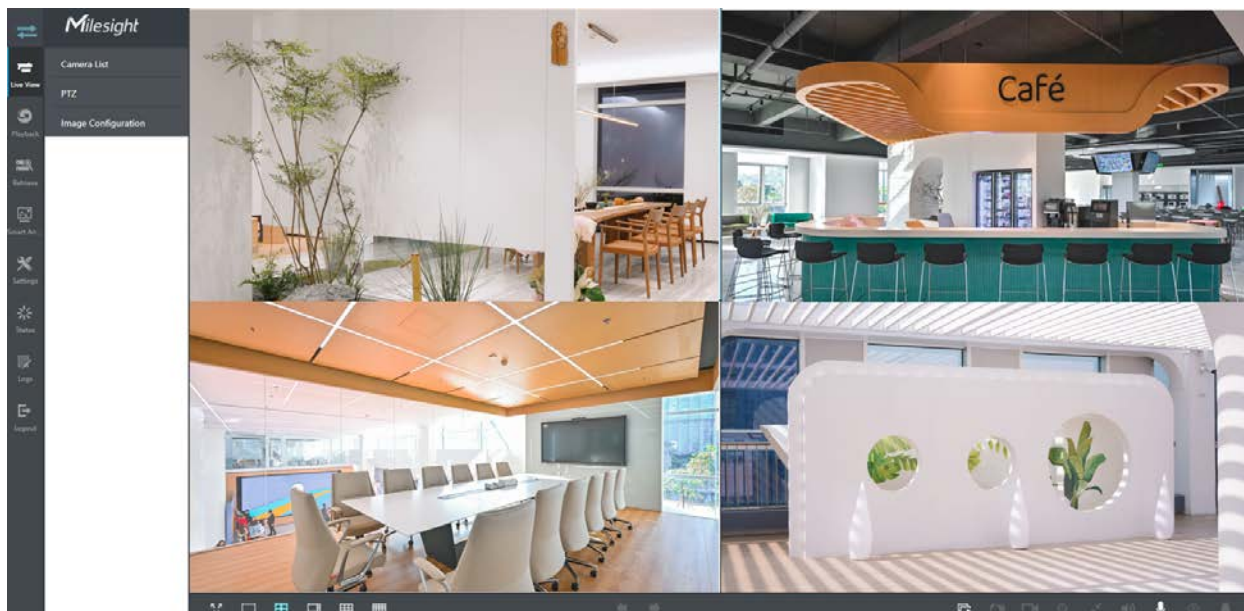

Accessing from Mile sight CMS (Center Management System)

Mile sight Central Management System (CMS) is a central management system for Mile sight network cameras and Mile sight NVR. It is an intelligent surveillance solution for users to control up to 256 devices, to remote preview and playback more conveniently. With high-efficient management performance, Mile sight CMS software offers users a superior administration experience in such centralized system. Featured with friendly UI design, the intelligent video management system CMS allows users of all levels to setup and deploy solutions as easy as ABC. Moreover, E-map function provides users a smarter way to show the devices spatial distribution. The software could be downloaded from our website <https://www.mile sight.com/>.

Please install Milesight CMS; then launch the program to add the camera to the channel list. For detailed information about how to use the software, please refer to ***Milesight CMS User Manual***.

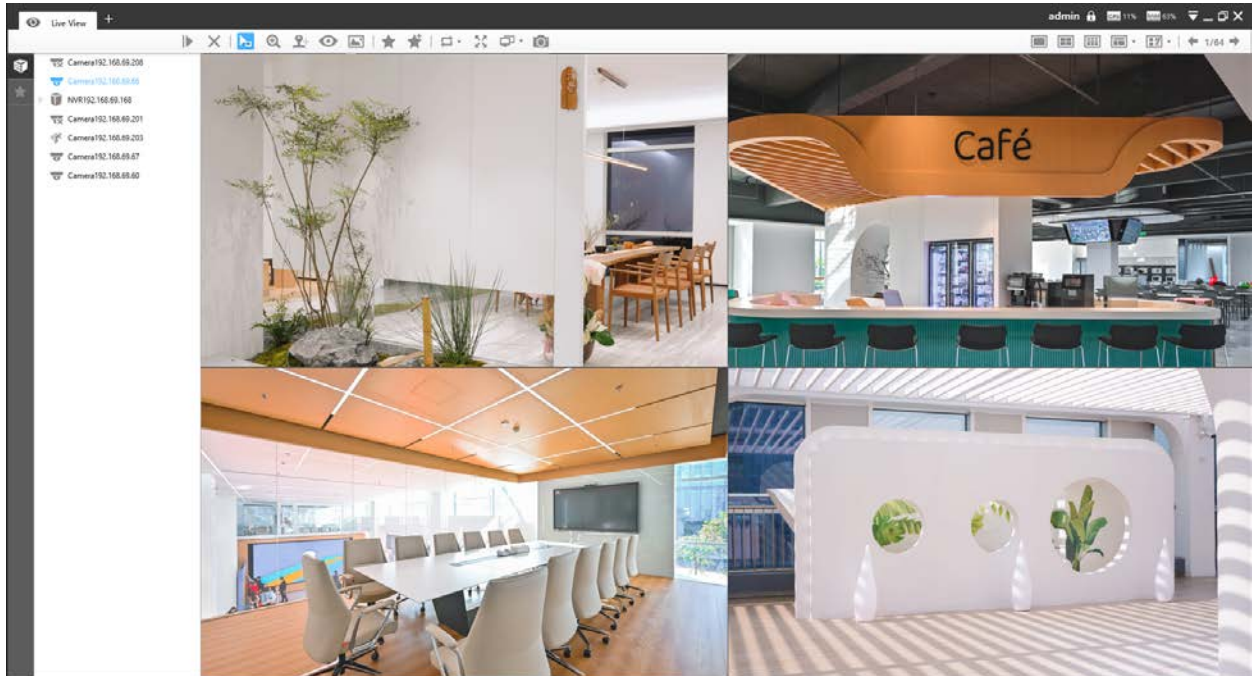

Accessing from Milesight VMS Enterprise (Video Management System)

Milesight VMS Enterprise is a professional and intelligent video management software for businesses. Together with our cameras, it can simplify and freshen up your video surveillance. With advanced C/S architecture, it fulfills your demands and expectations, with rich core functions including live view, record, E-Map, event alarm and smart analysis etc. The software could be downloaded from our website <https://www.milesight.com/>.

Please install Milesight VMS Enterprise; then launch the program to add the camera to the channel list. For detailed information about how to use the software, please refer to ***Milesight VMS Enterprise User Manual***.

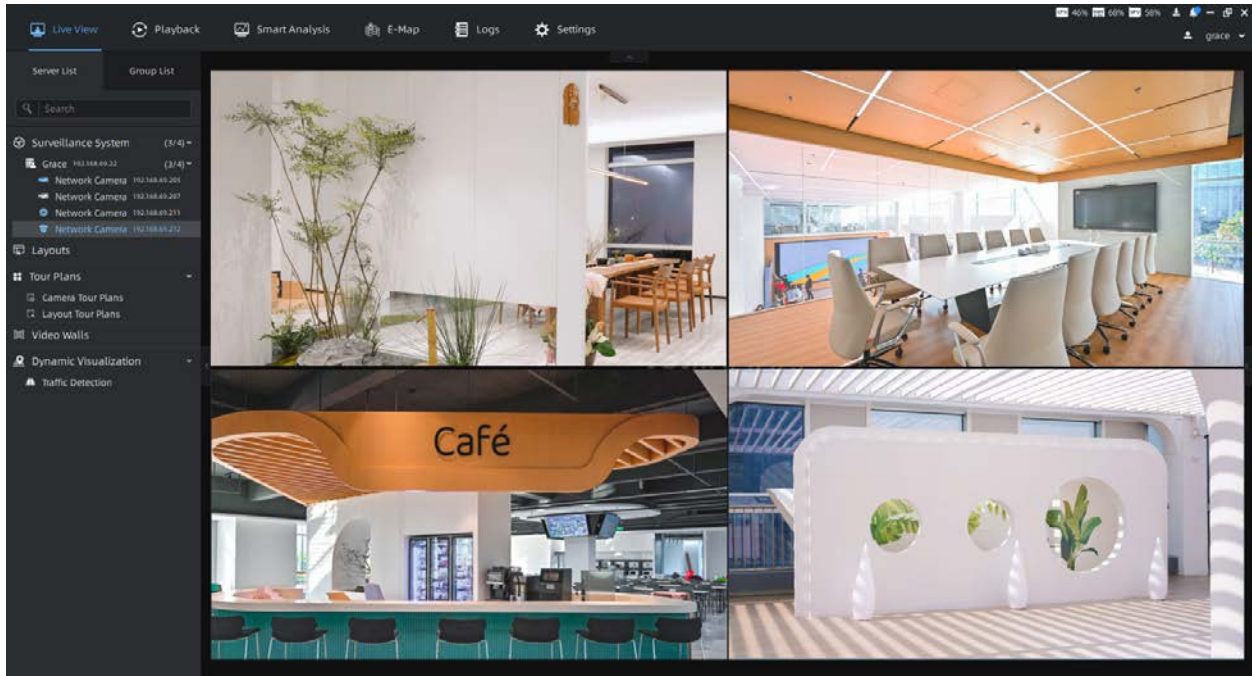

3.5 Live View

Live Video

After logging in the network camera web GUI successfully, user is allowed to view live video as follows.

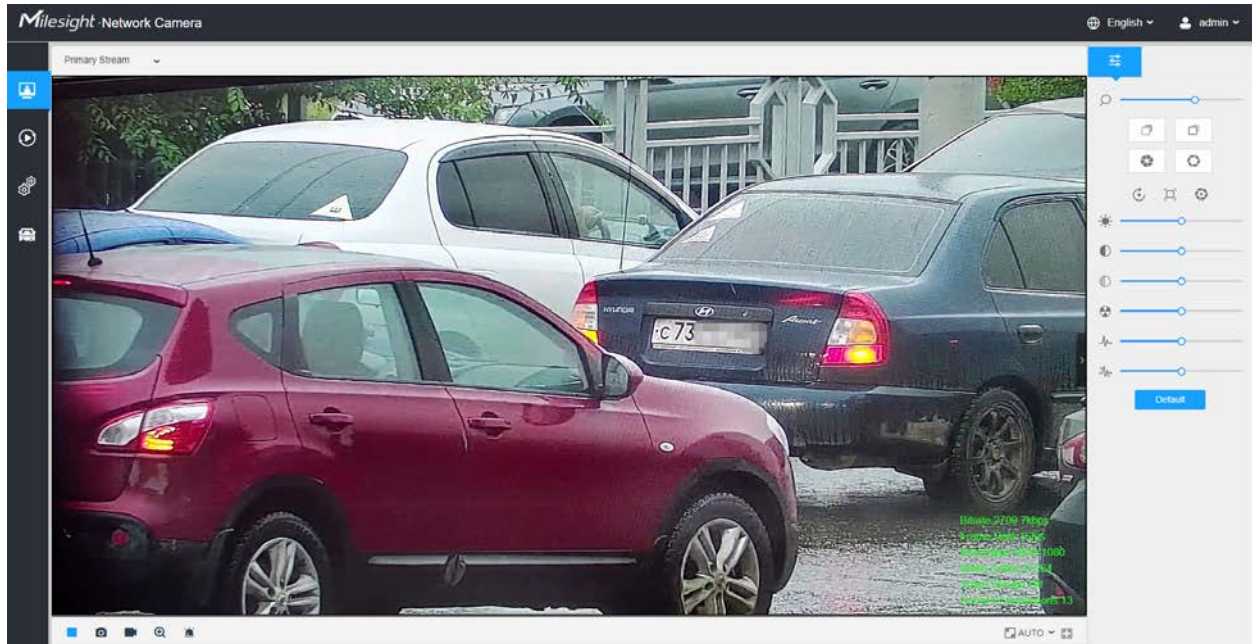



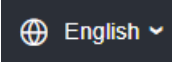
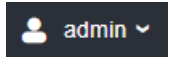
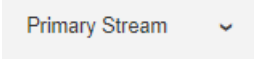

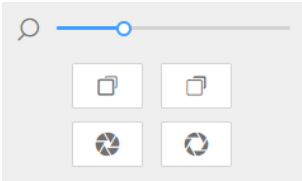



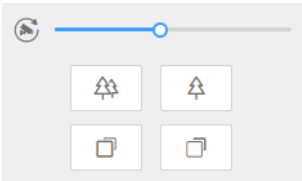





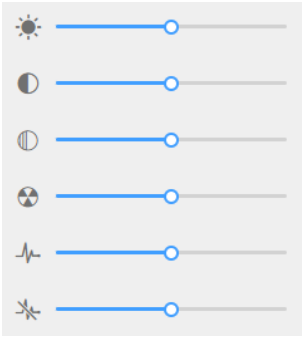

Table 71. Description of the buttons

No.	Parameter	Description
1	 Live Video	Click to access the live view page.
2	 Playback	Click to access the playback page.
3	 Settings	Click to access the configuration page.
4	 LPR Mode	Click to access the LPR Mode.
5	 English ▾	Click to select system language.
6	 admin ▾	Display the user name and click to logout.
7	 Primary Stream ▾	Choose the stream (Primary/Secondary/Tertiary) to show on the current video window.

No.	Parameter	Description
8	 Recording	When recording, the icon appears.
9	 Alarm	When an alarm of Motion Detection was triggered, the icon appears.
10	 Alarm	Except for the kinds of alarms above, when other alarms were triggered, the icon appears.
11	 Stop/Play	Stop/Play live view.
12	 Snapshot	Click to capture the current image and save to the configured path. The default path is: C:\VMS\+-1\ IMAGE-MANUAL.
13	 Start/Stop Recording	Click to Start Recording video and save to the configured path. The default path is C:\VMS\+-1\MS_Record. Click again to Stop Recording .
14	 Digital Zoom	When enabled, you can zoom in a specific area of video image with your mouse wheel.
15	 Manual Output	Manually trigger Camera Alarm Output.
16	 Window Size	Click to display images at a window size.
17	 Full Screen	Click to display images at full-screen.

No.	Parameter	Description
		<p>Zoom: Adjust the Zoom length of the lens.</p> <p> Note: Only work when your camera is equipped with motorized lens.</p>
		<p>Focus-/Focus+: Adjust focus of the lens.</p> <p> Note: Only work when your camera is equipped with motorized lens.</p>
		<p>Focus Speed: To adjust the speed of focus.</p> <p> Note: Only work when your camera is equipped with auto focus lens.</p>
		<p>Zoom-/Zoom+: Click to zoom in and zoom out.</p> <p> Note: Only work when your camera is equipped with auto focus lens.</p>
		<p>Lens Initialization, Auxiliary Focus and Auto Iris.</p> <p> Note:</p> <ul style="list-style-type: none"> • The Auto Iris is turned on by default when your camera is equipped with auto focus lens. • The Auto Iris support turn on/off when your camera is equipped with P-Iris.
		<p>Brightness: Adjust the Brightness of the scene.</p> <p>Contrast: Adjust the color and light contrast.</p> <p>Saturation: Adjust the Saturation of the image. Higher Saturation makes colors appear more "pure" while lower one appears more "wash-out".</p> <p>Sharpness: Adjust the Sharpness of image. Higher Sharpness sharps the pixel boundary and makes the image looks "more clear".</p> <p>2D DNR/3D DNR: Adjust the noise reduction level.</p> <p>Default: Restore brightness, contrast and saturation to default settings.</p>

PTZ Mode

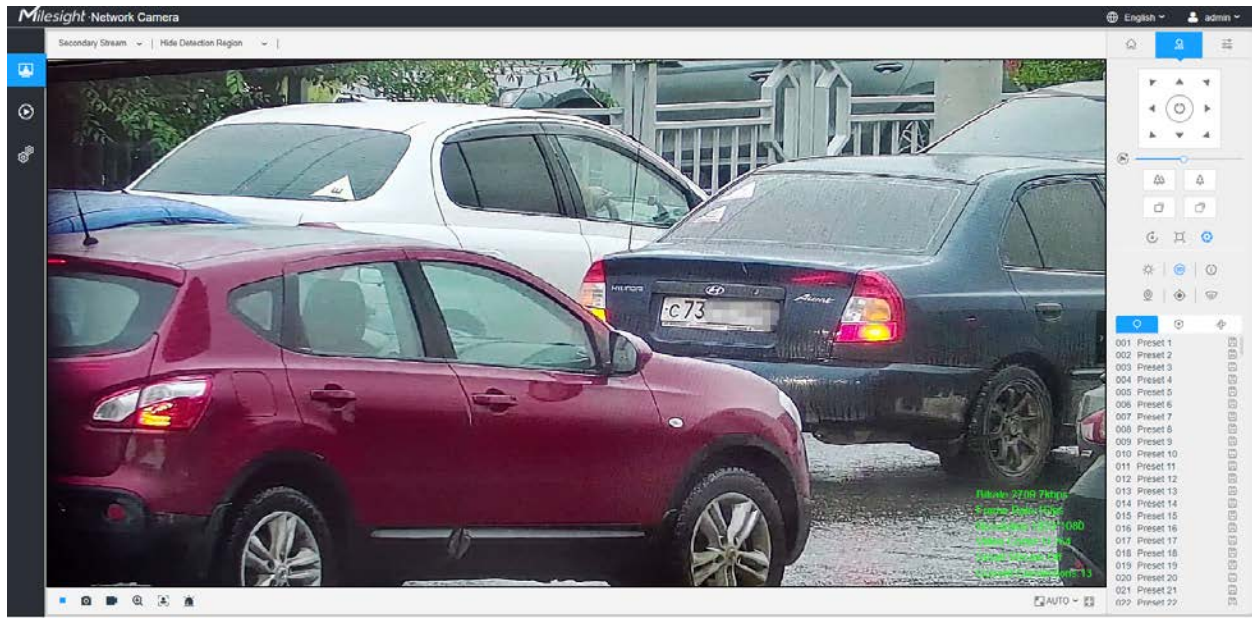

After logging in the PTZ network camera web GUI successfully, user is allowed to view live video as follows.







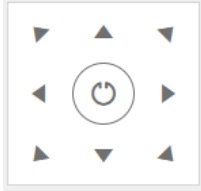



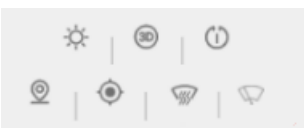

Operations on Live View Page

Note: For description of other buttons, you can refer to [Table 1 \(page 23\)](#).

Table 72. Description of the buttons

No.	Parameter	Description
	 <p>PTZ Control</p>	Navigation key is used to control the direction. The rotation key is used for auto-rotation.
	 <p>PTZ Speed</p>	To adjust the speed of pan/tilt movements, from 1 to 10 .

No.	Parameter	Description
	 Zoom-/Zoom+	Click to zoom in and zoom out.
	 Focus-/Focus+	Click to focus near or far of the lens.
		Lens Initialization, Auxiliary Focus and Auto Iris.  Note: The Auto Iris is turned on by default.
		Lighting For 30s: Click to open/ close the White LED for lighting 30s.  Note: Only for PTZ Bullet.
		3D Positioning: Click to enable/ disable 3D positioning.
		One-touch Patrol: Click to carry out the patrol.
		Auto Home: Click to enable Auto Home.
		Dehumidifying: Click to enable the fan working mode.
		Manual Wiper: Enable the wiper to wipe twice manually.
		Enable to set 300 preset positions for each regional view channel.
	Enable to set 8 patrol paths for each regional view channel.	
	Display the pattern.	

3D Positioning

3D Positioning allows user to use mouse clicking and dragging to control the PTZ.

Steps:

1. Click  on the toolbar of Live View interface.
2. Operate the 3D positioning function
 - Left click a position of the Live View, and the corresponding position will be moved to the center of the Live View.

- Hold down the left mouse button and drag the mouse to the lower right or upper right on the Live View, then you can see a blue rectangle. The corresponding position will be moved to the center of the Live View and Zoom in.
- Hold down the left mouse button and drag the mouse to the lower left or upper left on the Live View, then you can see a blue rectangle. The corresponding position will be moved to the center of the Live View and Zoom out.
- The Bigger the rectangle is, the smaller zoom in/out will be acted.

Set / Call a Preset / Patrol / Pattern

A preset is a predefined image position. You can click the call button from the preset list to quickly go to the desired image position.

Set a preset:

Step1: In the PTZ control panel, select a preset number from the preset list, and you can also customize the preset name displayed on the screen. The patrol name displayed on the screen will also be customized if you customize preset name and set a patrol as shown below;



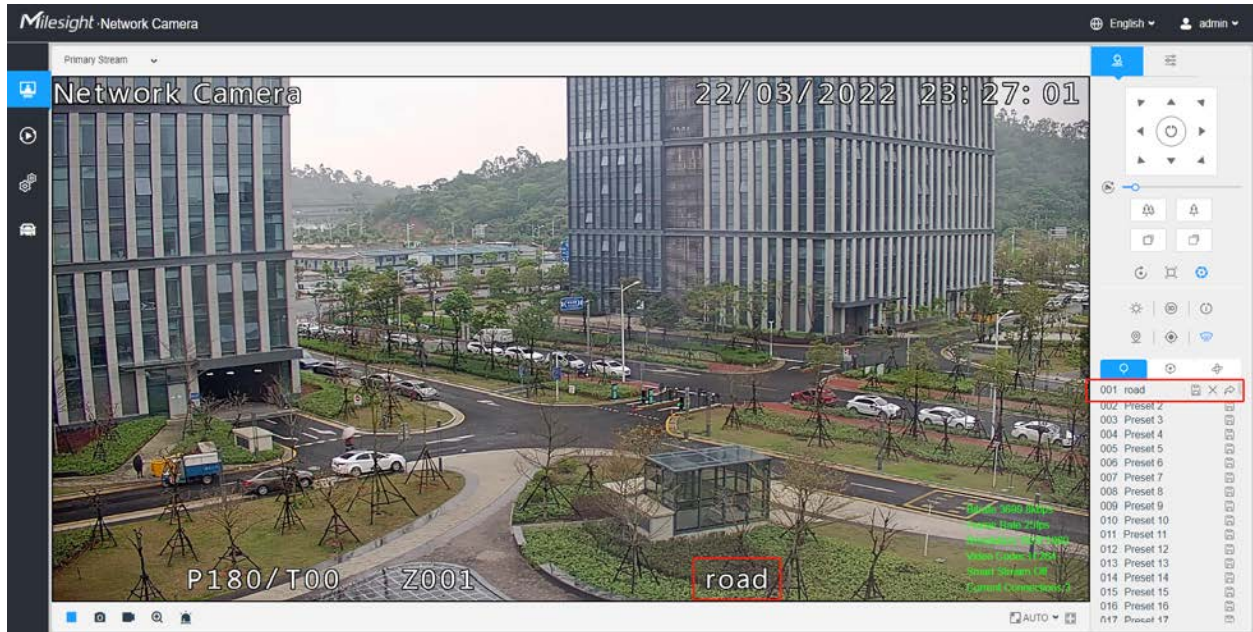

Step2: Use the PTZ control buttons to move the lens to the interested position;

Step3: Click  to save the setting of the current preset;

Step4: Click  to delete the chosen preset.

 **Note:** Up to 300 presets can be configured (18 presets are not modifiable). Up to 300 presets can be configured (for each regional view channel).

Calling a preset:

Select a defined preset from the preset list and click  to call the preset.

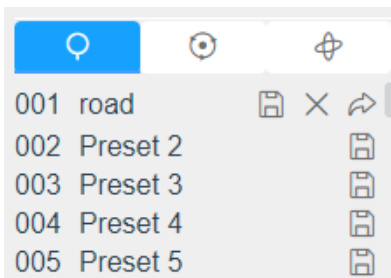

 **Note:** The following presets are predefined with special commands. You can only call them but can't configure them. For example, preset 037 is the "Self Check". If you call the preset number 037, the PTZ camera will start self check function at once.

Table 73. Special Presets

Special Preset	Function	Special Preset	Function
33	Auto Flip(Speed Dome only)	43	Path7
34	Go to Zero	44	Path8
35	Self Check	45	Pattern1
36	Patrol	46	Pattern2
37	Path1	47	Pattern3
38	Path2	48	Pattern4
39	Path3	49	Stop Scan
40	Path4	50	Auto Scan
41	Path5	53	Wiper
42	Path6		





Set / Call a patrol

A patrol is a memorized series of preset function. It can be configured and called on the patrol setting list. You can customize up to 8 patrols and it can be configured with 48 presets. Before configuring the patrol, you should make sure that the presets you want to add to the patrol have been defined.

Set a patrol:

Step1: In the PTZ control panel, click  to enter the patrol settings interface;

Step2: Select a patrol number, the setting icon will appear , click it;

Step3: Click  to add presets to this patrol, as shown in Figure;

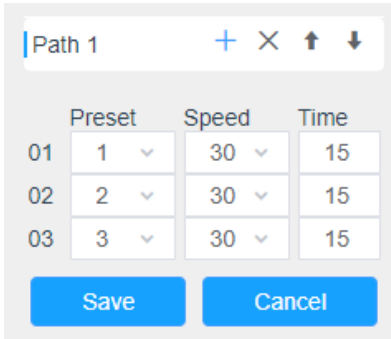

	Preset	Speed	Time
01	1	30	15
02	2	30	15
03	3	30	15

Step4: Configure the preset number, patrol speed and patrol time;

Table 74. Description of Patrol Settings

Name	Description
Patrol Speed	The speed of moving from one preset to another.
Patrol Time	The duration staying on one patrol point. The PTZ camera moves to another patrol point after the set patrol time.

Step5: Click  to save the patrol settings.

 **Note:**

- Patrol Speed only works in Patrol mode.
- Patrol Time should be 15~120s for PTZ Bullet and 0~120s for Speed Dome.

Call a patrol:

In the PTZ control panel, select a defined patrol from the patrol list, and click  to call the patrol, as shown below.

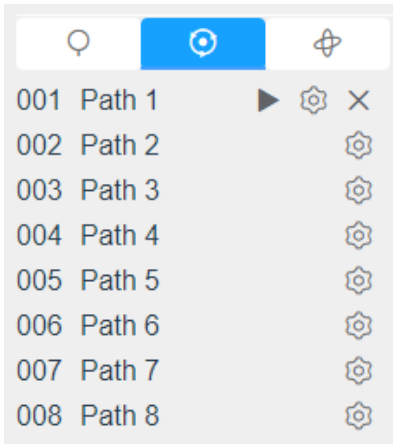

Note: The three buttons behind the Patrol list means: Play, Set and Delete.

Set / Call a pattern

A pattern is a memorized series of pan, tilt, zoom and preset functions. It can be called on the pattern settings interface. There are up to 4 patterns can be set.

Set a pattern:

Step1: In the PTZ control panel, click  to enter the pattern settings interface;

Step2: Select a pattern number from the pattern list as shown in the figure below;

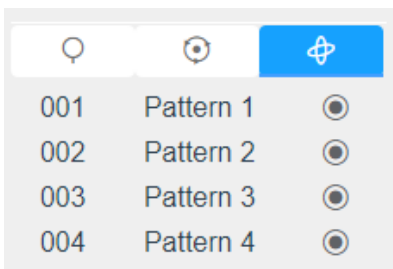

Step3: Click  to activate recording the panning, tilting and zooming actions;

Step4: Use the PTZ controller buttons to move the lens to the interested position;

Step5: Click  to save all the pattern settings.

Note: The percentage of number on the OSD is the remaining space of pattern. Start with 100% and run out of 0%.

Call a pattern:

In the PTZ control panel, select a defined pattern from the pattern list, click  to call the pattern, as shown in the figure below.

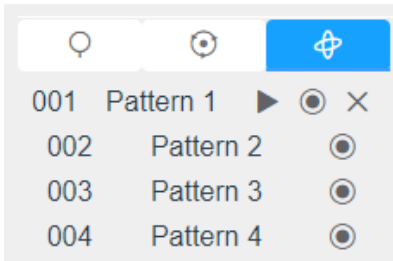

Note:

The three button behind the Pattern list means: Play, Record and Delete.

When configuring the pattern, pan and tilt are valid but the limit stops and auto flip will be invalid. Also, 3D Positioning operation is not supported.

LPR Mode

Milesight LPR Camera supports professional LPR Live View interface , it can show the real-time license plate recognition results and display the snapshots of detected license plates ,which realizes a stand-alone LPR solution.

After logging in the LPR network camera web GUI successfully, users can click to access the LPR Mode page, which is shown as follows.

The screenshot shows the Milesight Network Camera LPR Mode interface. It features a live video feed of a road with several vehicles. A blue bounding box highlights a car, and a 'Region' label is visible. Below the video feed, there is a table of license plate recognition results. The table has the following columns: No., License Plate, Snapshot, Plate Type, Plate Color, Vehicle Type, Vehicle Color, Speed, Direction, Detection Region, Time, and Operation. The current recognition result is AA802TN, a white visitor car moving at 113km/h.

No.	License Plate	Snapshot	Plate Type	Plate Color	Vehicle Type	Vehicle Color	Speed	Direction	Detection Region	Time	Operation
11	AA50		Visitor	White	Car	White	113km/h	↓ Approach	1	2022-11-22 08:55:31	
10	AB0K		Visitor	White	SUV	Black	77km/h	↓ Approach	1	2022-11-22 08:55:29	
9	AJ		Visitor	White	SUV	Black	74km/h	↓ Approach	2	2022-11-22 08:55:25	
8	AE		Visitor	White	SUV	White	81km/h	↓ Approach	2	2022-11-22 08:55:24	
7	AB		Visitor	White	Car	Black	81km/h	↓ Approach	2	2022-11-22 08:55:23	
6	A		Visitor	White	Truck	Yellow	62km/h	↓ Approach	1	2022-11-22 08:55:23	
5	AS		Visitor	White	Car	Black	78km/h	↓ Approach	1	2022-11-22 08:55:23	
4	AA		Visitor	White	SUV	Black	148km/h	↓ Approach	1	2022-11-22 08:55:17	

Left Panel: Live View interface of LPR cameras.

Right Panel: Snapshots of the real-time vehicle and display the information of the vehicle according to the snapshot.

Bottom Panel: Display the information of the vehicles recently detected.

 **Note:**

- The Speed can only be detected by Radar LPR network cameras.
- Vehicles without license plates will be detected and captured by the cameras in real-time, and the recognition results will be recorded as "No Plates".

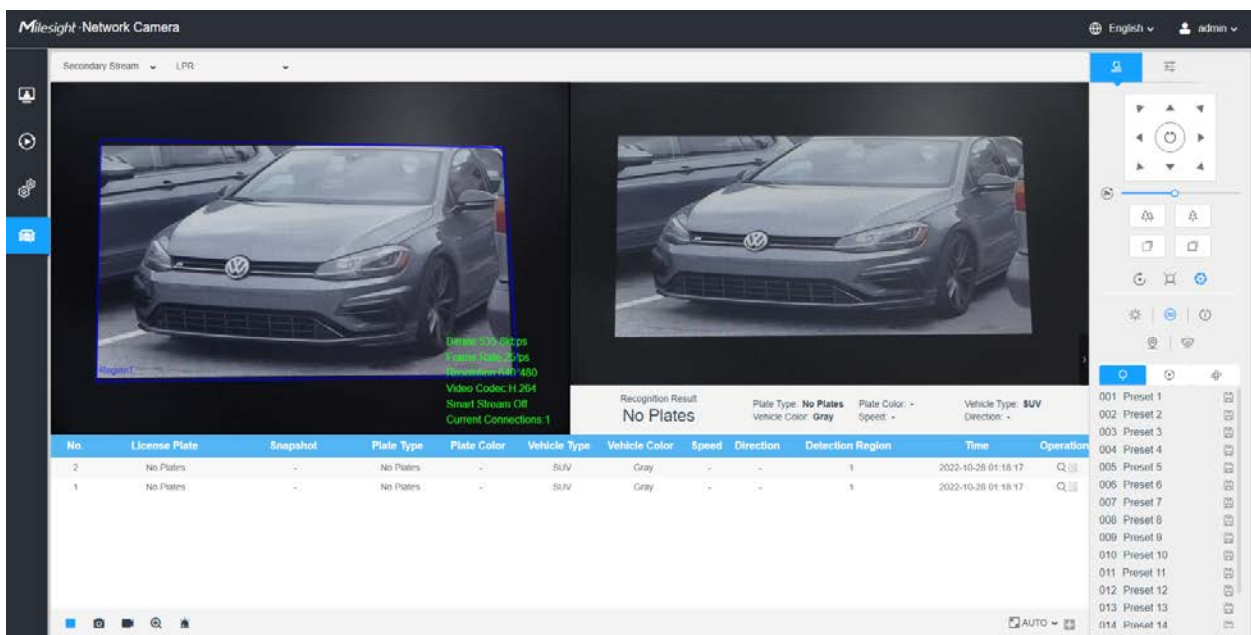



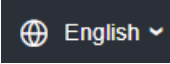
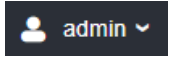
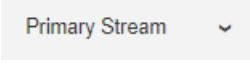

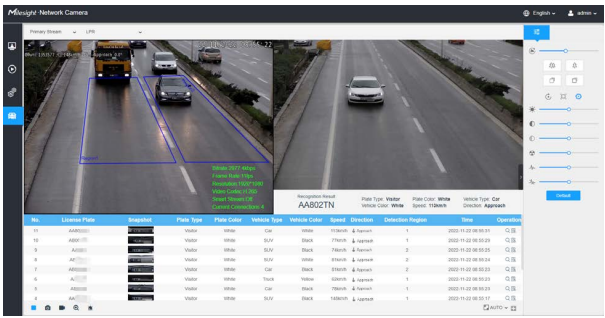







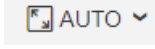



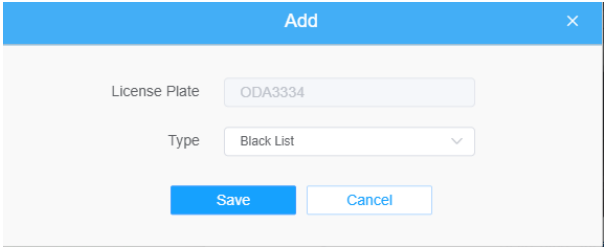

Table 75. Description of the buttons

	Parameter	Description
1	 Live Video	Click to access the live view page.
2	 Playback	Click to access the playback page.

	Parameter	Description
3	 Settings	Click to access the configuration page.
4	 LPR Mode	Click to access the LPR Mode page.
5		Click to select system language.
6		Display the user name and click to logout.
7		Choose the Stream (Primary/Secondary/Tertiary) to show on the current video window.
8		Choose the options (Hide Detection Region/LPR) to hide/show detection region on the current video window. 
9	 Stop/Play	Stop/Play live view.
10	 Alarm	When the Black List license plates passing by, the icon appears.
11	 Alarm	When the White List license plates passing by, the icon appears.

	Parameter	Description
12	 Alarm	When the Visitor license plates passing by, the icon appears.
13	 Snapshot	Click to capture the current image and save to the configured path. The default path is: C:\VMS\+-1\ IMAGE-MANUAL.
14	 Start/Stop Recording	Click to Start Recording video and save to the configured path. Click again to stop recording. The default path is C:\VMS\+-1\MS_Record. Click again to Stop Recording .
15	 Digital Zoom	When enabled, you can zoom in a specific area of video image with your mouse wheel.
16	 Manual Output	Manually trigger Camera Alarm Output.
17	 Window Size	Click to display images at a window size.
18	 Full Screen	Click to display images at full-screen.
Operation		Click to view selected license plate with a large picture.
Operation		<p>Click to add the selected license plate to White/Black List.</p> 

3.6 Playback

Playback

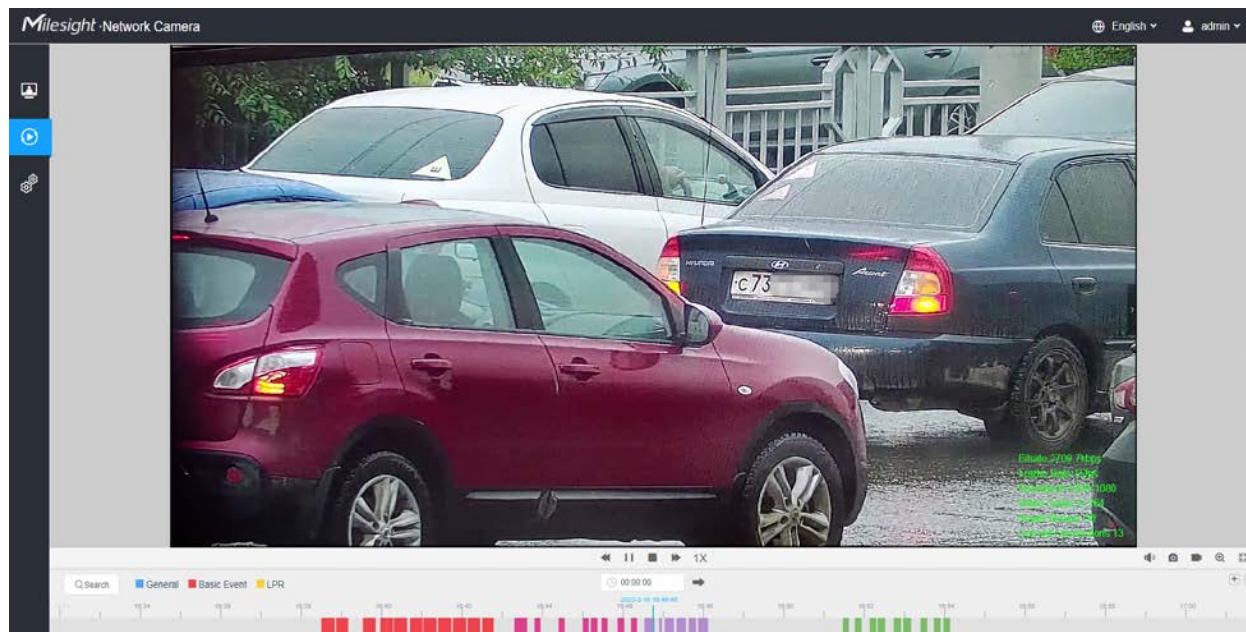

Click  to enter playback interface. In this part, you can search and playback the recorded video files stored in SD cards or NAS. The Playback interface is as below:

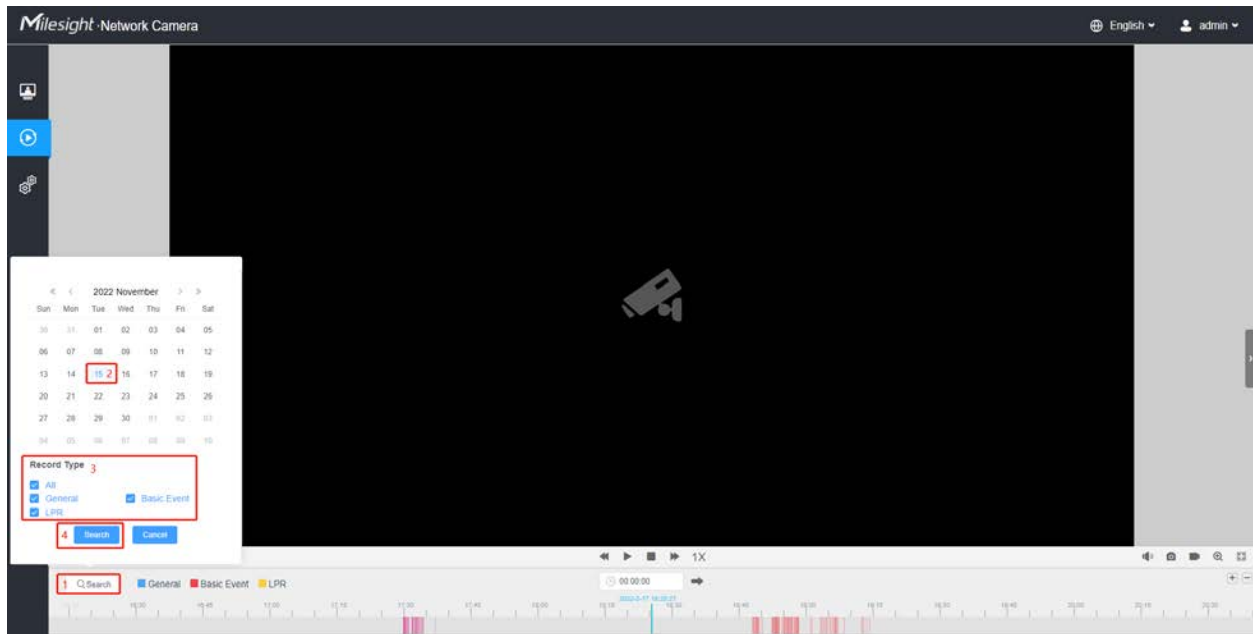

Step1: Click the “Search” button, choose the data and record type when the window pops up.



Step2: The timeline displays the video files for the day and show different colors according to selected record type. Drag the progress bar with the mouse to locate the exact playback point as needed.

Note: You can also input the time and click  to locate the playback point in the filed. You can also click   to zoom out/in the progress bar.

Step3: Click  to play the video files found on this date. The toolbar on the bottom of playback interface can be used to control playing progress.

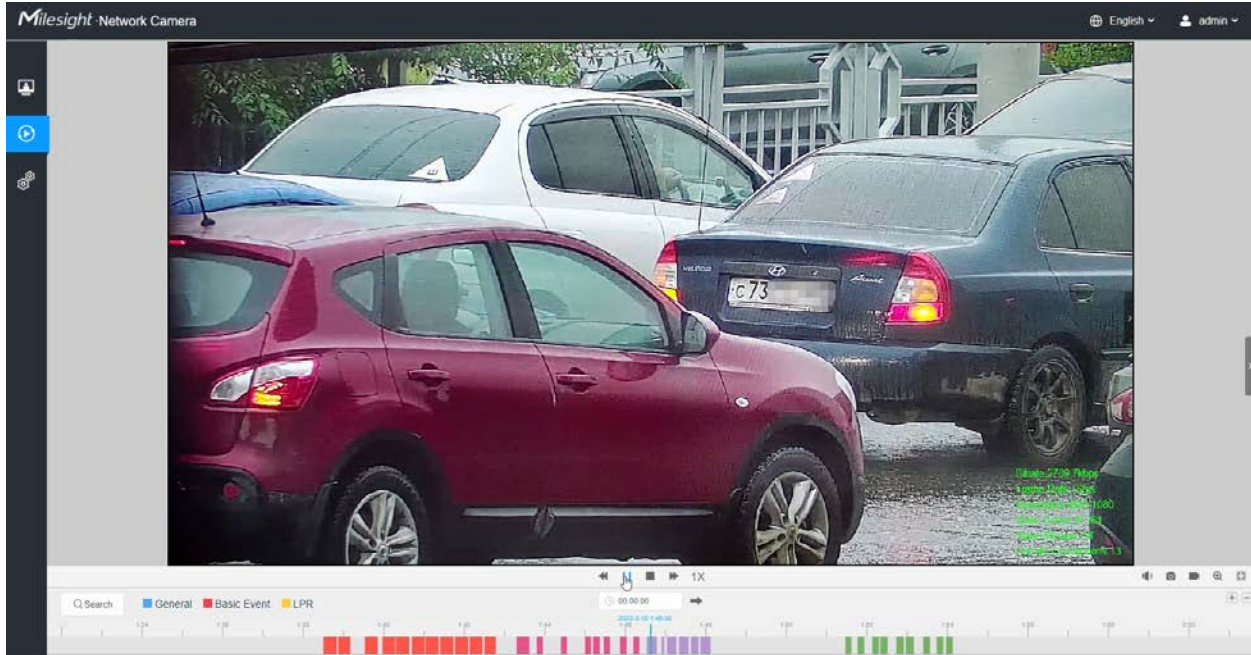

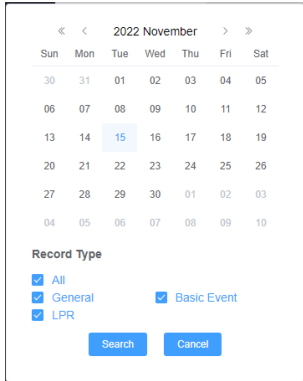
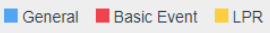



Table 76. Description of the buttons

No.	Parameter	Description
		<p>For LPR camera, the record type include All/General/Basic Event/LPR. The timeline will show different colors according to selected record type as below:</p> 
1	 <p>Speed Down/Speed Up/Speed</p>	<p>Adjust the speed of video playback.</p> <p>Speed Down: Includes 0.5X and 0.25X for Play.</p> <p>Speed Up: Includes 2X and 4X for Play.</p> <p>Speed: The default playback speed is 1X</p>
2	 <p>Play/Pause</p>	<p>Play/Pause the video.</p>







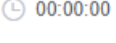

No.	Parameter	Description
3	 Stop	Stop the video.
4	 Search Time	Select the time that want to locate.
5	 Jump	Go To.

Table 77. Description of the buttons

No.	Parameter	Description
1	 Mute	Click to enable the audio.
2	 Snapshot	Click to take a snapshot.
3	 Start/Stop recording	Click to start/stop recording.
4	 Digital Zoom	Click to zoom on/off .
5	 Full Screen	Full Screen.
6	 Time Expand/Narrow	Time narrow/expand.

3.7 Settings

3.7.1 Media

Video

Stream parameters can be set in this module, adapting to different network environments and demands.

Primary Stream Settings

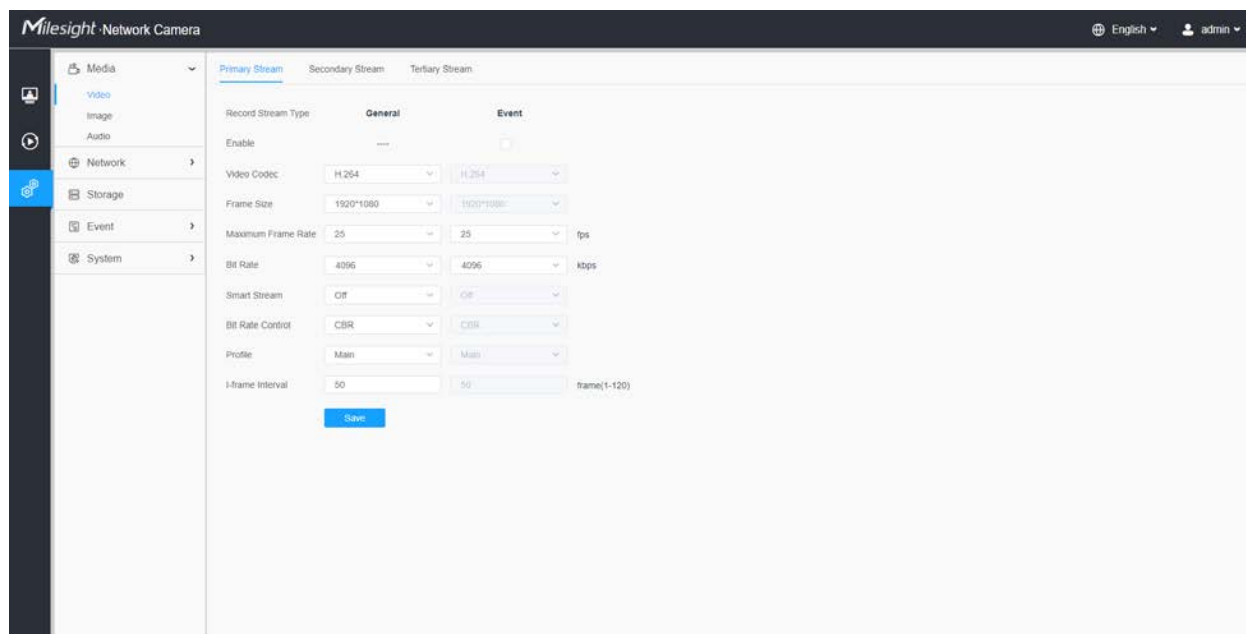

The screenshot displays the 'Mlesight Network Camera' web interface. The top navigation bar includes the logo, language selection (English), and user information (admin). A left sidebar contains menu items: Media (Video, Image, Audio), Network, Storage, Event, and System. The main content area is titled 'Primary Stream' and is divided into 'General' and 'Event' tabs. The 'General' tab is active, showing the following settings:

Record Stream Type	General	Event
Enable	<input type="checkbox"/>	<input type="checkbox"/>
Video Codec	H.264	H.264
Frame Size	1920*1080	1920*1080
Maximum Frame Rate	25	25
Bit Rate	4096	4096
Smart Stream	Off	Off
Bit Rate Control	CBR	CBR
Profile	Main	Main
I-frame Interval	50	50

A 'Save' button is located at the bottom of the settings panel.

Secondary Stream Settings

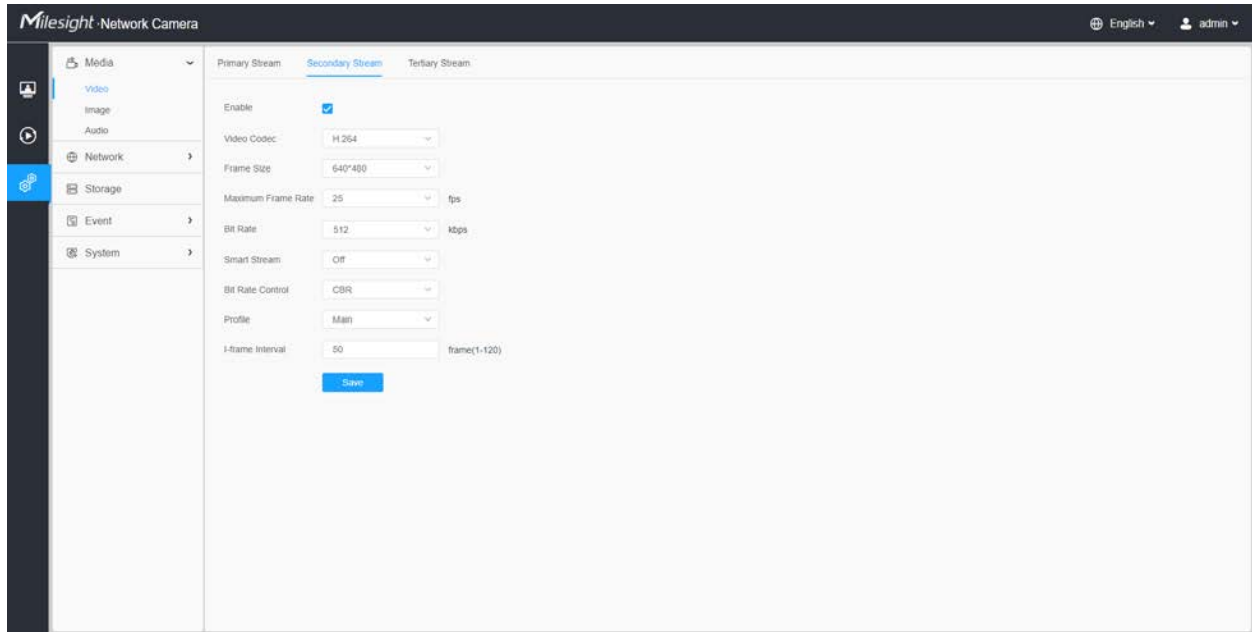

Tertiary Stream Settings

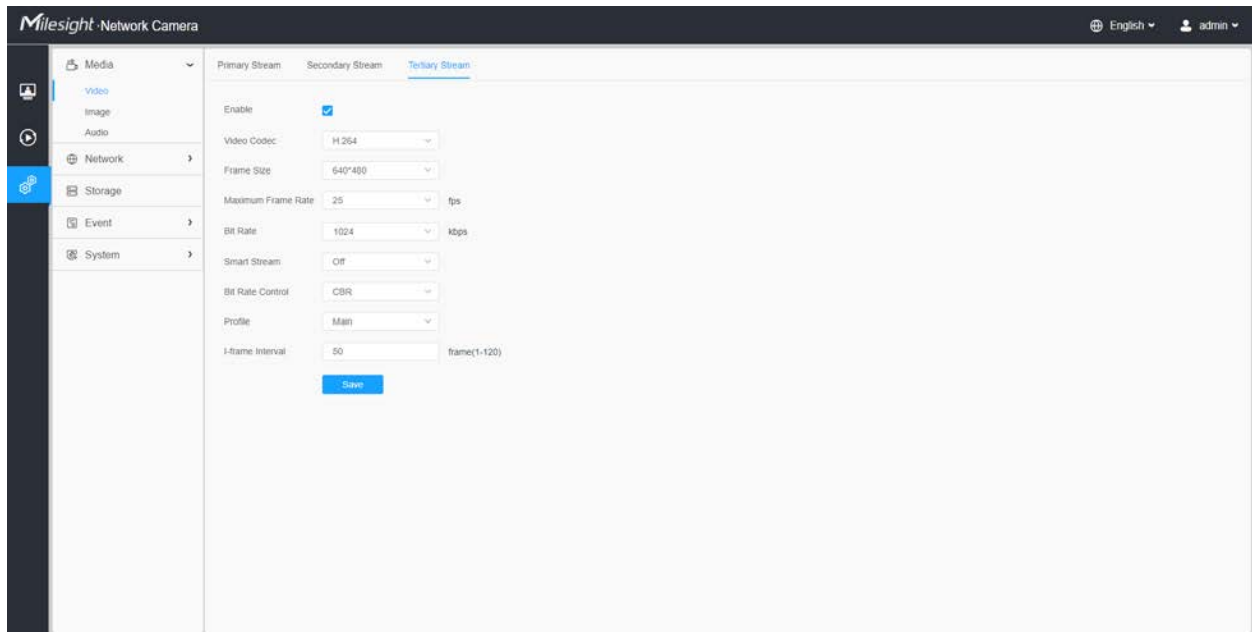



Table 78. Description of the buttons

Parameters	Function Introduction
Record Stream Type	<p>General & Event are available only for Primary Stream. General refers to continuous record video, while Event includes events that can trigger alarms, such as Motion, Exception, LPR and so on.</p> <p>This item can separately set different bit rate and frame rate for different Recording Stream Types. If user chooses Event, video will be recorded according to the configuration of video stream type when an event happens, thereby greatly reducing the recording storage space.</p>
Enable Event Stream	This item is optional only if you selected the Event.
Video Codec	H.265/H.264/MJPEG are available.
Frame Size	<p>Options include 8M(3840×2160), 6M(3072×2048), 5M(2592*1944), 5M(2560*1920), 5M(2560*1440), 4M(2592*1520), 3M(2304*1296), 3M(2048*1536), 1080P(1920*1080), 2M(1600 *1200), 1.3M(1280*960), 720P(1280*720), D1(704*576).</p> <p>For Secondary Stream, it includes 704*576, 640*480, 640*360, 352*288, 320*240, 320*192, 320*176.</p> <p>For Tertiary Stream, it include 1920*1080, 1280*720, 704*576, 640*480, 640*360, 352*288, 320*240, 320*192, 320*176.</p> <p> Note: The options of Frame Size are variable according to the model.</p>
Maximum Frame Rate	Maximum refresh frame rate of per second and it is variable according to the mode.
Bit Rate	<p>Transmitting bits of data per second, this item is optional only if you select the H.265/H.264</p> <p>Set the bitrate to 16~16384 Kbps. The higher value corresponds to the higher video quality, and the higher bandwidth is required as well.</p>
Smart Stream	<p>Optional to turn On/Off Smart Stream mode. Smart Stream mode remarkably reduces the bandwidth and the data storage requirements for network cameras while ensuring the high quality of images, and it is a 10-level adjustable codec.</p> <p>Level: Level 1~10 are available as needed.</p>
Bit Rate Control	CBR: Constant Bitrate. The rate of CBR output is constant.
Bit Rate Control	VBR: Variable Bitrate. VBR files vary the amount of output data per time segment.
Image Quality	Low/Medium/High are available, this item is optional only if you select VBR.

Parameters	Function Introduction
Profile	The option is for H.264, Main/High/Base can be selected as needed.
I-frame Interval	Set the I-frame interval to 1~120, 50 for the default. This item is optional only if you select the H.265/H.264. The number must be a multiple of the number of frames.

Image

General settings of image including the image adjustment, day/night setting and image enhancement can be set in this module. OSD (On Screen Display) content, privacy mask and video time can be displayed to rich the image information.

General

General settings of image including the Image Adjustment, White LED Light, Day/Night Switch, Day/Night Parameters, Exposure, Backlight, White Balance, Image Enhancement and Display can be set in this module.

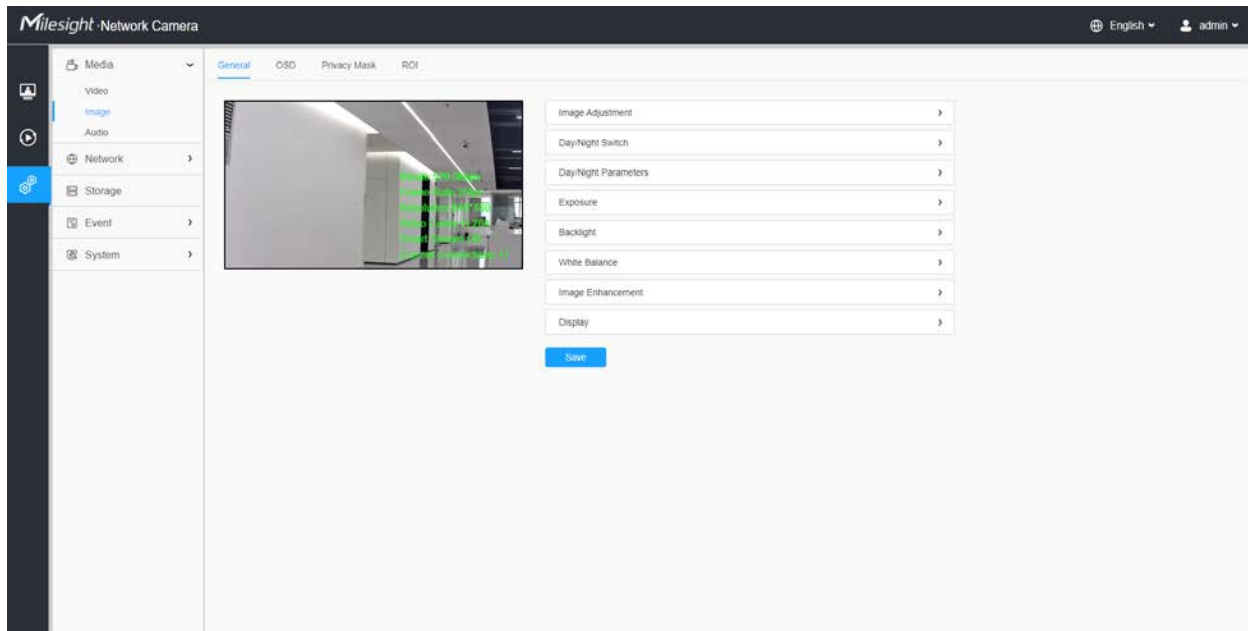

[Image Adjustment]

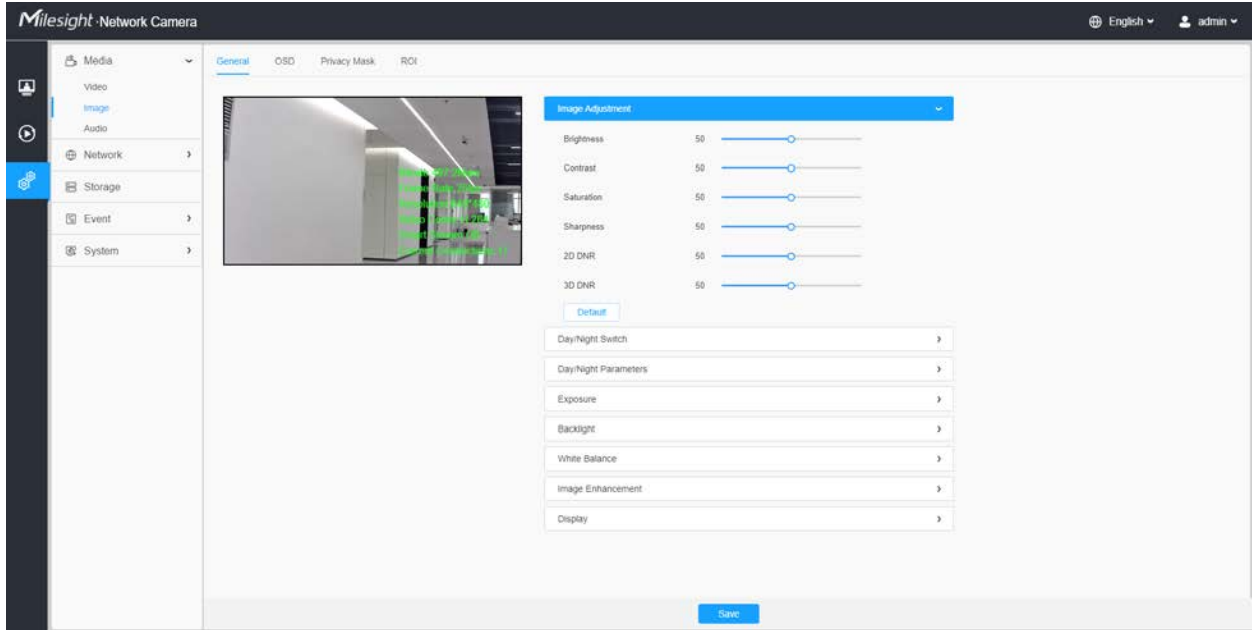
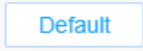

Table 79. Description of the buttons

Parameters	Function Introduction
Brightness	Adjust the Brightness of the scene.
Contrast	Adjust the color and light contrast.
Saturation	Adjust the Saturation of the image. Higher Saturation makes colors appear more "pure" while lower one appears more "wash-out".
Sharpness	Adjust the Sharpness of image. Higher Sharpness sharpens the pixel boundary and makes the image looks "more clear".
2D DNR	Adjust the noise reduction level.
3D DNR	Restore brightness, contrast and saturation to default settings.
	Click this button to restore to the default setting.

[White LED Light]

This option is used to control the White LED Light of the Supplement Light model. There are 4 options including Auto, Always On, Off and Customize are available.

Note:

- Make sure the camera model is a Supplement Light model with the White LED Light.
- White LED Light and IR Light can not be turned on at the same time.

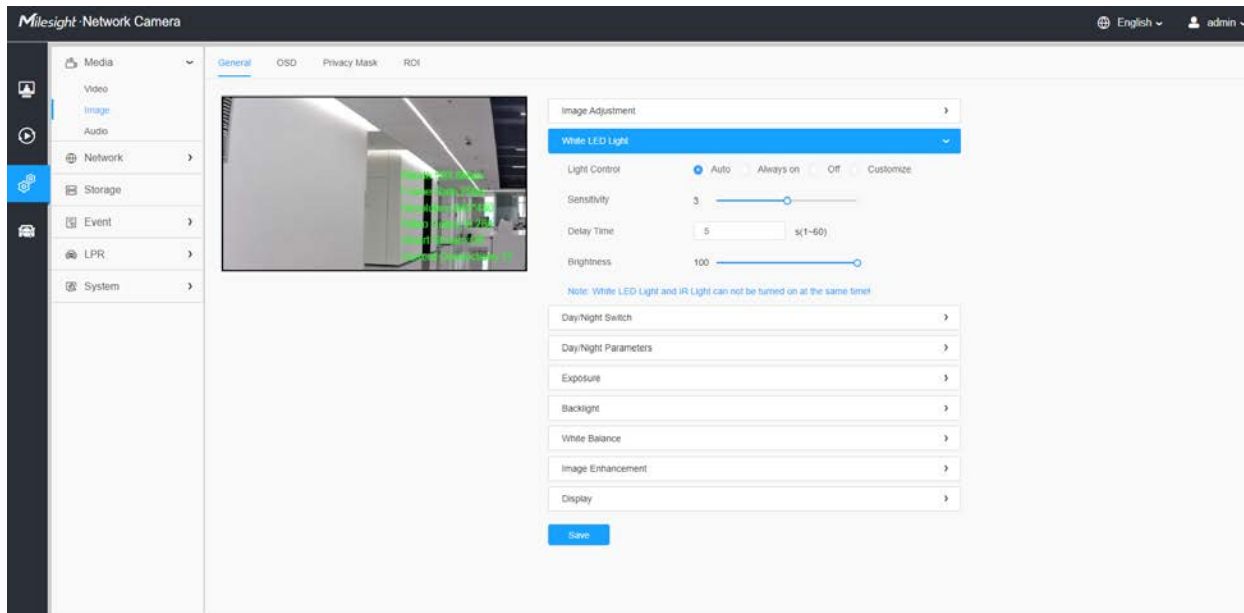



Table 80. Description of the options

Parameters		Function Introduction
Light Control	Auto	<p>Select this option to automatically control the White LED Light based on the image. You can customize the sensitivity and delay time.</p> <ul style="list-style-type: none"> • Sensitivity: This option is to adjust the sensitivity of the White LED Light, level 1~5 are available, and the default level is 3. The higher the sensitivity, the easier it is to switch the White LED Light status according to image light changes. For example, when the sensitivity is set to level 5, it will turn on the White LED Light when the light in the environment is not very dark. • Delay Time: This option is to avoid the White LED Light status changes due to sudden light changes in the environment. The longer the delay time, the longer the response time for the White LED Light to turn on and off. 1~60s are available, and the default option is 5s. For example, here I set the delay time to 5 seconds, if the image suddenly brightens due to a passing car with its headlights on, the white LED light will not be turned off immediately.
	Always On	Select this option to keep the White LED Light always on.
	Off	Select this option to keep the White LED Light always off.

Parameters		Function Introduction
	Customize	<p>Select this option to customize the Start Time and End Time of the White LED Light.</p> 
Brightness		Users can customize the brightness, levels 1-100 are available, the higher the level, the brighter the White LED Light.



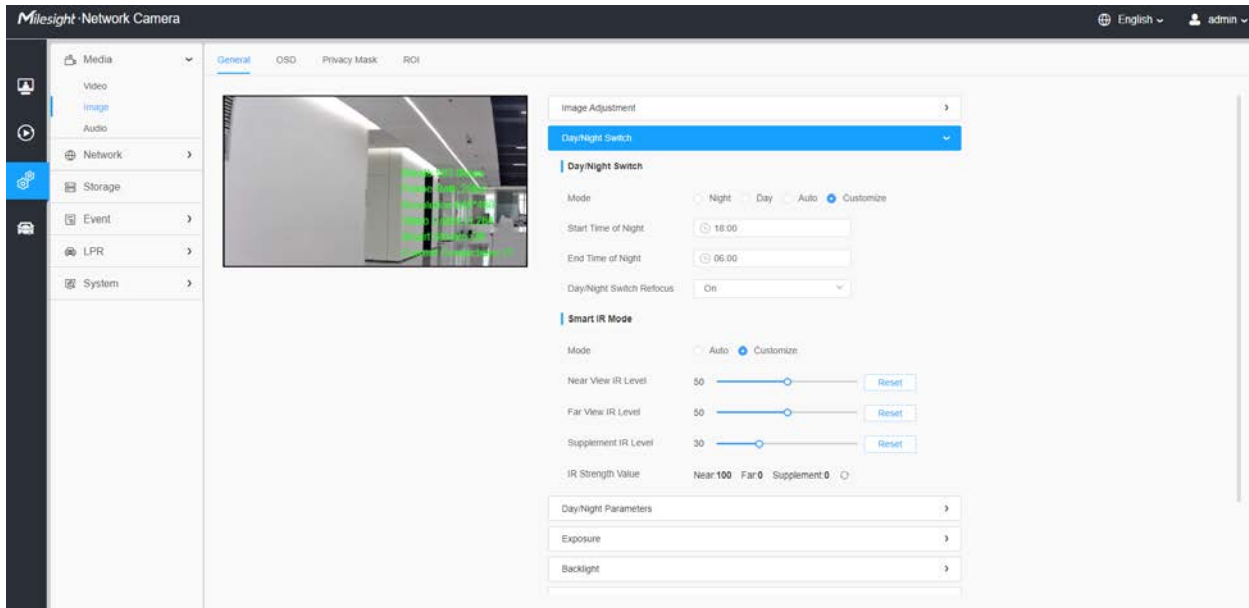

[Day/Night Switch]

This option is used to control the Day/Night mode. And we applied **Smart IR II Technology** on the camera. It combines the High Beam and Low Beam, upgrading the IR LEDs technology to provide better image clarity and quality regardless of the object distance. Also, the Low Beam and High Beam's brightness can be adjusted manually or automatically on the basis of the Zoom ratio. Moreover, with the IR anti-reflection panel, the infrared light transmittance is highly increased.



There are 4 modes for Day/Night Switch, including Night, Day, Auto and Customize.

Table 81. Description of the options

Parameters		Function Introduction
Day/Night Switch	Night	Switch to Night Mode according to the parameters of night mode.  Note: There are several parameters such as Exposure Level, Maximum Exposure Time and IR-CUT Interval, etc, associated with the mode.
	Day	Switch to Day Mode according to the parameters of day mode.  Note: There are several parameters such as Exposure Level, Maximum Exposure Time and IR-CUT Interval, etc, associated with the mode.
	Auto	Select this option to automatically switch the Day/Night Mode based on the image. <ul style="list-style-type: none"> • Day to Night Value: You can set the sensitivity for switching Day Mode to Night Mode. When IR Light Sensor Current Value is lower than this value, it will switch Day Mode to Night Mode. You can click  to reset the value to 36. • Night to Day Value: This is the sensitivity for switching Night Mode to Day Mode. When IR Light Sensor Current Value is higher than this value, it will switch Night Mode to Day Mode. You can click  to reset the value to 82. • IR Light Sensor Value: The current value of the IR light sensor.
	Customize	Select this option to customize the Start Time and End Time of Night. <ul style="list-style-type: none"> • Start Time of Night: You can set the time to start the Night Mode. • End Time of Night: You can set the time to start the Day Mode.
	Day/Night Switch Refocus	With this option enabled, the camera will refocus when switching between day mode and night mode.

There are 2 modes for Smart IR Mode to achieve the best effect, including Auto and Customize.

Table 82. Description of the buttons

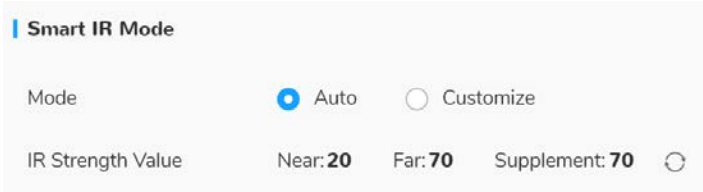
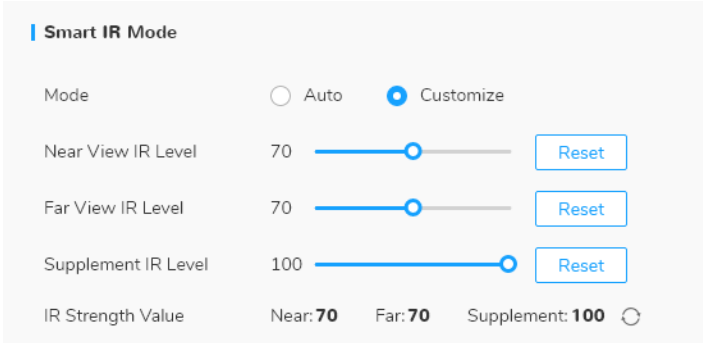
Parameters		Function Introduction
Smart IR Mode	Auto	<p>Select this option to automatically adjust the strength of the Low-Beams LED, High-Beams LED and IR LED Supplement Light on the basis of the Zoom ratio.</p>  <p>Note:</p> <ul style="list-style-type: none"> • In Auto Mode, the strength of the IR Supplement Light will be the same as that of the High-Beams LED. • For the IR LRD Supplement Light function, make sure the camera model is a Supplement Light model with the IR LED Light.
	Customize	<p>Select this option to manually adjust the strength of the Low-Beams LED, High-Beams LED and IR LED Supplement Light. You can see the effect of these LEDs in the image in real-time as you adjust the strength, and you can also click Reset to reset the light strength.</p> <ul style="list-style-type: none"> • Near View IR Level: Adjust the light strength of Low-Beams LED light level from 0 to 100. • Far View IR Level: Adjust the light strength of High-Beams LED light level from 0 to 100. • Supplement IR Level: Adjust the strength of IR Supplement Light from 0 to 100. • IR Strength Value: Show the current value of Low-Beams LED, High-Beams LED and IR LED Supplement Light value.  <p>Note: For the video demo of the supplement light, you can refer to:</p> <ul style="list-style-type: none"> • IR LED Supplement Light: https://youtu.be/YVTVR88V0Rg • White LED Supplement Light: https://youtu.be/wn18oEzY5yk

[Day/Night Parameters]

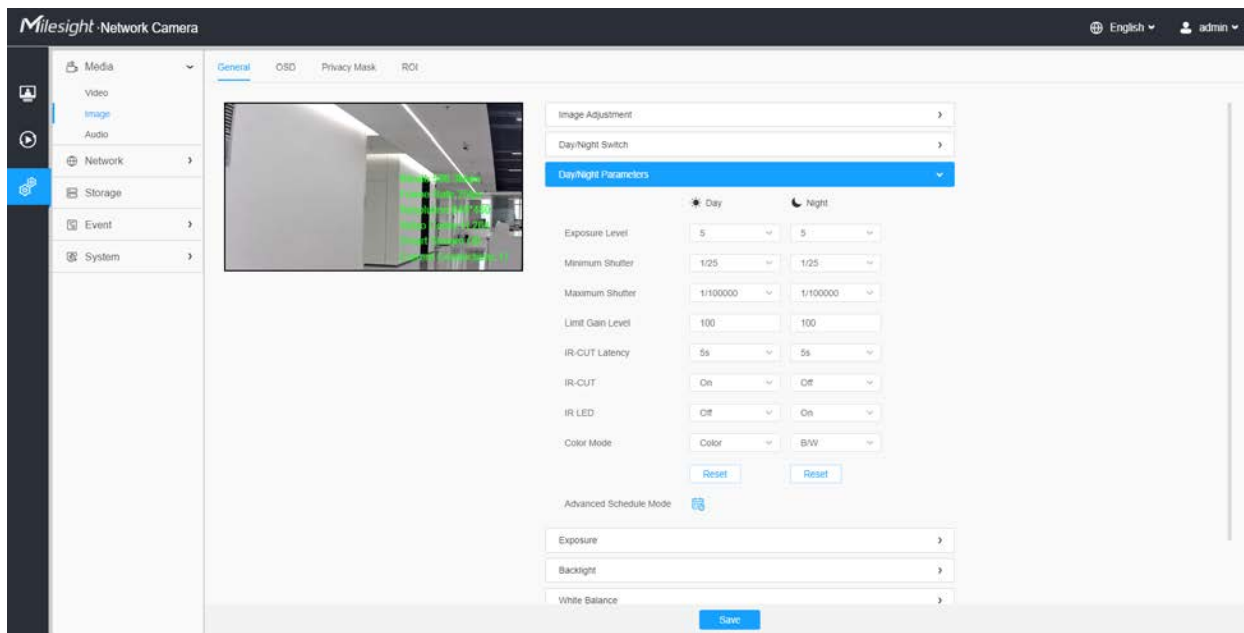

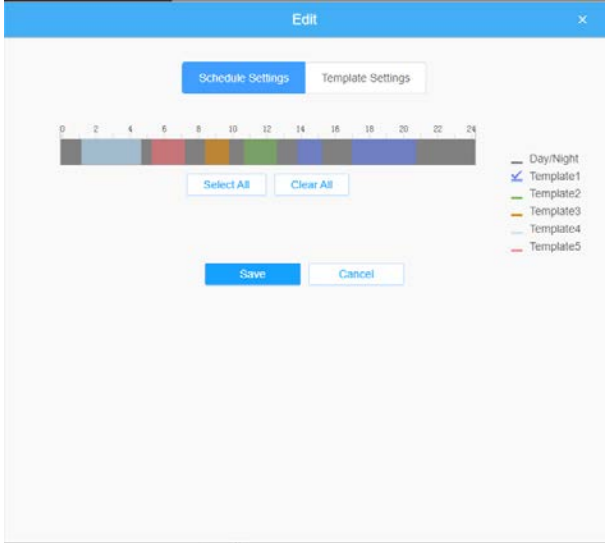

Table 83. Description of the buttons

Parameters	Function Introduction
Exposure Level	Level 0~10 are available to meet your need.
Minimum Shutter	Minimum Shutter is the same as Maximum Exposure Time. Set the minimum Shutter to 1~1/100000s.
Maximum Shutter	Maximum Shutter is the same as Minimum Exposure Time. Set the maximum Shutter to 1~1/100000s.
IR-CUT Latency	The interval time of switching one mode to another.
Limit Gain Level	Set the Limit Gain Level to 1~100.
IR-CUT	Turn on/off IR-CUT.
IR LED	Turn on/off IR-LED.
Color Mode	Select B/W or Color mode.

Parameters	Function Introduction
<div style="text-align: center;">  <p>Advanced Schedule Mode</p> </div>	<p>Here you can customize your special demands for different time, then the Day mode and Night mode will switch automatically according to your settings.</p> 

[Exposure]

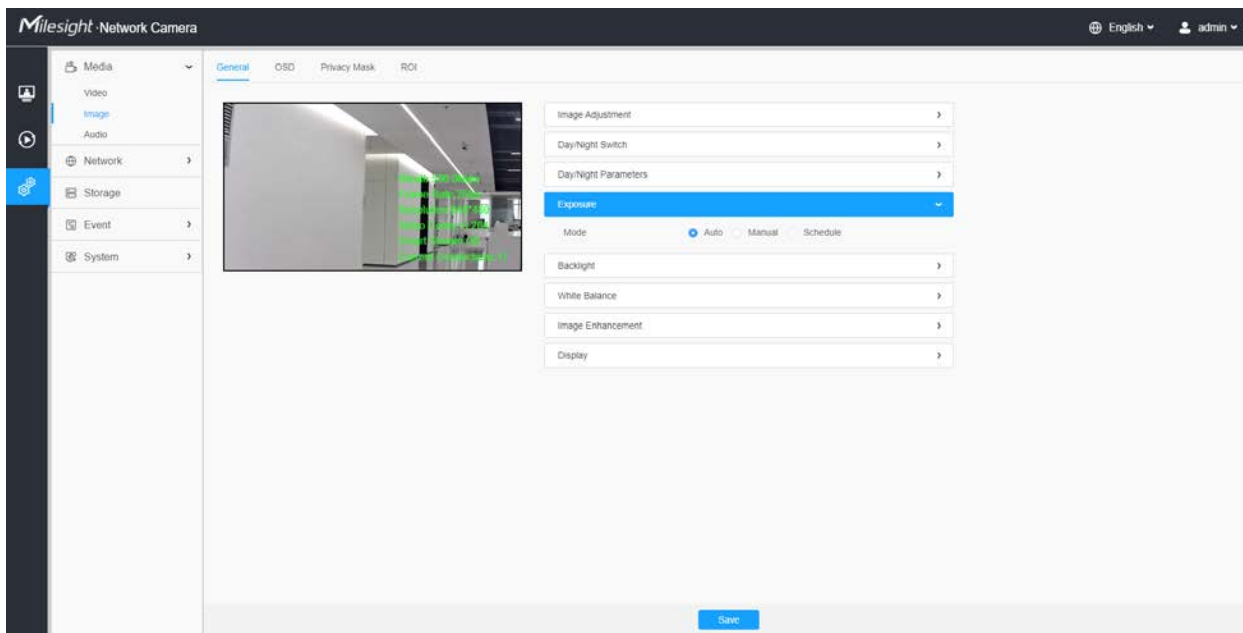
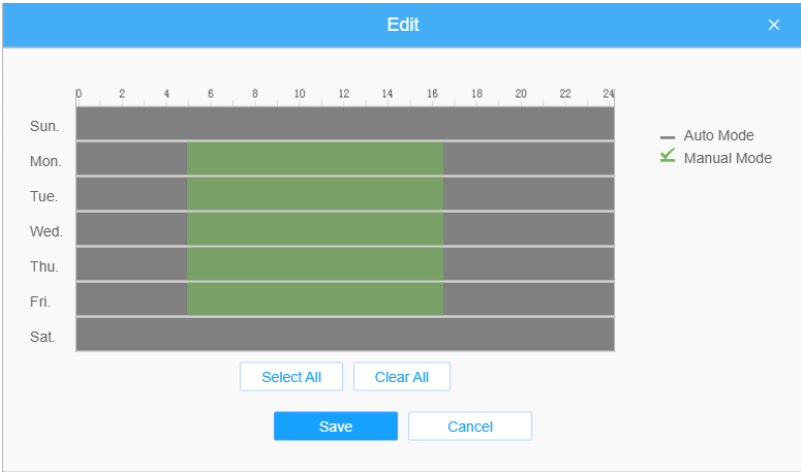

Table 84. Description of the buttons

Parameters	Function Introduction
<p style="text-align: center;">Exposure Mode</p>	<p>Auto Mode, Manual Mode and Schedule Mode are available.</p> <p>Auto Mode: The camera will adjust the brightness according to the light environment automatically.</p> <p>Manual Mode: The camera will adjust the brightness according to the value you set, you can set the exposure time from 1~1/100000s, the higher the value is, the brighter the image is.</p> <p>Schedule Mode: You can customize the schedule to enable/disable Auto Mode and Manual Mode.</p> 

[Backlight]

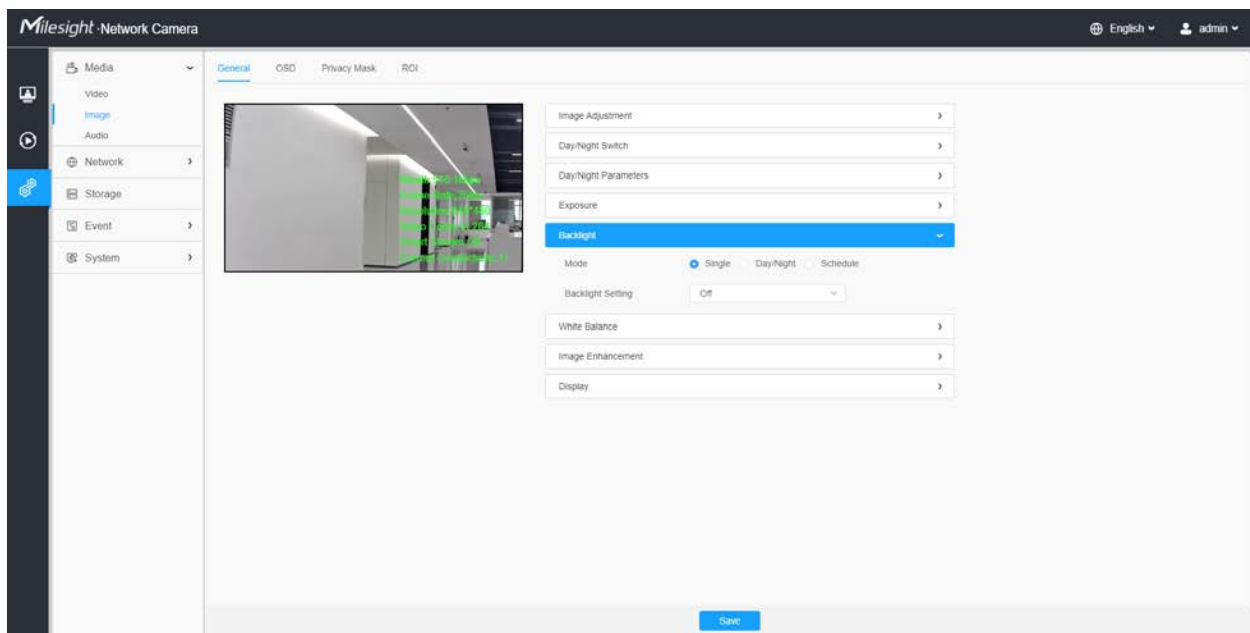

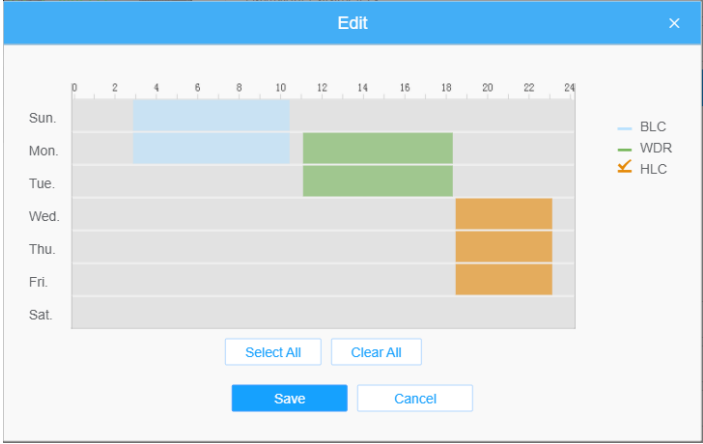

Table 85. Description of the buttons

Parameters	Function Introduction
<p style="text-align: center;">Backlight Mode</p>	<p>Single Mode: Set single mode for BLC/WDR/HLC.</p> <p> Note: Do not support WDR and General HLC while High Frame Rate is enabled.</p> <p>Day/Night Mode: Support BLC/WDR/HLC on Day Enhancement Mode/Night Enhancement Mode separately.</p> <p>Schedule Mode: Set schedule mode for BLC/WDR/HLC. You can customize the schedule to enable/disable BLC/WDR/HLC mode.</p> 

 **Note:**

- For more details about **Milesight WDR on & off Video**, you can click to the YouTube:
<https://www.youtube.com/watch?v=McoOL0Pyk0w>
- For more details about **Milesight Ultra Low-light Video Demo - HLC**, you can click to the YouTube:
<https://www.youtube.com/watch?v=ly8uKWbii40>
- For more details about **Milesight Super WDR Pro**, you can click to the YouTube:
<https://www.youtube.com/watch?v=edsPZXBjRnl>
- For more details about **Milesight Super WDR Performance**, you can click to the YouTube:
<https://www.youtube.com/watch?v=BKEZ6BW-YZE>

[White Balance]

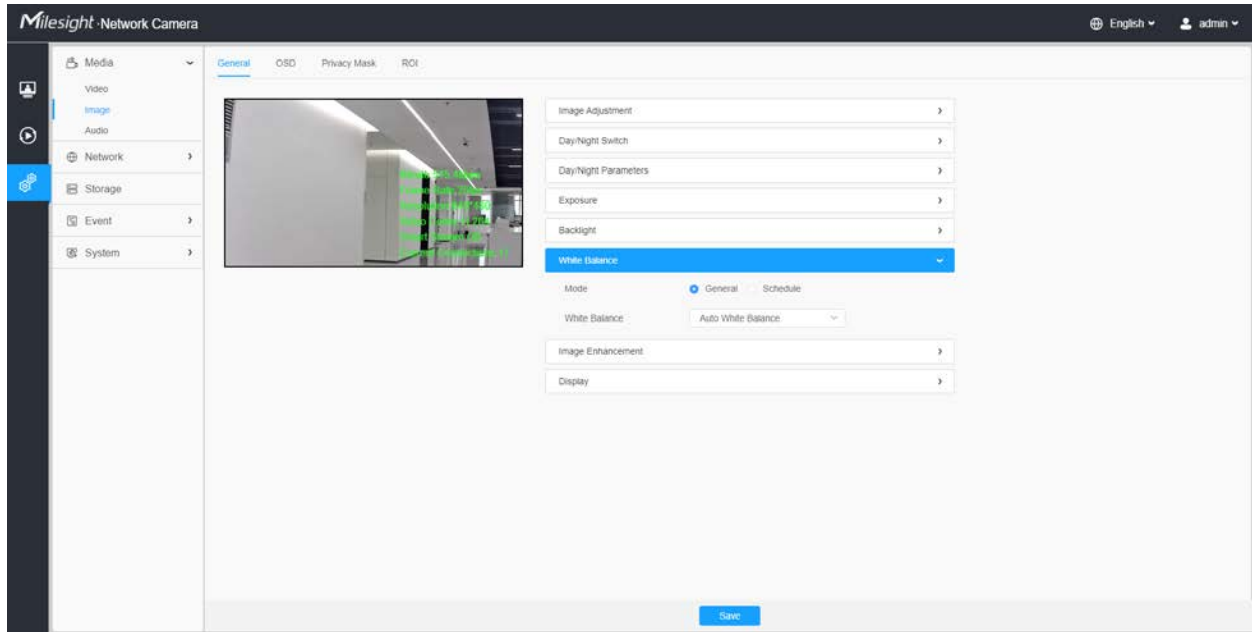
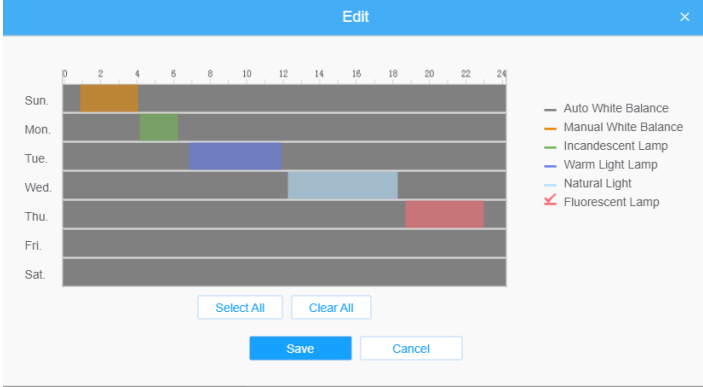

Table 86. Description of the buttons

Parameters	Function Introduction
<p>White Balance</p>	<p>To restore white objects, removed color distortion caused by the light of the environment.</p> <p>Mode: General and Schedule are available.</p> <hr/> <p>General Mode: Select a white balance mode as required</p> <ul style="list-style-type: none"> • Auto White Balance: This option will automatically enable the White Balance function. • Manual White Balance: Set Red Gain Level and Blue Gain Level manually. • Incandescent Lamp: Select this option when light is similar with incandescent lamp. • Warm Light Lamp: Select this option when light is similar with warm light lamp. • Natural Light: Select this option when there is no other light but natural light. • Fluorescent Lamp: Select this option when light is similar with Fluorescent Lamp.

Parameters	Function Introduction
	<p>Schedule Mode: Select this option that you can customize the schedule to enable/ disable above modes.</p> 

[Image Enhancement]

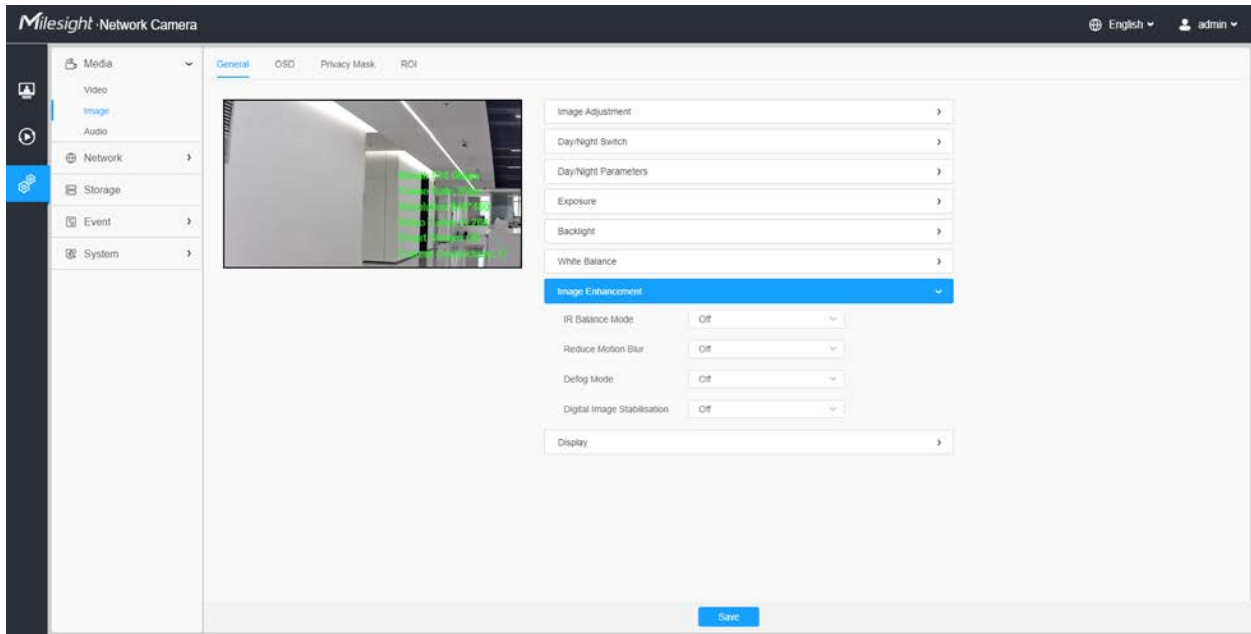



Table 87. Description of the buttons

Parameters	Function Introduction
<p>IR Balance Mode</p>	<p>There is an option to turn On/Off the IR LED.</p> <p>IR Balance Mode would avoid the problem of overexposure and darkness, and the IR LED will change according to the actual illumination.</p>

Parameters	Function Introduction
Reduce Motion Blur	<p>Enable this function to reduce the motion blur of objects effectively.</p> <p>You can adjust the deblur level from 1 to 100.</p> <p> Note: For more details about Milesight Deblur, you can click to the YouTube: https://www.youtube.com/watch?v=-vynrami51s</p>
Defog Mode	<p>Better image effect in foggy weather.</p> <p> Note:</p> <ul style="list-style-type: none"> For more details about Milesight Defog, you can click to the YouTube: https://www.youtube.com/watch?v=a9od7Trao4U
Digital Image Stabilisation	Decrease the blur and shakiness of the image.

[Display]

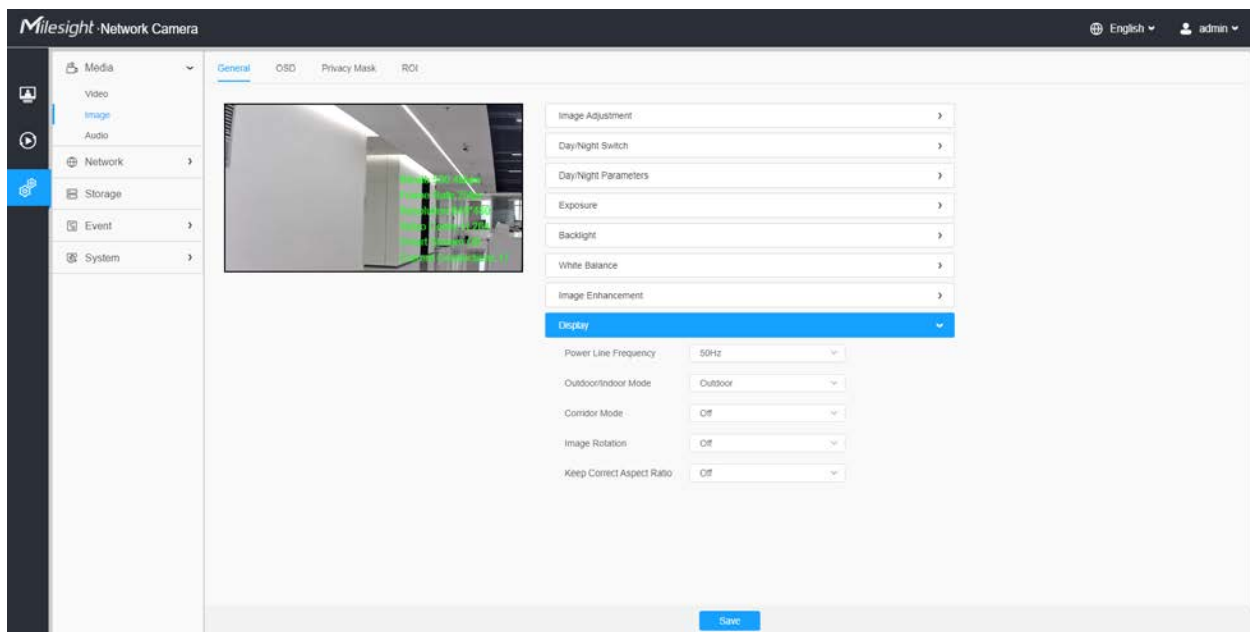





Table 88. Description of the buttons

Parameters	Function Introduction
Power Line Frequency	60Hz and 50Hz are available.
Outdoor/Indoor Mode	Select indoor or outdoor mode to meet your needs.

Parameters	Function Introduction
Corridor Mode	<p>There are three options available, you can select one to meet your need.</p> <p>Off: Keep the image in normal direction.</p> <p>Clockwise 90°: Rotate the image by 90° clockwise.</p> <p>Anticlockwise90°: Rotate the image by 90° anticlockwise.</p>
Image Rotation	<p>There are four options available, you can select one to meet your need.</p> <p>Off: Keep the image in normal direction.</p> <p>Rotating 180°: Upside down the image.</p> <p>Flip Horizontal: Flip the image horizontally.</p> <p>Flip vertical: Flip the image vertically.</p>
Keep Correct Aspect Ratio	<p>With this option enabled, the camera will prevent the image from distortion when resolution ratio is changed.</p>
Zoom Limit	<p>Set the Zoom Limit.</p> <p> Note: Only for the PTZ Network Camera with optical zoom of 20X or above.</p>
White LED Level	<p>Set the White LED Level to 1~100.</p> <p> Note: Only for PTZ Bullet.</p>
Smoked Dome Cover	<p>This function is only for Pro Dome. If Pro Dome is equipped with a Smoked Dome Cover, enable this function to display a normal image.</p> <p> Note: Only for Pro Dome.</p>

OSD

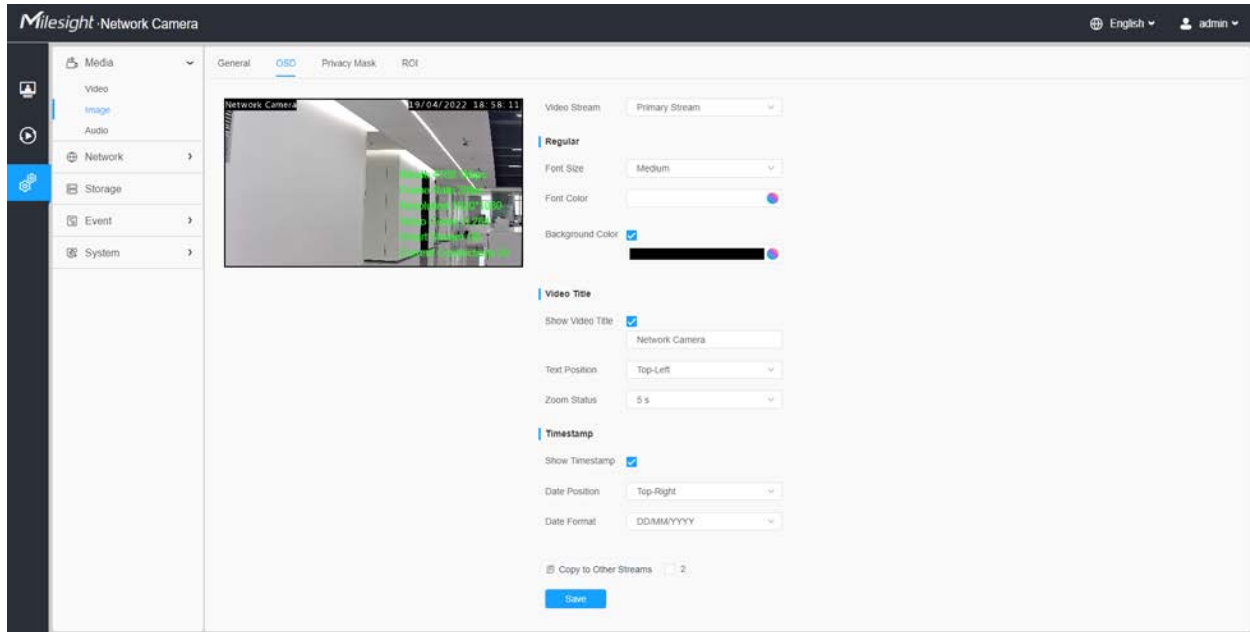



Table 89. Description of the buttons

Parameters	Function Introduction
Video Stream	Enable to set OSD for primary stream and secondary stream.
Font Size	Smallest/Small/Medium/Large/Largest/Auto are available for title and date.
Font Color	Enable to set different color for title and date.
Background Color	<p>Enable to set different colors for display information background on screen.</p> <p>You can set different colors for font and background of image , then the image OSD will show as below:</p> 
Show Video Title	Check the check box to show video title.
Video Title	Customize the OSD content.
Text Position	OSD display position on the image.
Show Timestamp	Check the checkbox to display date on the image.

Parameters	Function Introduction
Date Position	Date display position on the image.
Date Format	The format of date.
Copy to Other Streams	Copy the settings to other streams.

Privacy Mask

Privacy mask enables to cover certain areas on the live video to prevent certain spots in the surveillance area from being viewed and recorded.

You can select the color type and mosaic type to use for the cover certain areas on the live video. The mosaic type can maintain the continuity of the picture and improve the visual effect. Up to 28 mask areas are supported, which includes 24 mask areas and 4 mosaic areas.

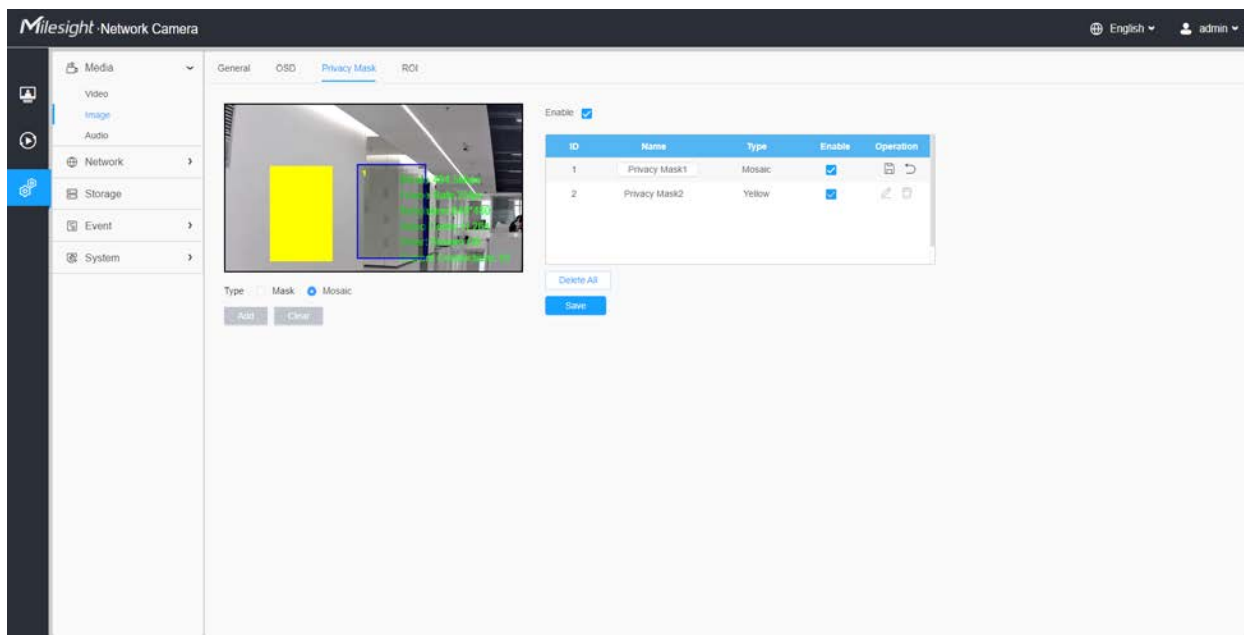
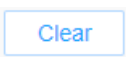





Table 90. Description of the buttons

Parameters	Function Introduction
Enable	Check the check box to enable the Privacy Mask function.
Type	Select the type to use for the privacy areas, there are two types available: Mask and Mosaic.
Add	Drew an privacy area on the live video as needed.

Parameters	Function Introduction	
	Clear the area you drew on the live video.	
Operation		Enable/disable the selected ROI areas.
		Change the color of Mask area, there are eight colors available: White, Black, Blue, Yellow, Green, Brown, Red and Purple
		Delete the privacy mask area

ROI

Region of interest (often abbreviate ROI), is a selected subset of samples within a dataset identified for a particular purpose. Users can select up to 8 key regions of a scene to transmit through separate streams for targeted preview and recording.

By using Milesight ROI technology, more than 50% of bit rate can be saved and therefore less bandwidth demanded and the storage usage reduced. So according to this, you can set a small bit rate for high resolution.

 **Note:** For more details about how to set ROI, please refer to <https://milesight.freshdesk.com/a/solutions/articles/69000643441>.

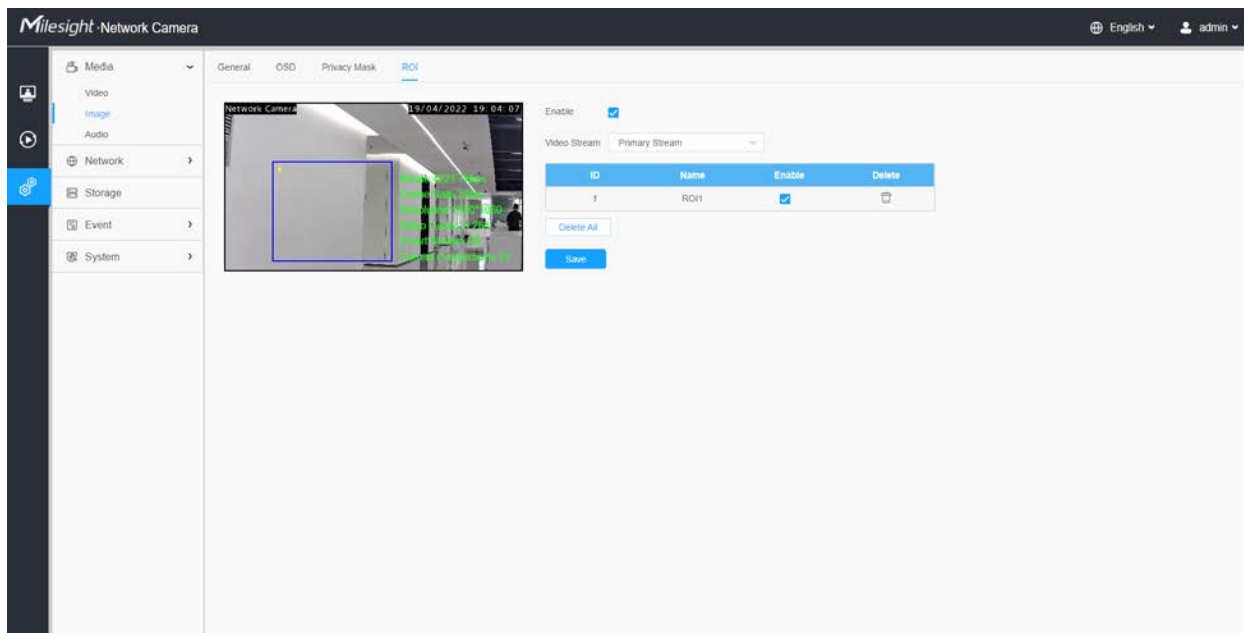



Table 91. Description of the buttons

Parameters	Function Introduction	
Enable	Check the checkbox to enable the ROI function.	
Video Stream	Choose the Video Stream.	
ROI		Enable/disable the selected ROI areas.
		Delete the selected ROI areas.
Delete All	Clear all areas you drew before.	

 **Note:**

- You can set a low bit rate. For example, you can set a bit rate with 512Kbps and a resolution with 1080P, then you can see the image quality of ROI is more clear and fluent than the other region.

Audio

Audio

This audio function allows you to hear the sound from the camera or transmit your sound to the camera side. A two-way communication is also possible to be achieved with this feature. Alarm can be triggered when the audio input is above a certain alarm level you set, and configured audio can be played when an alarm occurs.

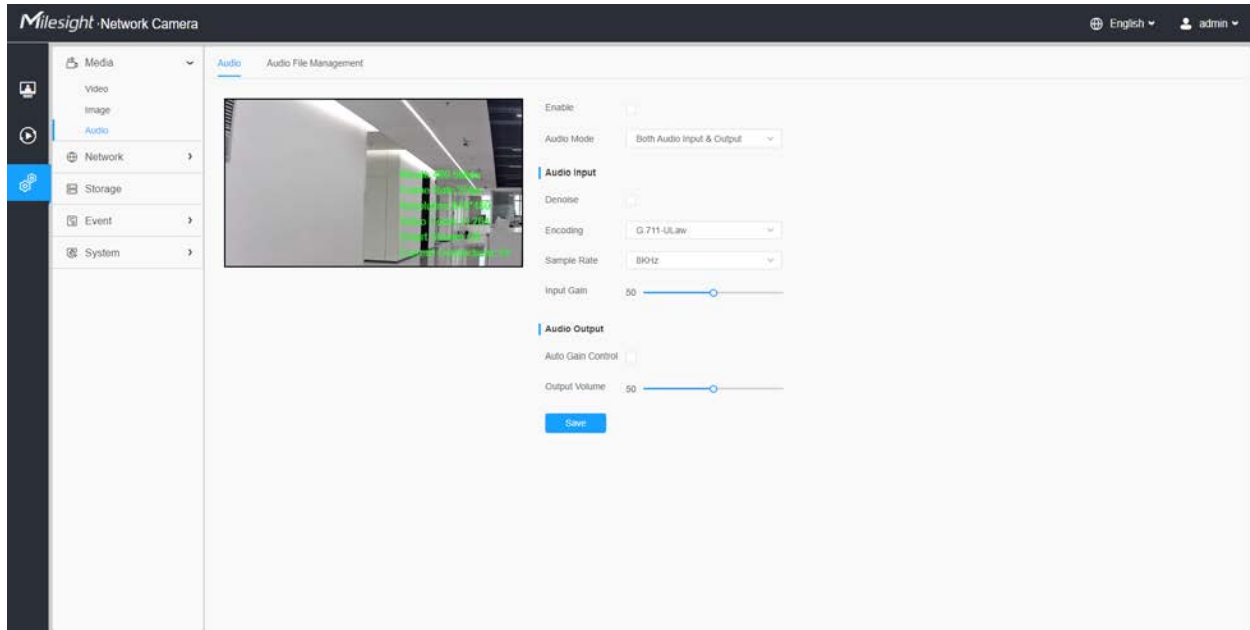
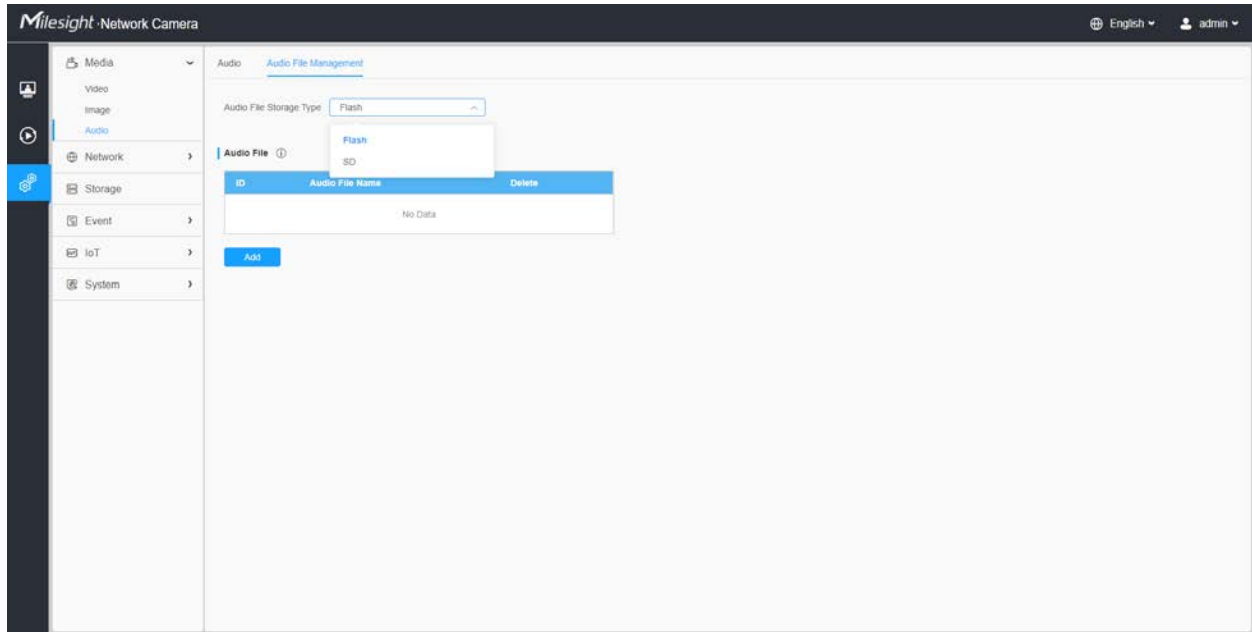

Table 92. Description of the buttons

Parameters	Function Introduction
Enable	Check on the checkbox to enable audio feature.
Audio Mode	Audio Input/Audio Output/Both Audio Input & Output are optional.
Audio Input	<p>Denoise: Set it as On/Off. When you set the function on, the noise detected can be filtered.</p> <p>Encoding: G.711-ULaw, G.711-ALaw, AAC LC, G.722 and G.726 are available</p> <p>Audio Bit Rate: The function is available only for AAC LC, and supports up to 48kbps.</p> <p>Sample Rate: 8KHz, 16KHz, 32KHz, 44.1KHz, and 48KHz are available.</p> <p>Input Gain: Input audio gain level, 0-100.</p> <p>Alarm Level: Alarm will be triggered if voice alarm is enabled and input gained volume is higher than the alarm level, 1-100.</p>
Audio Output	<p>Auto Gain Control: This function is only for H.265 series, improve the quality of audio</p> <p>Output Volume: Adjust volume of output</p>

Auto File Management

You can upload up to 5 audio files manually to Flash or SD Card on the Audio web page and you can also edit the audio file's name when upload.



Note:

- The Audio mode and Audio Output are only for certain modules.
- Only support '.wav' audio files with codec type PCM/PCMU/PCMA, 64kbps or 128 kbps and no more than 500k.

3.7.2 Network

3.7.2.1 Basic

TCP/IP

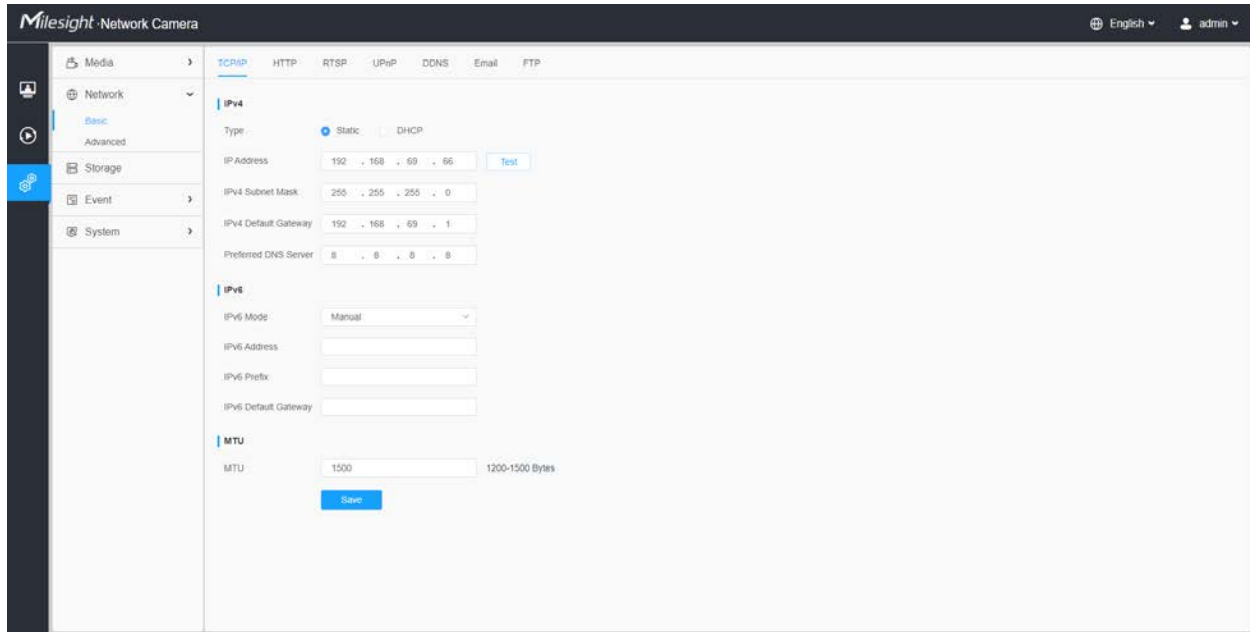



Table 93. Description of the buttons

Parameters	Function Introduction
IPv4	<p>Type: Static Type and DHCP Type are optional for user to get IPv4 address automatically or use fixed IP address.</p> <p>IPv4 Address: An address that used to identify a network camera on the network.</p> <p> Note: The Test button is used to test if the IP is conflicting.</p> <p>IPv4 Subnet Mask: It is used to identify the subnet where the network camera is located.</p> <p>IPv4 Default Gateway: The default router address.</p> <p>Preferred DNS Server: The DNS Server translates the domain name to IP address.</p>
IPv6	<p>IPv6 Mode: Choose different modes for IPv6: Manual/Route Advertisement/DHCPv6</p> <p>IPv6 Address: IPv6 Address used to identify a network camera on the network</p> <p>IPv6 Prefix: Define the prefix length of IPv6 address</p> <p>IPv6 Default Gateway: The default router IPv6 address</p>
MTU	<p>Maximum Transmission Unit. The default value is 1500. You can customize the value from 1200 to 1500 as needed.</p>
<div style="background-color: #007bff; color: white; padding: 5px; display: inline-block;">Save</div>	<p>Save the configuration.</p>

HTTP

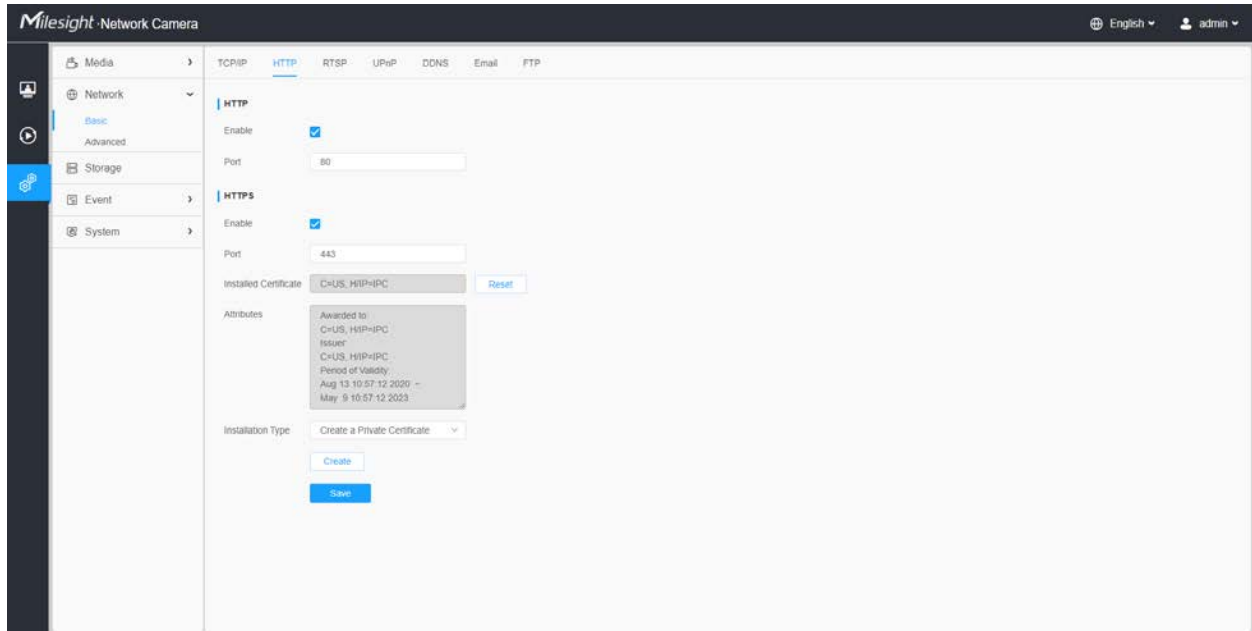

Table 94. Description of the buttons

Parameters	Function Introduction
HTTP	<p>Enable: Start or stop using HTTP.</p> <p>Port: Web GUI login port, the default is 80, the same with ONVIF port.</p>
HTTPS	<p>Enable: Start or stop using HTTPSs.</p> <p>Port: Web GUI login port via HTTPS, the default is 443.</p> <p>Note: For more details about how to use enable HTTPS access, please refer to https://milesight.freshdesk.com/a/solutions/articles/69000797384.</p>
Installed Certificate	Upload and set the SSL certificate.
Attributes	
Installation Type	
Save	Save the configuration.

Table 95. HTTP URL are as below:

Stream	URL
Main Stream	http://username:password@IP:port/ipcam/mjpeg.cgi
Secondary Stream	http://username:password@IP:port/ipcam/mjpegcif.cgi
Tertiary Stream	http://username:password@IP:port/ipcam/mjpegthird.cgi

RTSP

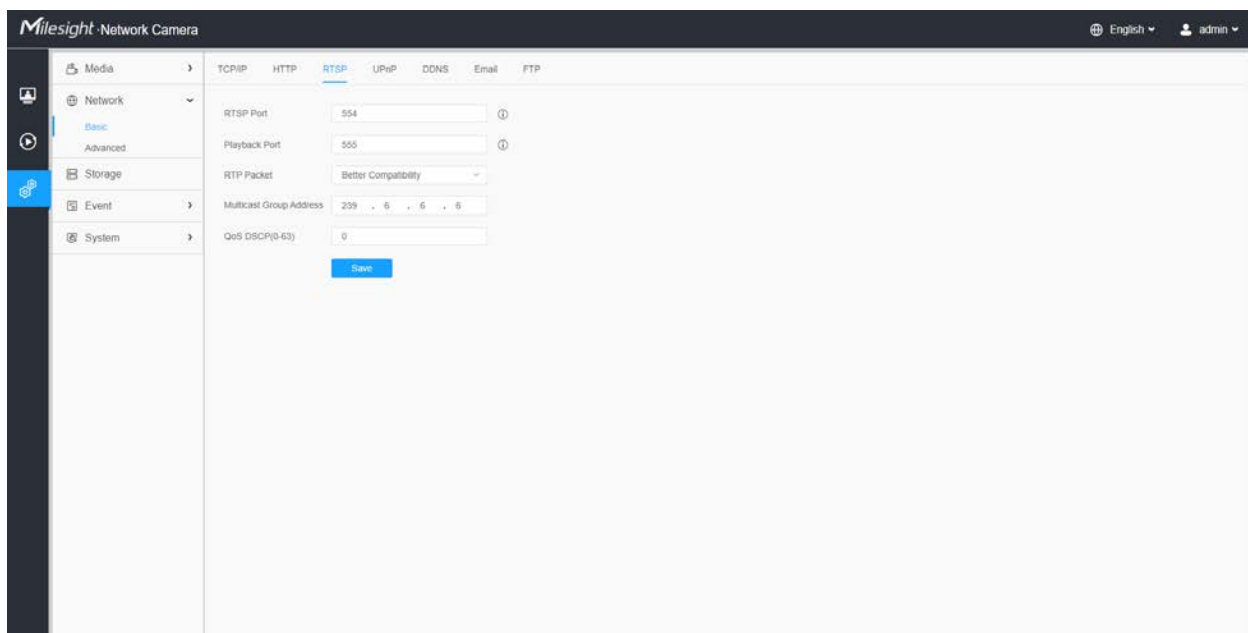



Table 96. Description of the buttons

Parameters	Function Introduction
RTSP Port	The port of RTSP, the default is 554.
Playback Port	Playback Port The port of playback, the default is 555.  Note: Port 0 means closing playback function.
RTP Packet	There are Better Compatibility and Better Performance two options, if your camera's image mess up, please switch this option.
Multicast Group Address	Support multicast function.

Parameters	Function Introduction
QoS DSCP	The valid value range of the DSCP is 0-63.
	Save the configuration.

Table 97. RTSP URL are as below:

Stream	URL
Primary Stream	rtsp://IP:RTSP Port/main
Secondary Stream	rtsp://IP:RTSP Port/sub
Tertiary Stream	rtsp://IP:RTSP Port/third

Note:

- DSCP refers to the Differentiated Service Code Point; and the DSCP value is used in the IP header to indicate the priority of the data.
- A reboot is required for the settings to take effect.

UPnP

Universal Plug and Play (UPnP) is a networking architecture that provides compatibility among networking equipment, software and other hardware devices. The UPnP protocol allows devices to connect seamlessly and to simplify the implementation of networks in the home and corporate environments. With the function enabled, you don't need to configure the port mapping for each port, and the camera is connected to the Wide Area Network via the router.

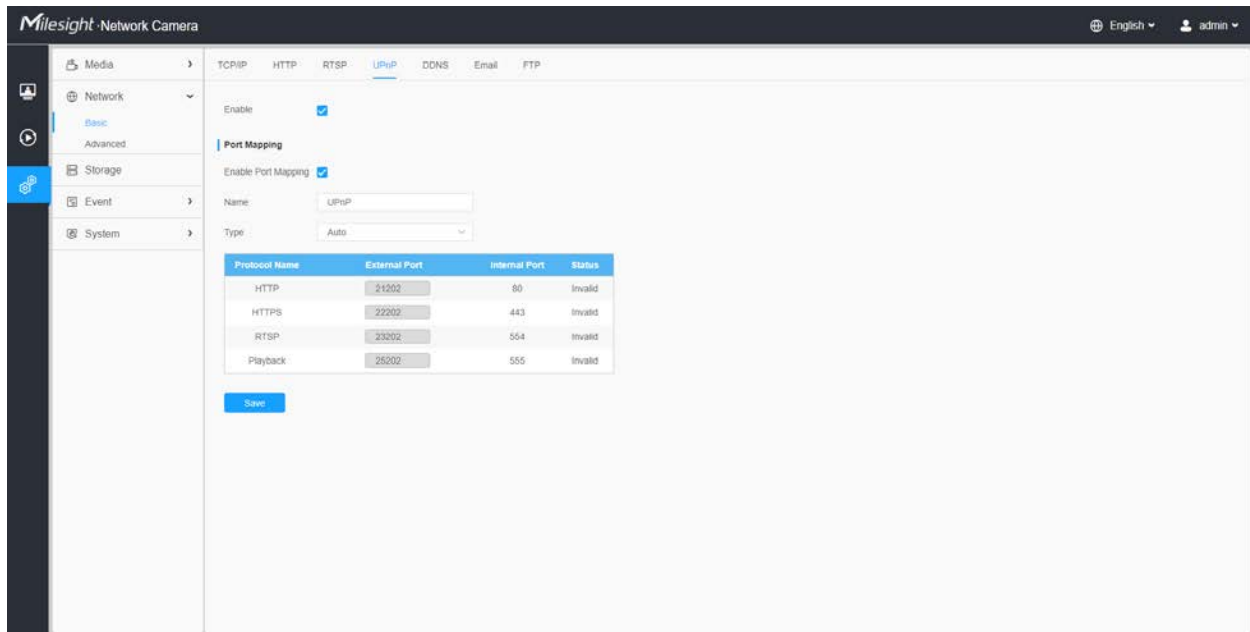

Table 98. Description of the buttons

Parameters	Function Introduction
Enable	Check the checkbox to enable the UPnP function.
Enable Port Mapping	Check the checkbox to enable the Port Mapping
Name	The name of the device detected online can be edited
Type	<p>Auto: Automatically obtain the corresponding HTTP and RTSP port, without any settings</p> <p>Manual: Need to manually set the appropriate HTTP port and RTSP Port. When choose Manual, you can customize the value of the port number by yourself</p>
Save	Save the configuration.

DDNS

DDNS allows you to access the camera via domain names instead of IP address. It manages to change IP address and update your domain information dynamically. You need to register an account from a provider.

Note: For more details about how to set DDNS, please refer to <https://milesight.freshdesk.com/a/solutions/articles/69000643406>.

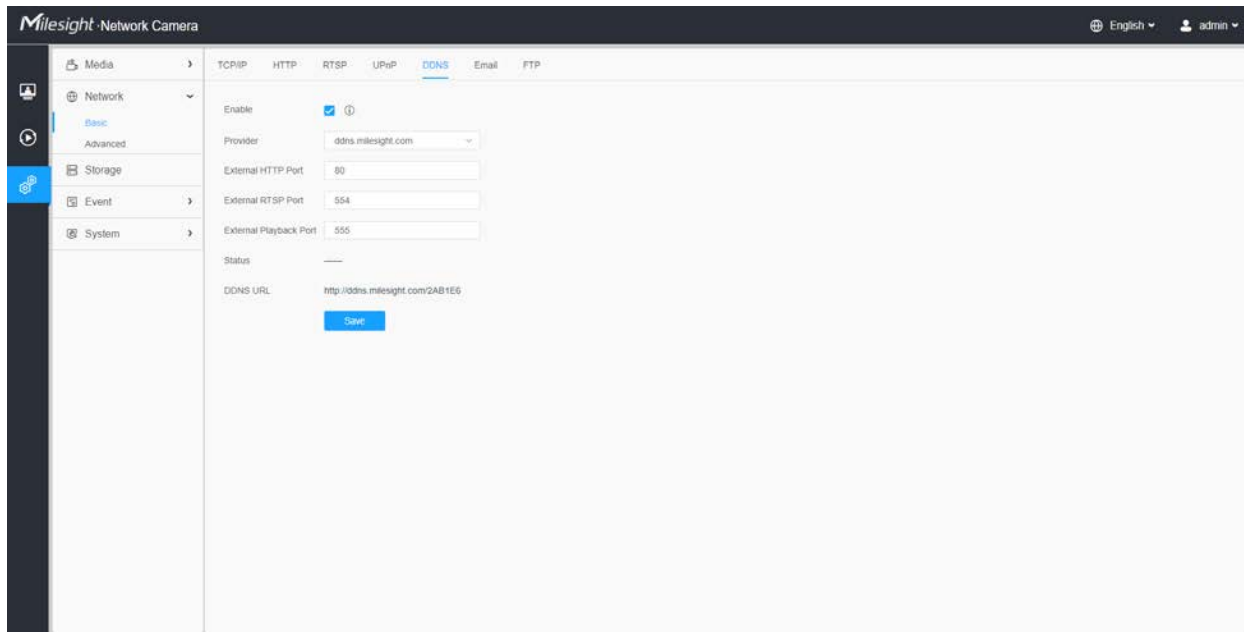

You can choose “ddns.milesight.com” as provider for DDNS. After enabling it, you can access the device via the URL “http://ddns.milesight.com/MAC address”.

Table 99. Description of the buttons

Parameters	Function Introduction
Enable DDNS	Check the checkbox to enable DDNS service.  Note: Recommend to enable and configure UPnP ports which can be used directly in DDNS.
Provider	Get support from DDNS provider: ddns.milesight.com, freedns.afraid.org, dyndns.org, www.no-ip.com, www.zoneedit.com. You can also customize the provider for DDNS.
Hash	A string used for verifying, only for "freedns.afraid.org".
User name	Account name from the DDNS provider, unavailable for "freedns.afraid.org".
Password	Account password, unavailable for "freedns.afraid.org".
Host name	DDNS name enabled in the account.
Status	Display DDNS running status.

Parameters	Function Introduction
<div style="text-align: center;"> Save </div>	Save the configuration.

 **Note:**

- Please do the Port Forwarding of HTTP Port and RTSP Port before you use Milesight DDNS.
- Make sure that the internal and the external port number of RTSP are the same.

Email

Alarm video files can be sent to specific mail account through SMTP server. You must configure the email settings correctly before using it.

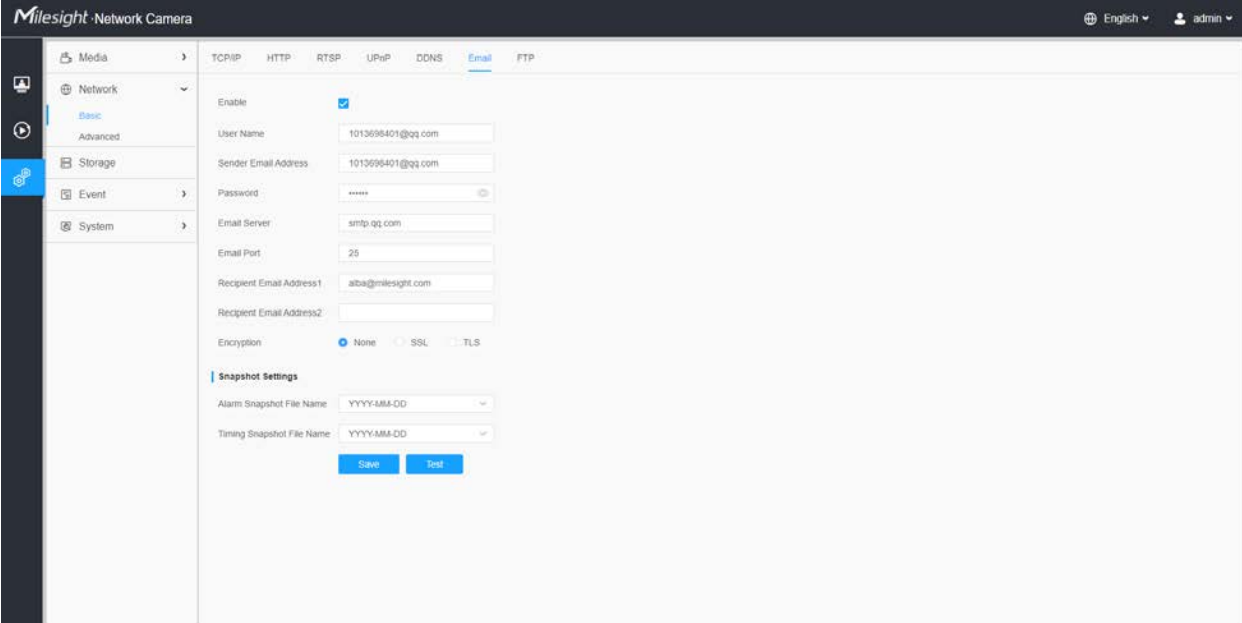





Table 100. Description of the buttons

Parameters	Function Introduction
<p style="text-align: center;">Enable</p>	Check the checkbox to enable Email function.
<p style="text-align: center;">User Name</p>	The sender's name. It is usually the same as the account name.
<p style="text-align: center;">Sender Email Address</p>	Email address to send video files attached emails.

Parameters	Function Introduction
Password	The password of the sender.
Email Server	The email server IP address or host name(e.g. smtp.gmail.com).
Email Port	The default TCP/IP port for SMTP is 25(not secured). For SSL/TLS port, it depends on the mail you use.
Recipient Email Address1	Email address to receive video files.
Recipient Email Address2	Email address to receive video files.
Encryption	Check the checkbox to enable SSL or TLS if it is required by the SMTP server.
Snapshot Settings	<p>Alarm Snapshot File Name: Default(YYYY-MM-DD) /MM-DD-YYYY/ DD-MM-YYYY/ Add prefix/ Overwrite with the base file name/ Customize are available.</p> <p>Timing Snapshot File Name: Default(YYYY-MM-DD) /MM-DD-YYYY/ DD-MM-YYYY/ Add prefix/ Overwrite with the base file name/ Customize are available.</p>
	Save the configuration.
	Test whether the configuration is successful.

 **Note:** You can refer to the following file name tip to customize the file name.

File Name Tip
 &Device - Device Name
 &Y - Year
 &M - Month
 &D - Day
 &h - hour
 &m - minute
 &s - second
 &ms - millisecond
 && - &

FTP

Alarm video files can be sent to specific FTP server. You must configure the FTP settings correctly before using it.

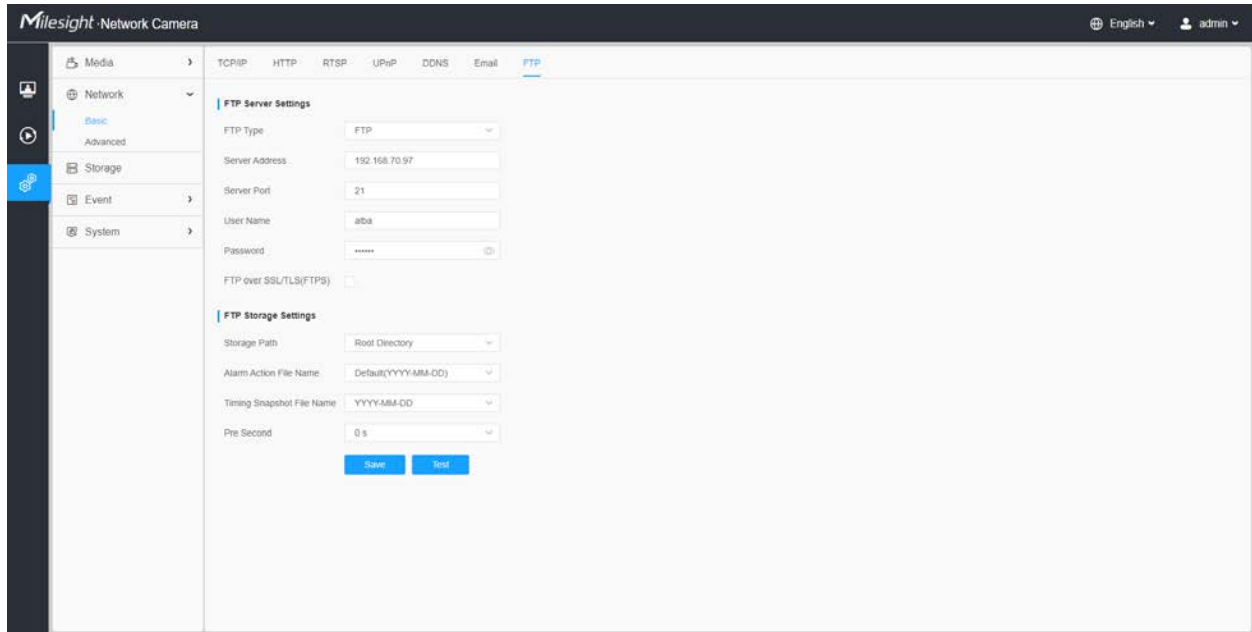

Table 101. Description of the buttons

Parameters		Function Introduction
FTP Server Settings	FTP Type	FTP and SFTP are optional.
	Server Address	FTP/SFTP server address.
	Server Port	The port of the FTP server. Generally it is 21. The port of the SFTP server. Generally it is 22.
	User Name	User name used to log in to the FTP/SFTP sever.
	Password	User password.
FTP Storage Settings	Storage Path	Storage Path where video and image will be uploaded to the FTP server. Four FTP storage path types are available, including Root Directory, Parent Directory, Child Directory and Customize.
	Parent Directory	Choose IP Address/ Device Name/ Date as the folder name of Parent Directory, or customize the folder name.
	Child Directory	Choose IP Address/ Device Name/ Date as the folder name of Child Directory, or customize the folder name.

Parameters		Function Introduction
FTP Storage Settings	Multilevel Folder Name	If the storage path is more than two levels, enter Multilevel FTP storage path here manually.
	Alarm Action File Name	Choose the default(YYYY-MM-DD) or customize the alarm action file name.
	Video File Name	If you choose to customize the alarm action file name, YYYY-MM-DD/ MM-DD-YYYY/ DD-MM-YYYY/ Add prefix are available.
	Image File Name	If you choose to customize the alarm action file name, YYYY-MM-DD/ MM-DD-YYYY/ DD-MM-YYYY/ Add prefix are available.
	Timing Snapshot File Name	Default(YYYY-MM-DD) /MM-DD-YYYY/ DD-MM-YYYY/ Add prefix/ Overwrite with the base file name are available.
	Pre Second	Reserve the record time before alarm, 0~10 sec.
Save		Save the configuration, 0s ~ 10s are optional.
Test		Test whether the configuration is successful.

 **Note:**

- Parent Directory will be under Root Directory, and Child Directory will be under Parent Directory.
- You can refer to the following file name tip to customize the file name.

3.7.2.2 Advanced

VLAN

A virtual LAN (VLAN) is any broadcast domain that is partitioned and isolated in a computer network at the data link layer (OSI layer 2). LAN is an abbreviation of local area network. VLANs allow network administrators to group hosts together even if the hosts are not on the same network switch. This can greatly simplify network design and deployment, because VLAN membership can be configured through software. Without VLANs, grouping hosts according to their resource needs necessitates the labour of relocating nodes or rewiring data links.

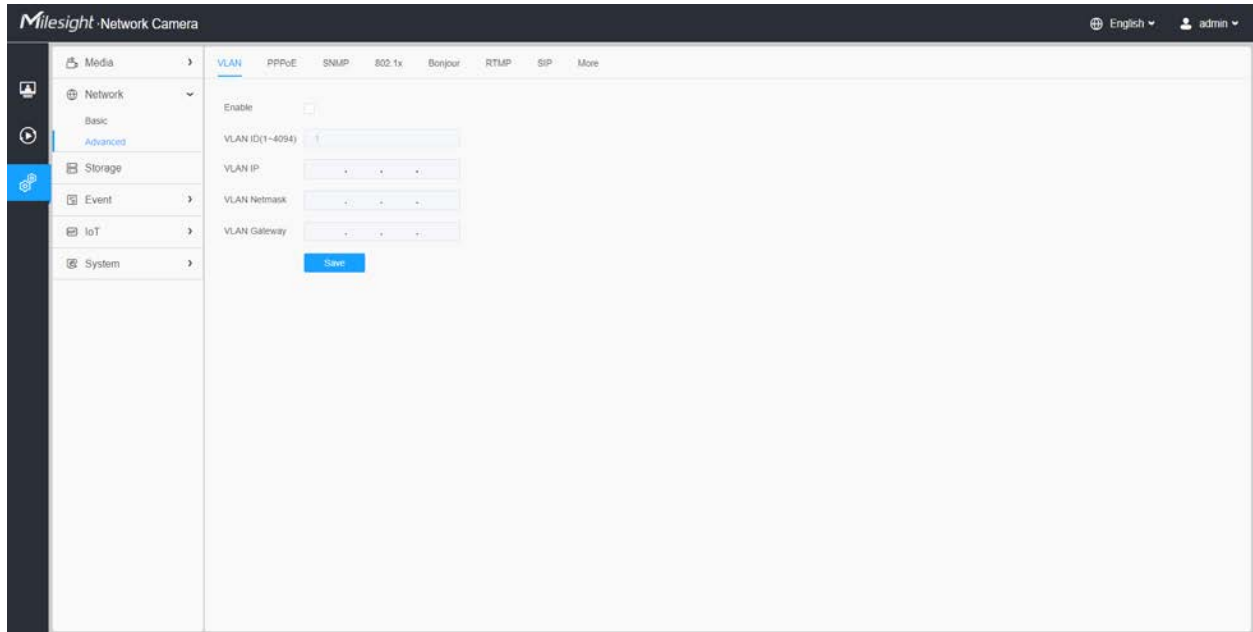

Note: About how to set up VLAN in switches, please refer to your switches user manual.

PPPoE

This camera supports the PPPoE auto dial-up function. The camera gets a public IP address by ADSL dial-up after the camera is connected to a modem. You need to configure the PPPoE parameters of the network camera.

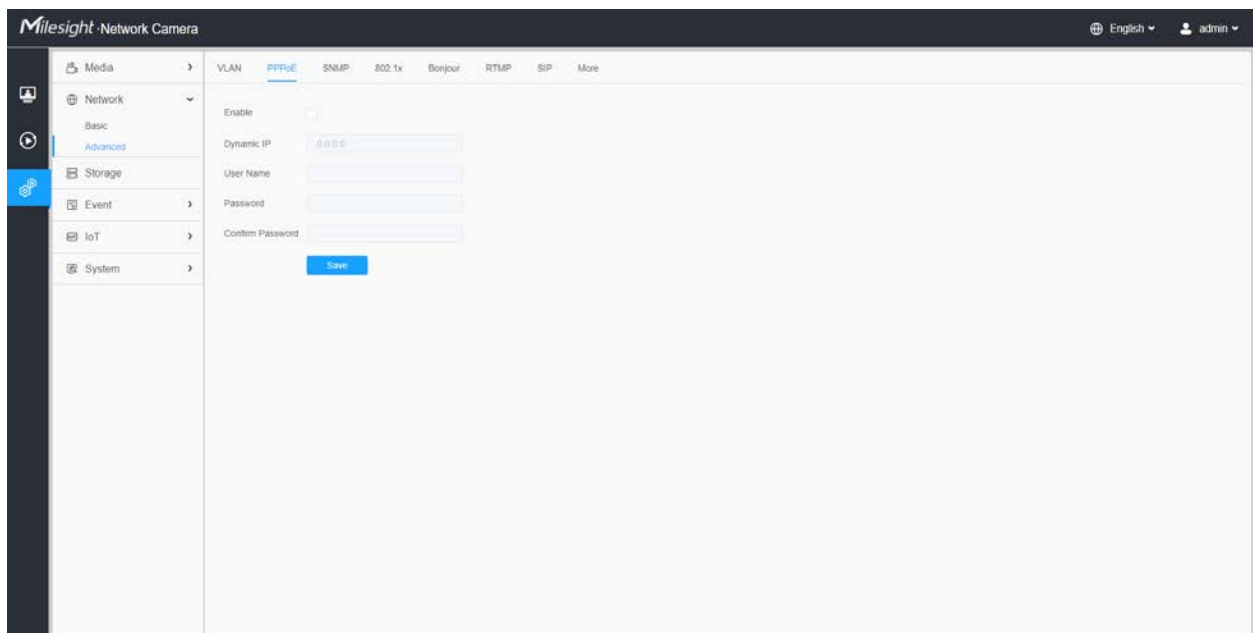

Note:

- The obtained IP address is dynamically assigned via PPPoE, so the IP address always changes after rebooting the camera. To solve the inconvenience of the dynamic IP, you need to get a domain name from the DDNS provider (e.g. DynDns.com).
- The user name and password should be assigned by your ISP.

SNMP

You can set the SNMP function to get camera status, parameters and alarm related information and manage the camera remotely when it is connected to the network.

Before setting the SNMP, please download the SNMP software and manage to receive the camera information via SNMP port. By setting the Trap Address, the camera can send the alarm event and exception messages to the surveillance center.

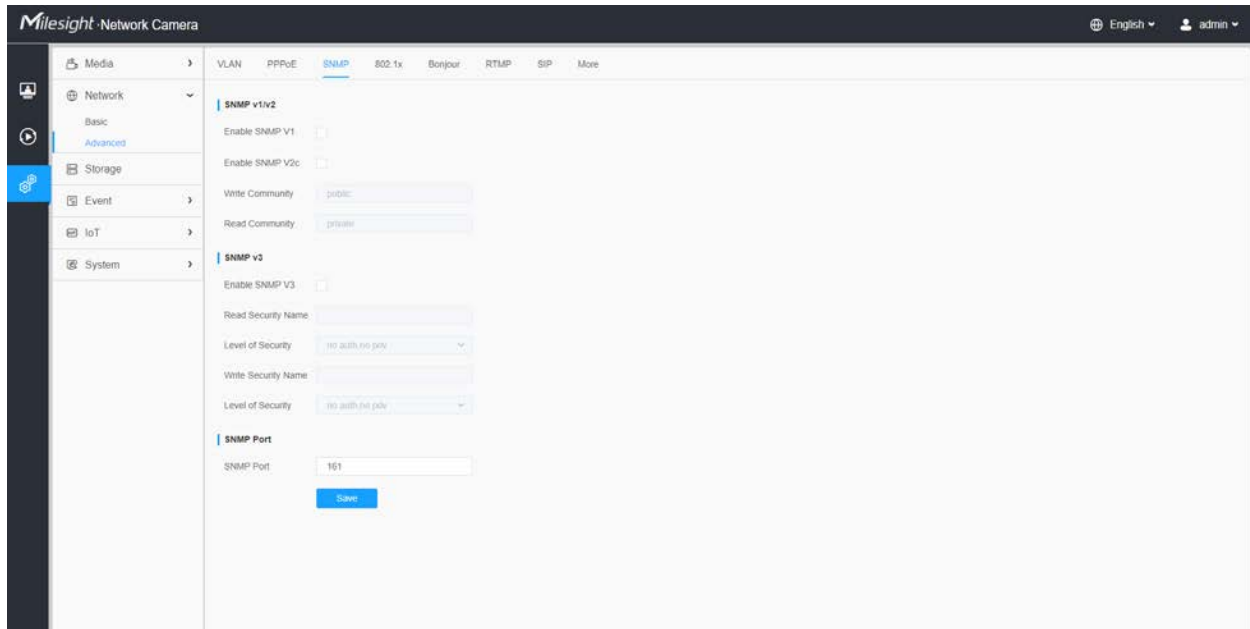

Table 102. Description of the buttons

Parameters	Function Introduction
SNMP v1/v2	<p>The version of SNMP, please select the version of your SNMP software.</p> <p>Enable SNMP v1: Provide no security.</p> <p>Enable SNMP v2: Require password for access.</p> <p>Write Community: Input the name of Write Community.</p> <p>Read Community: Input the name of Read Community</p>

Parameters	Function Introduction
SNMP v3	<p>Enable SNMP v3: Provide encryption and the HTTPS protocol must be enabled.</p> <p>Read Security Name: Input the name of Read Security Community.</p> <p>Level of Security: There are three levels available: (auth, priv), (auth, no priv) and (no auth, no priv).</p> <p>Write Security Name: Input the name of Write Security Community.</p> <p>Level of Security: There are three levels available: (auth, priv), (auth, no priv) and (no auth, no priv).</p>
SNMP Port	The port of SNMP, the default is 161.
Save	Save the configuration.

Note:

- The settings of SNMP software should be the same as the settings you configure here;
- A reboot is required for the settings to take effect.

802.1x

The IEEE 802.1X standard is supported by the network cameras, and when the feature is enabled, the camera data is secured and user authentication is needed when connecting the camera to the network protected by the IEEE 802.1X.

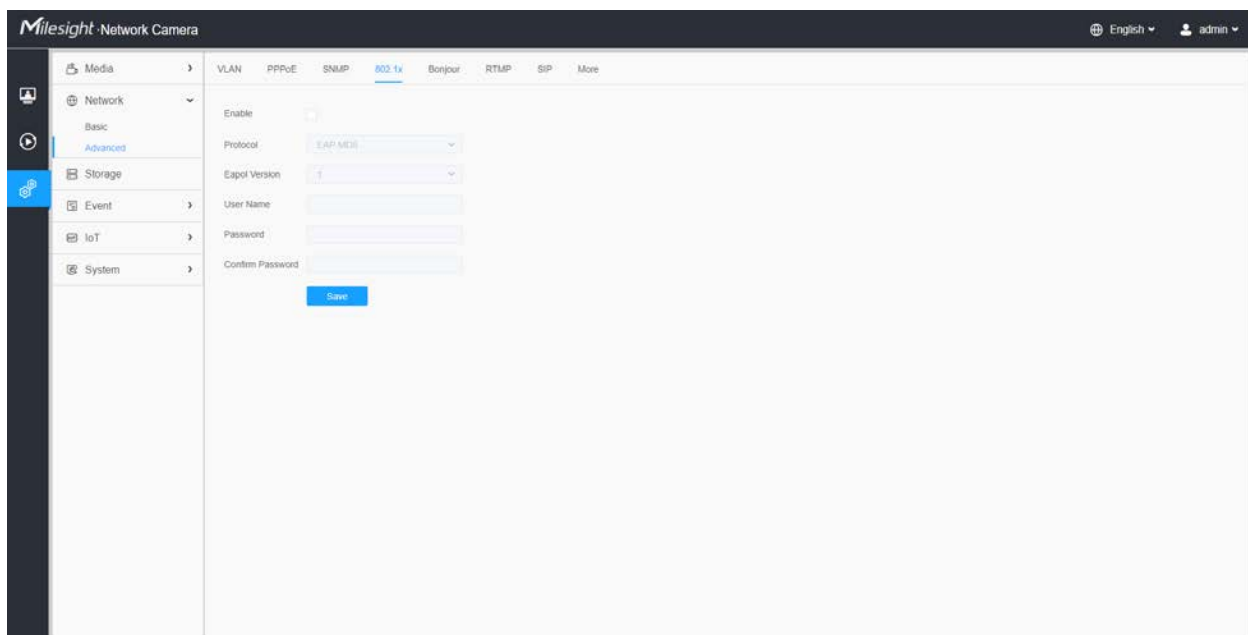

Bonjour

Bonjour is based on Apple's multicast DNS service. Bonjour devices can automatically broadcast their service information and listen to the service information of other devices.

If you don't know the camera information, you can use the Bonjour service on the same LAN to search for network camera devices and then to access the devices.

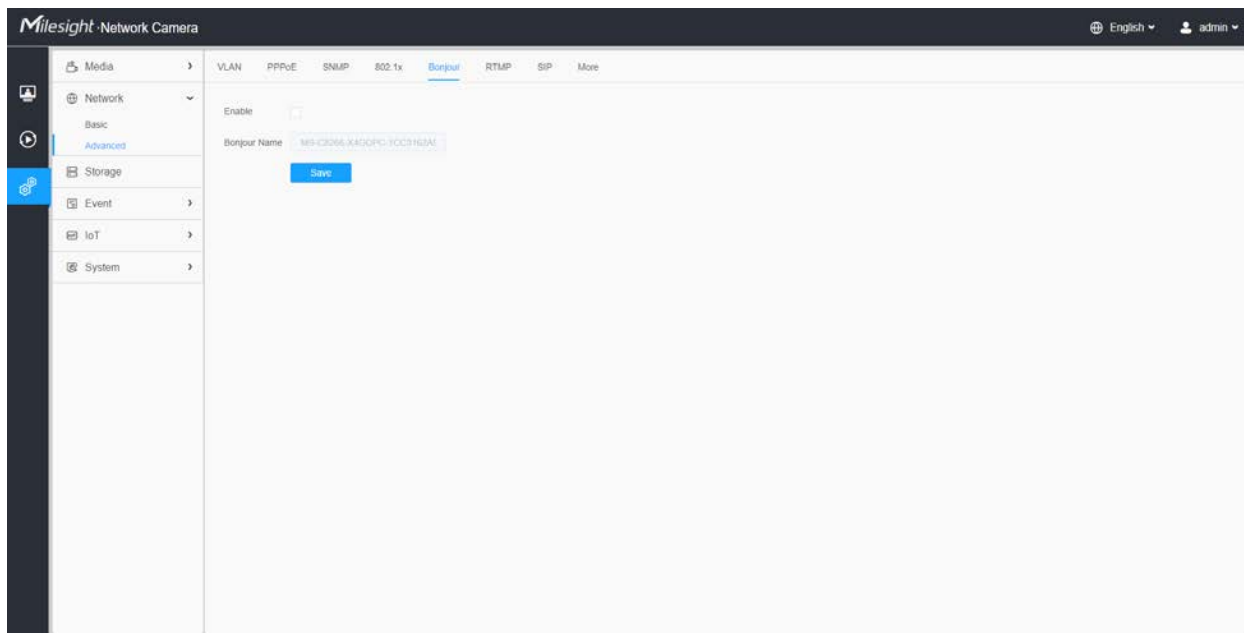

RTMP

Real-Time Messaging Protocol (RTMP) was initially a proprietary protocol for streaming audio, video and data over the Internet, between a Flash player and a server. RTMP is a TCP-based protocol which maintains persistent connections and allows low-latency communication. It can realize the function of live broadcast so that customers can log in to the camera wherever there is a network.

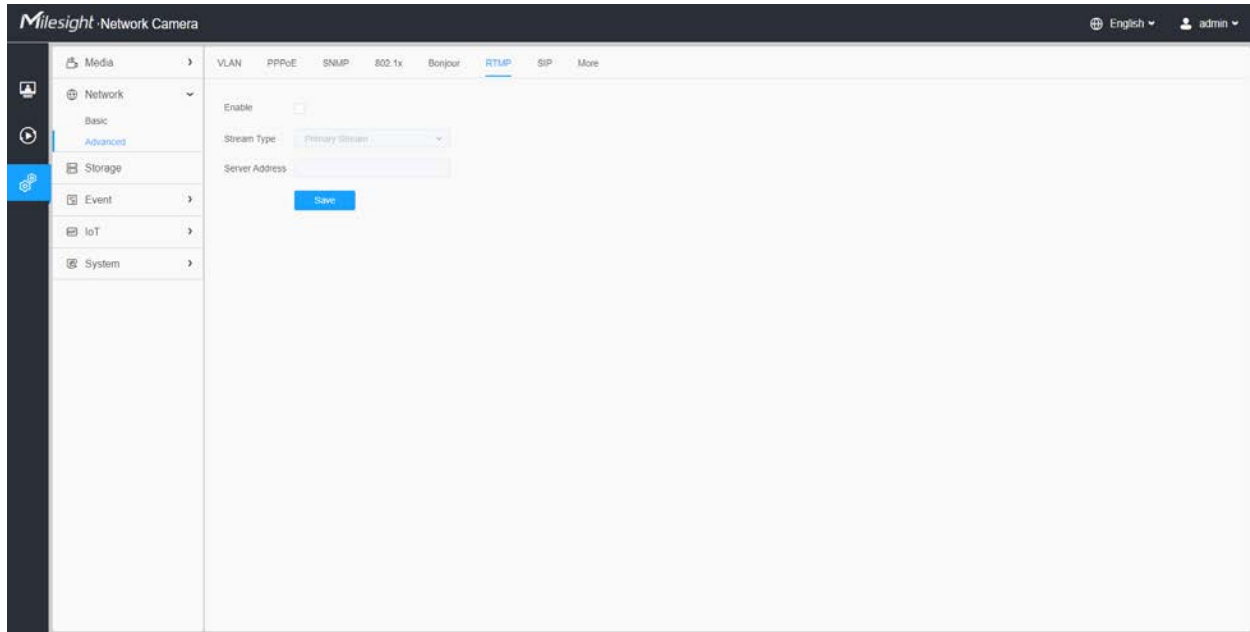

Note:

- For YouTube live broadcast, if you use a newly created account to live broadcast, you need to wait for 24hrs to activate the account for using live function.
- For RTMP, since G.711 is not available for YouTube, so you can only play video from MileSight Network Camera with H.264 video coding and AAC audio coding on YouTube.
- Server Address in Network Camera RTMP interface needs to be filled with the format: `rtmp://< Server URL >/< Stream key >`, remember it needs '/' to connect between < Server URL > and < Stream key >.
- For more details about how to use RTMP for live broadcast, please refer to <https://milesight.freshdesk.com/a/solutions/articles/69000643313>.

SIP

The Session Initiation Protocol(SIP) is a signaling communications protocol, widely used for controlling multimedia communication sessions such as voice and video calls over Internet Protocol (IP) networks. This page allows user to configure SIP related parameters. MileSight Network cameras can be configured as SIP endpoint to call out when alarm triggered; or allow permitted number to call in to check the video if the video IP phone is used.

 **Note:** For more details about how to use SIP, please refer to <https://milesight.freshdesk.com/a/solutions/articles/69000643391>.

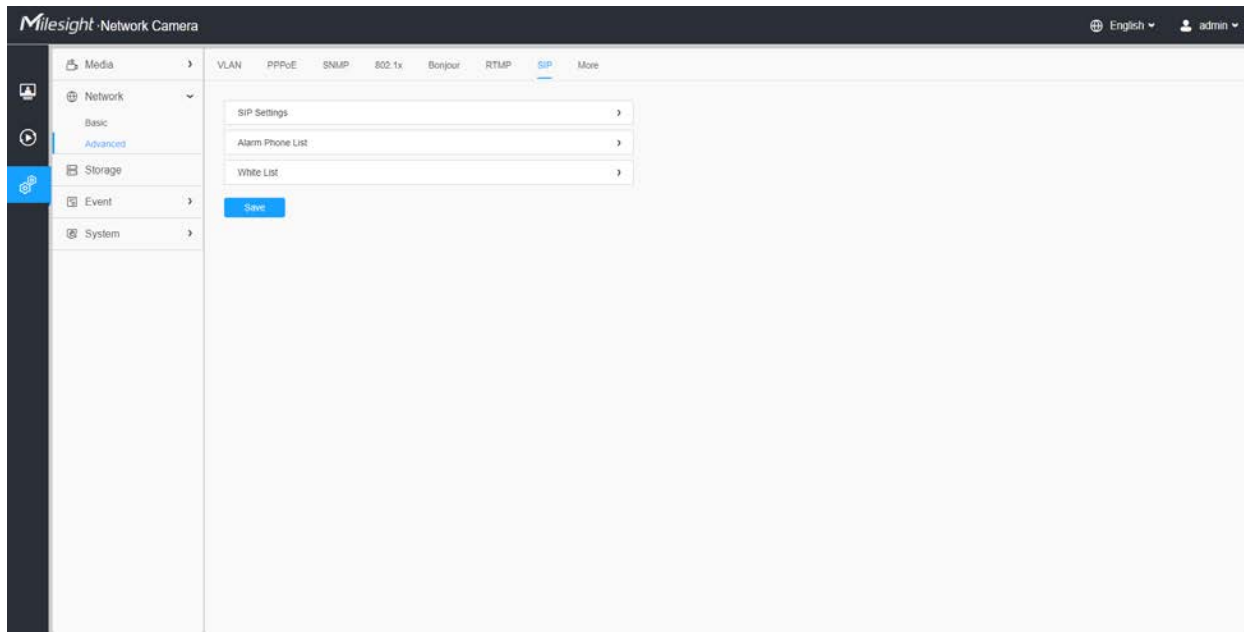

To use this function, the settings in SIP page must be configured properly. There are two ways to get video through SIP, one is to dial the IP address directly, the other is account registration mode. the details are as follows:

Method 1: IP Direct mode

Dial on the camera's IP address directly through SIP phone, so you can see the video.

 **Note:** SIP phone and the camera should in the same network segment.

Method2: Account registration mode

- Before using the SIP, you need to register an account for the camera from the SIP server;
- Register another user account for the SIP device from the same SIP server;
- Call the camera User ID from the SIP device, you will get the video on the SIP device.

[SIP Settings]

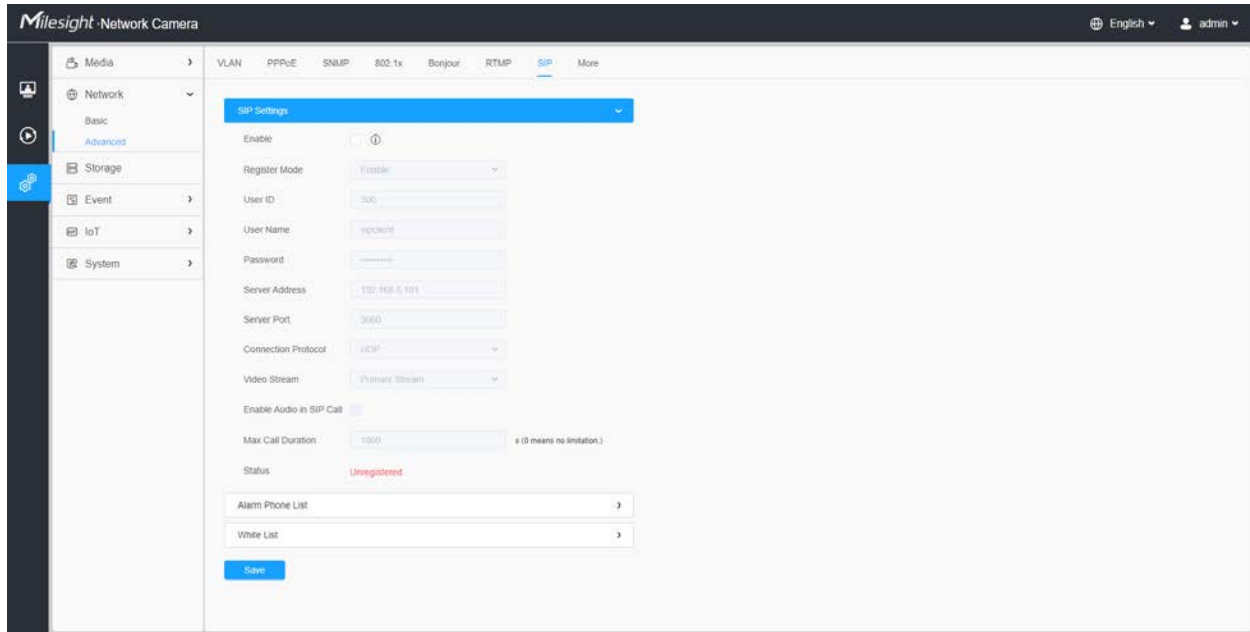



Table 103. Description of the buttons

Parameters	Function Introduction
Enable	Start or stop using SIP.  Note: SIP supports Direct IP call.
Register Mode	Choose to use Enable mode or Disable mode. Enable mode means to use SIP with register account. Disable mode refers to use SIP without register account, just use the IP address to call.
User ID	SIP ID.
User Name	SIP account name.
Password	SIP account password.
Server Address	Server IP address.
Server Port	Server port.
Connection Protocol	UDP/TCP.
Video Stream	Choose the video stream.

Parameters	Function Introduction
Enable Audio in SIP Call	Enable/disable audio in SIP call.
Max Call Duration	The max call duration when use SIP.
Status	SIP registration status. Display “Unregistered” or “Registered” .

[Alarm Phone List]

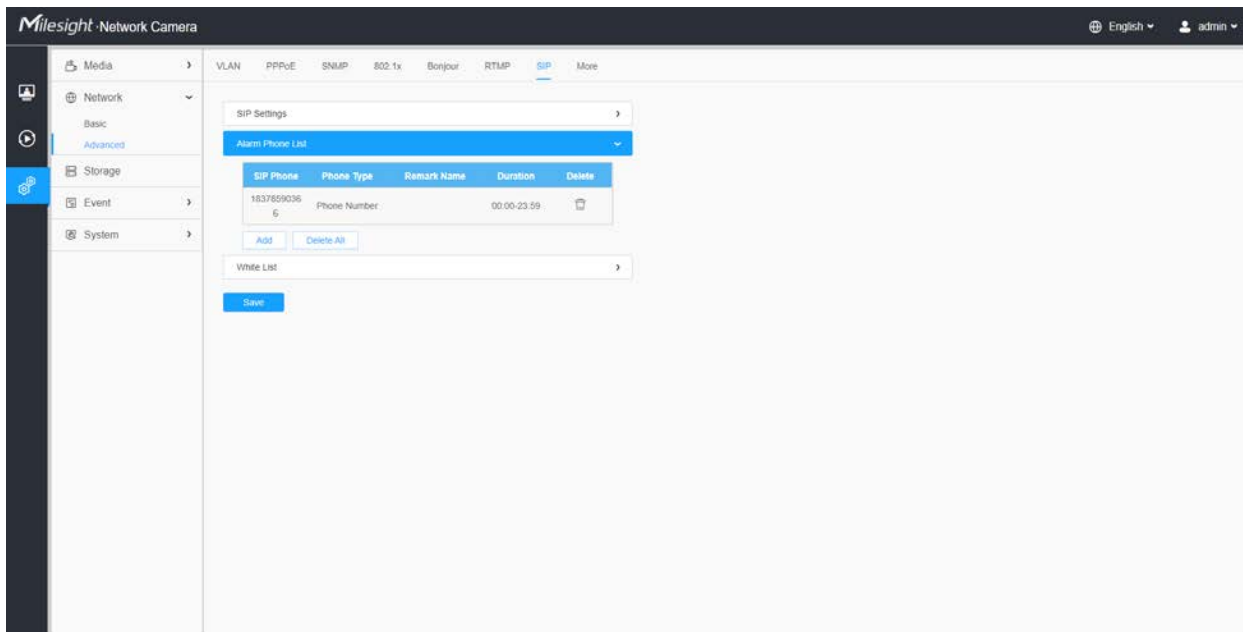
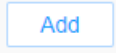



Table 104. Description of the buttons

Parameters	Function Introduction
	Add alarm phone to the camera. Phone Type: Phone Number(Call by phone number) & Direct IP Call(Check to accept peer to peer IP call). To Phone Number/IP Address: Call by phone number or IP address. Remark Name: Display name. Duration: The time schedule to use SIP.
	Delete the selected alarm phone.
	Delete all added alarm phone.

[White List]

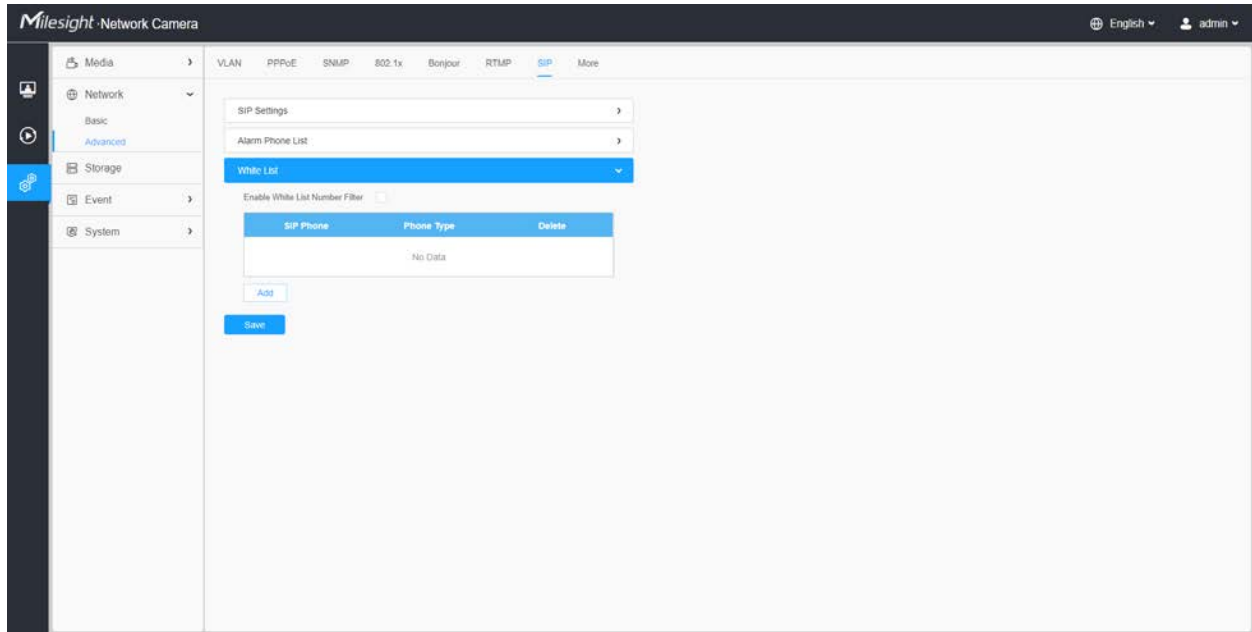
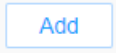

Table 105. Description of the buttons

Parameters	Function Introduction
<p>Enable White List Number Filter</p>	<p>When enabled, only the designated phone number or IP address can visit</p>
<p></p>	<p>Phone Type: Phone Number(Call by phone number) & Direct IP Call. Phone Number/IP Address: Including the phone number or IP address on the white list.</p>

More

Here you can set more functions, like Push Message Settings and ONVIF Settings.

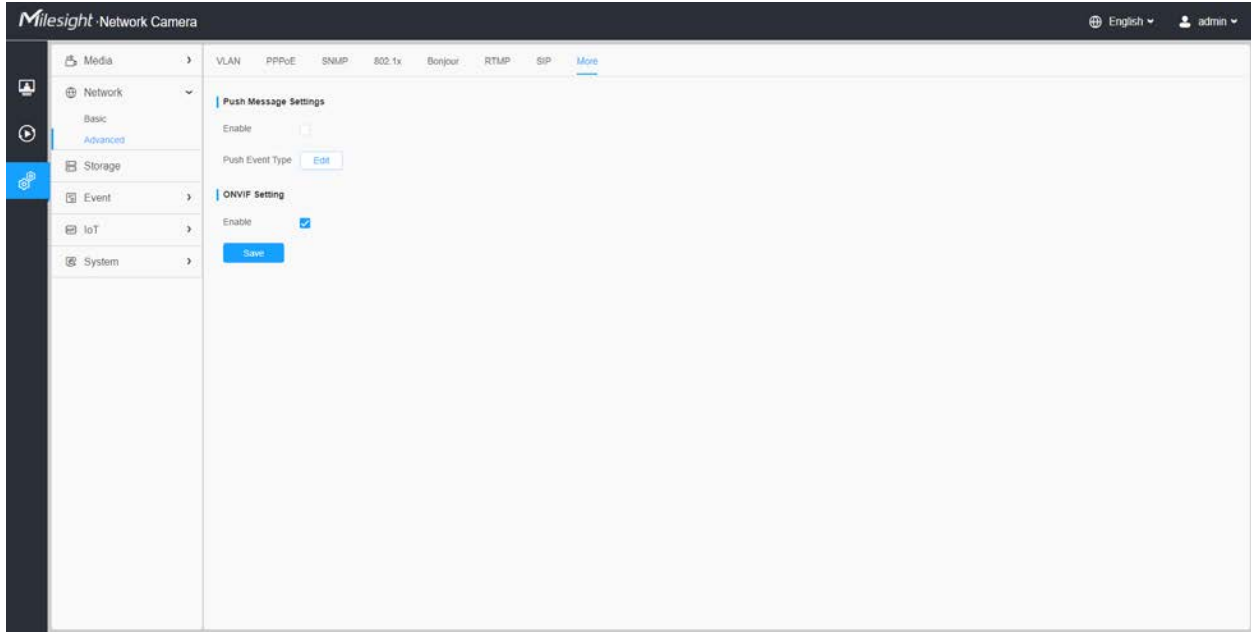

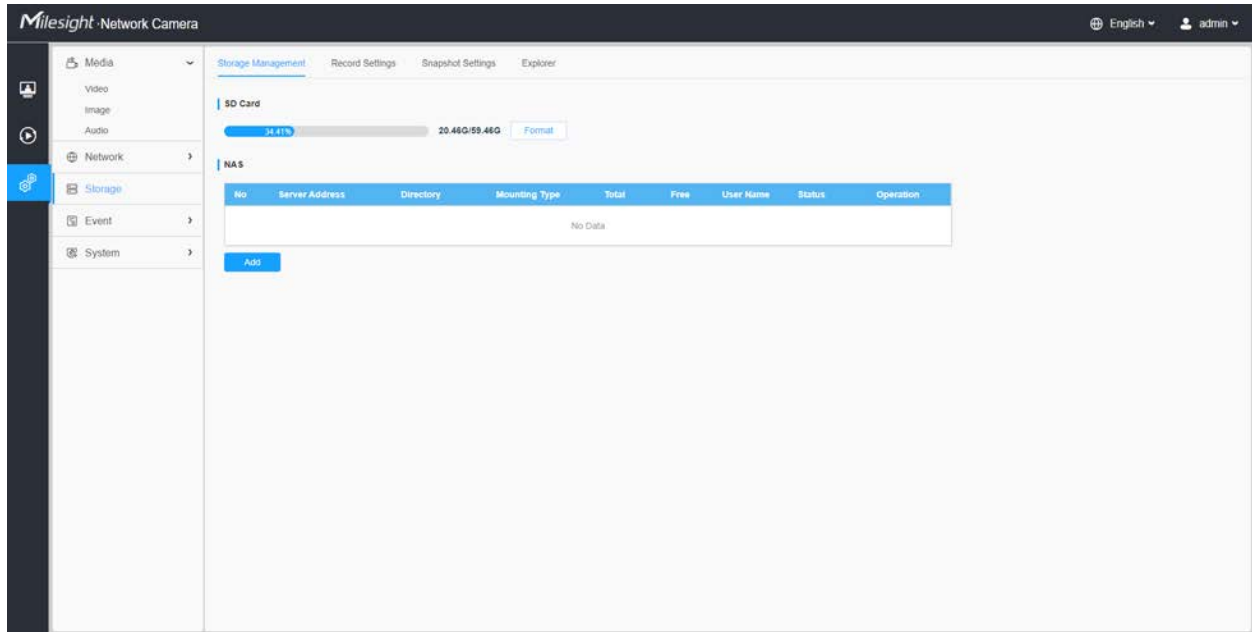

Table 106. Description of the buttons

Parameters	Function Introduction
<p>Push Message Settings</p>	<p>Enable: Enable/disable the Push Message function</p> <p>Push Event Type: You can click  to choose the types of Events' message which will be pushed to M-sight Pro App as shown below:</p> <div data-bbox="576 1144 1372 1501" style="border: 1px solid gray; padding: 5px;"> <p style="text-align: center; background-color: #007bff; color: white; margin: -1px -1px 1px -1px;">Edit ×</p> <p>Push Event Type</p> <p><input checked="" type="checkbox"/> All</p> <p><input checked="" type="checkbox"/> Motion Detection <input checked="" type="checkbox"/> Audio Alarm <input checked="" type="checkbox"/> External Input</p> <p><input checked="" type="checkbox"/> LPR Black <input checked="" type="checkbox"/> LPR White <input checked="" type="checkbox"/> LPR Visitor</p> <p style="text-align: center;"> <input type="button" value="Save"/> <input type="button" value="Cancel"/> </p> </div>
<p>ONVIF Setting</p>	<p>Here you can choose whether to enable or disable camera ONVIF function. If camera ONVIF function is enabled, it can be searched out, added and connected by third-party software through ONVIF protocols. Generally, the default status of ONVIF function is enabled.</p>

3.7.3 Storage

Storage Management



Note: Before you start:

- To configure record settings, please make sure that you have the network storage device within the network or the SD card inserted in your camera.
- Choose the storage mode according to your needs.

Table 107. Description of the buttons

Parameters	Function Introduction
SD Card	<p>Format: Format SD card, the files in SD card will be removed.</p> <p>Mount/UnMount: Mount/Dismount SD card.</p> <p>Delete: Enable cyclic storage, when the free disk space reach at a certain value, it will automatically delete the files at certain percentage according to your settings.</p>

Parameters	Function Introduction
<p style="text-align: center;">Nas</p>	<p>The network disk should be available within the network and properly configured to store the recorded files, etc.</p> <p>NAS (Network-Attached Storage), connecting the storage devices to the existing network, provides data and files services.</p> <div data-bbox="607 459 1403 852" style="border: 1px solid #ccc; padding: 10px; background-color: #f9f9f9;"> <div style="background-color: #00a0e3; color: white; padding: 5px; text-align: right; display: flex; justify-content: space-between;"> Add × </div> <div style="margin-top: 10px;"> <p>Server Address* <input style="width: 100%;" type="text"/></p> <p>Directory* <input style="width: 100%;" type="text"/></p> <p>Mounting Type NFS ▼</p> <div style="display: flex; justify-content: center; gap: 20px; margin-top: 10px;"> Save Cancel </div> </div> </div> <p>Server Address: IP address of NAS server.</p> <p>Directory: Input the NAS directory, e.g. “\path”.</p> <p>Mounting Type: NFS and SMB/CIFS are available. And you can set the user name and password to guarantee the security if SMB/CIFS is selected.</p> <p> Note:</p> <ul style="list-style-type: none"> Up to 5 NAS disks can be connected to the camera. For more details about how to use NAS on Milesight Network Camera, please refer to https://milesight.freshdesk.com/a/solutions/articles/69000797902.

Record Settings

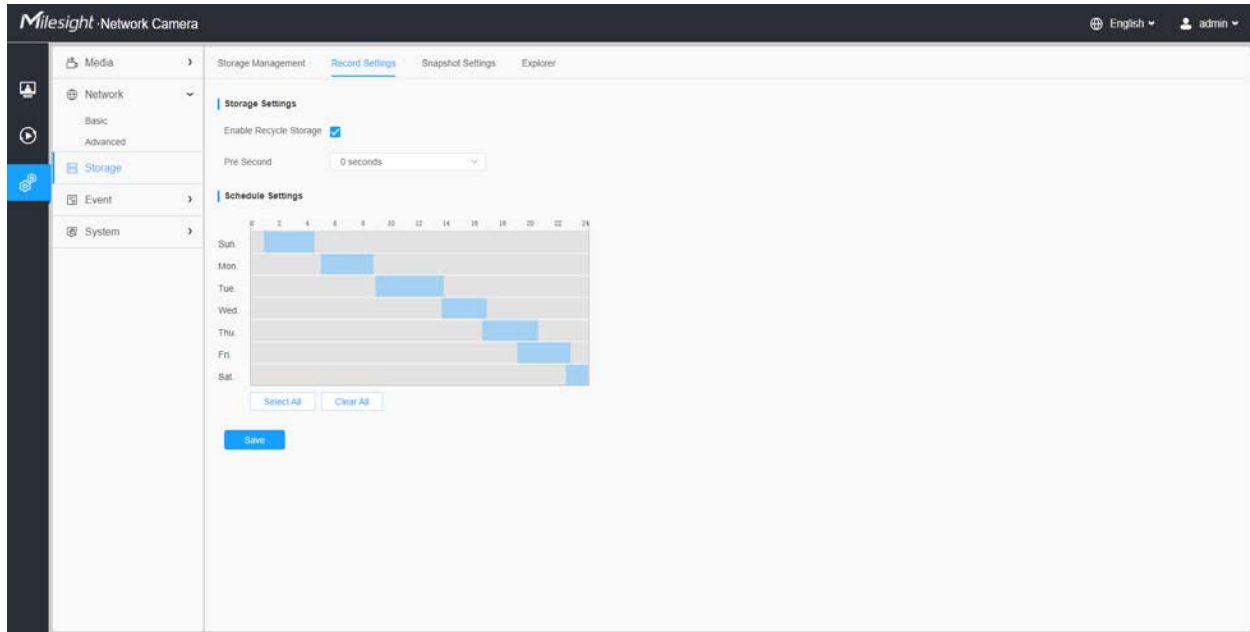
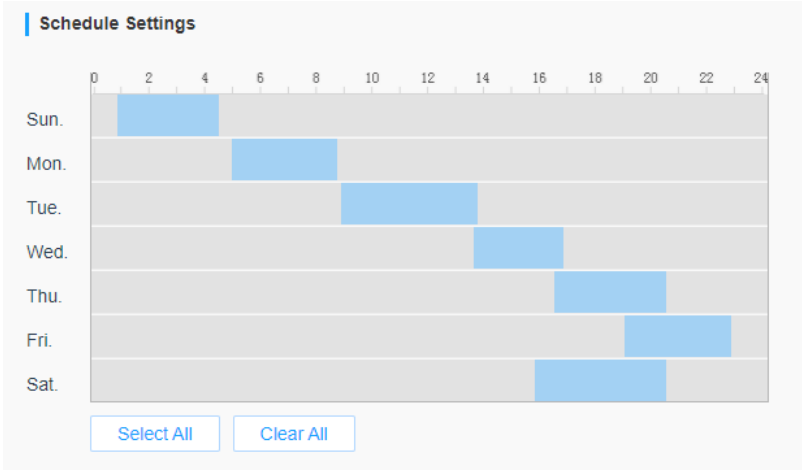
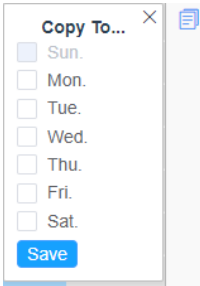
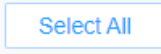

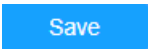



Table 108. Description of the buttons

Parameters	Function Introduction
Enable Recycle Storage	Enable/Disable Recycle Storage, if you enable this option, it will delete the files when the free disk space reaches a certain value.
Pre Second	Reserve the record time before alarm, 0~10 sec.
Schedule Settings	Edit record schedule as needed. Intuitive scheduling by drawing the time bar directly. 

Parameters	Function Introduction	
Schedule Settings		Copy the schedule area to another date.
		Select all schedule.
		Clear all schedule.
	Save the configuration.	

 **Note:** SD Card or NAS are available.

Snapshot Settings

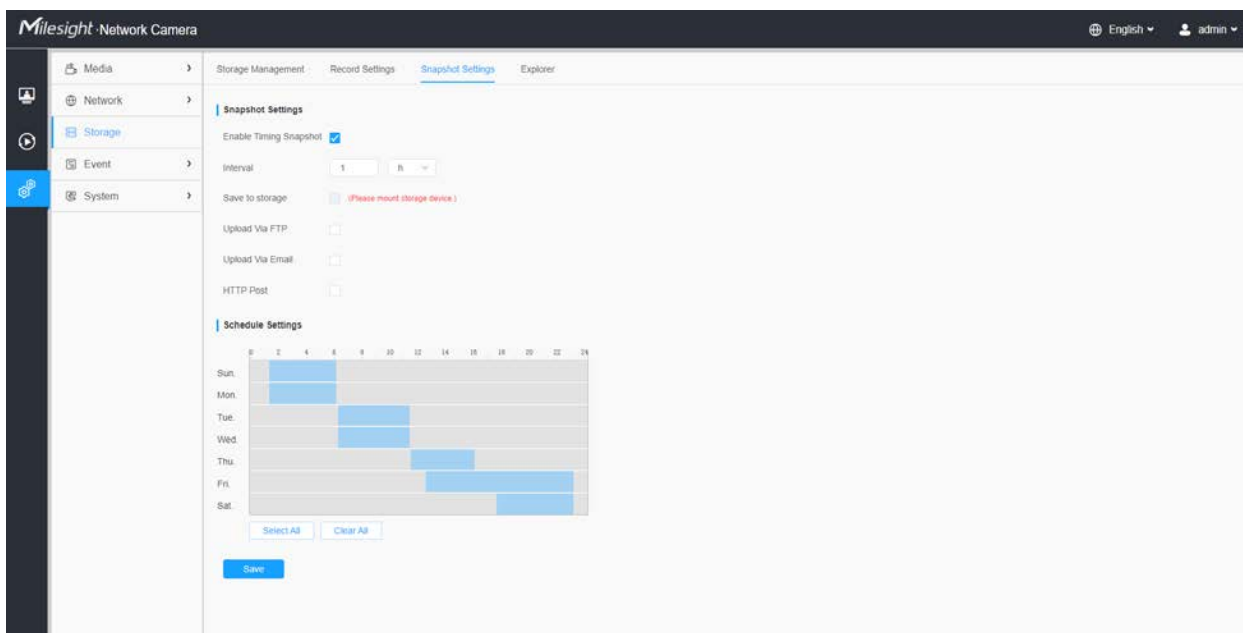

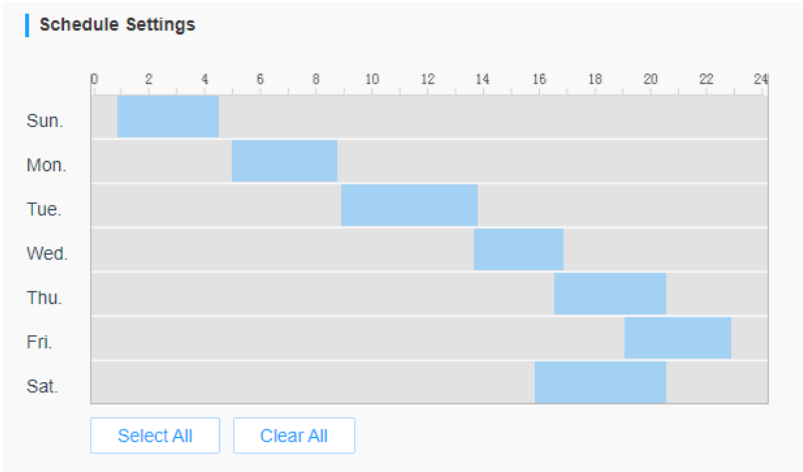
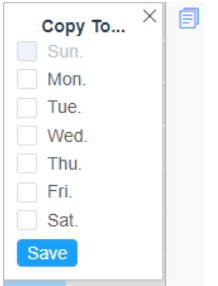
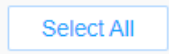



Table 109. Description of the buttons

Parameters	Function Introduction	
<p>Snapshot Settings</p>	<p>Enable Timing Snapshot: Check the checkbox to enable the Timing Snapshot function</p> <p>Interval: Set the snapshots interval, input the number and choose the unit(millisecond, second, minute, hour, day).</p> <p>Save Into Storage: Save the snapshots into SD card or NAS, and choose the file name to add time suffix or overwrite the base file name.</p> <p>Save Into NAS: Save the snapshots into NAS, and choose the file name to add time suffix or overwrite the base file name.</p> <p>Upload Via FTP: Upload the snapshots via FTP.</p> <p>Upload Via Email: Upload the snapshots via Email.</p> <p> Note: If you choose to add time suffix, every snapshot picture will be saved, but if you choose to overwrite the base file name, only one latest picture will be saved. When you choose add overwrite the base file name to SD Card or NAS, it will create a file named "Snapshot" to place the snapshot.</p> <p>HTTP Post: Upload the snapshots via HTTP Post. Support uploading the snapshots to specified HTTP URL.</p>	
<p>Schedule Settings</p>	<p>Edit record schedule as needed. Intuitive scheduling by drawing the time bar directly.</p> 	
<p>Schedule Settings</p>		<p>Copy the schedule area to another date.</p>
		<p>Select all schedule.</p>

Parameters	Function Introduction	
	<div style="border: 1px solid #ccc; padding: 2px; display: inline-block;">Clear All</div>	Clear all schedule.
<div style="background-color: #007bff; color: white; padding: 5px; display: inline-block;">Save</div>	Save the configuration.	

Explorer

Files will be seen on this page when they are configured to save into SD card or NAS. You can set time schedule every day for recording videos and save video files to your desired location.

 **Note:** Files are visible once SD card is inserted. Don't insert or pull out SD card when power on

Video files are arranged by date. Set file type and start/end time to search out files. Each day files will be displayed under the corresponding date, from here you can copy and delete files etc. You can visit the files in SD card by ftp, for example, ftp://username:password@192.168.5.190(user name and password are the same as the camera account and the IP followed is the IP of your device.).

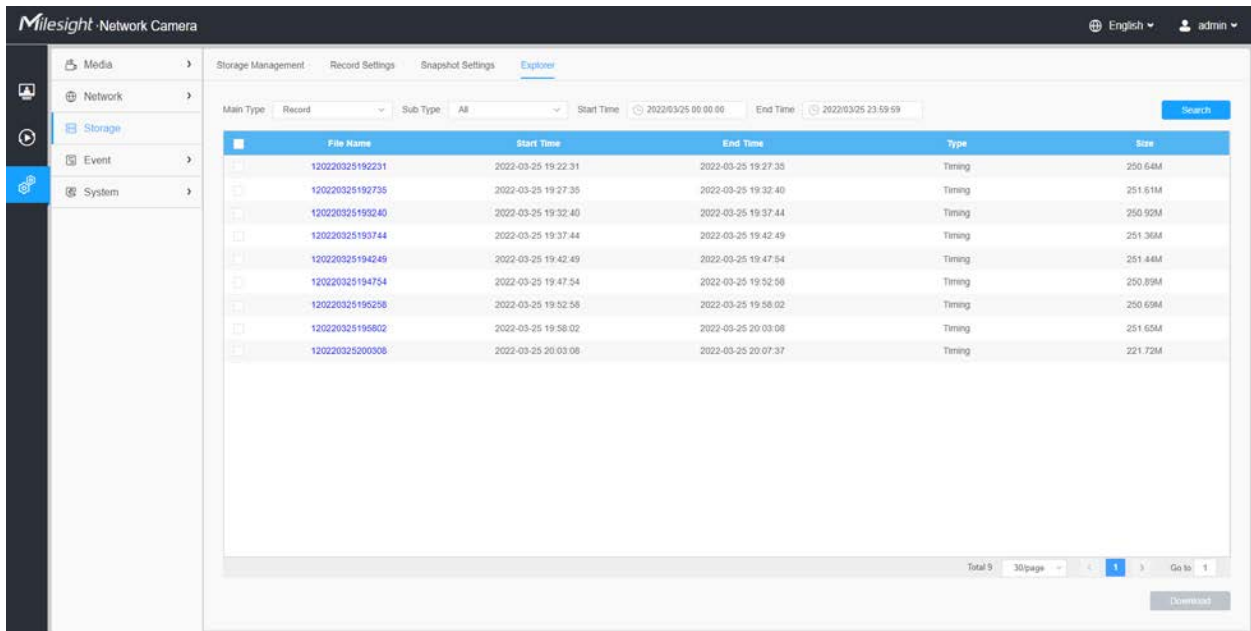

The screenshot shows the 'Explorer' view of the MileSight Network Camera web interface. The interface includes a sidebar with navigation options (Media, Network, Storage, Event, System) and a main content area. The main area displays a table of recorded files with the following columns: File Name, Start Time, End Time, Type, and Size. The table contains 9 rows of data, all of which are 'Timing' type files recorded on 2022-03-25. The file names are unique identifiers, and the start and end times are in HH:MM:SS format. The sizes range from 221.72M to 250.64M. At the bottom of the table, there is a pagination control showing 'Total 9', '30/page', and 'Go to 1'. A 'Download' button is also visible at the bottom right of the table area.

File Name	Start Time	End Time	Type	Size
120220325192231	2022-03-25 19:22:31	2022-03-25 19:27:35	Timing	250.64M
120220325192735	2022-03-25 19:27:35	2022-03-25 19:32:40	Timing	251.51M
120220325193240	2022-03-25 19:32:40	2022-03-25 19:37:44	Timing	250.92M
120220325193744	2022-03-25 19:37:44	2022-03-25 19:42:49	Timing	251.36M
120220325194249	2022-03-25 19:42:49	2022-03-25 19:47:54	Timing	251.44M
120220325194754	2022-03-25 19:47:54	2022-03-25 19:52:58	Timing	250.89M
120220325195258	2022-03-25 19:52:58	2022-03-25 19:58:02	Timing	250.69M
120220325195802	2022-03-25 19:58:02	2022-03-25 20:03:08	Timing	251.65M
120220325200308	2022-03-25 20:03:08	2022-03-25 20:07:37	Timing	221.72M

3.7.4 Event

Basic Event

Motion Detection

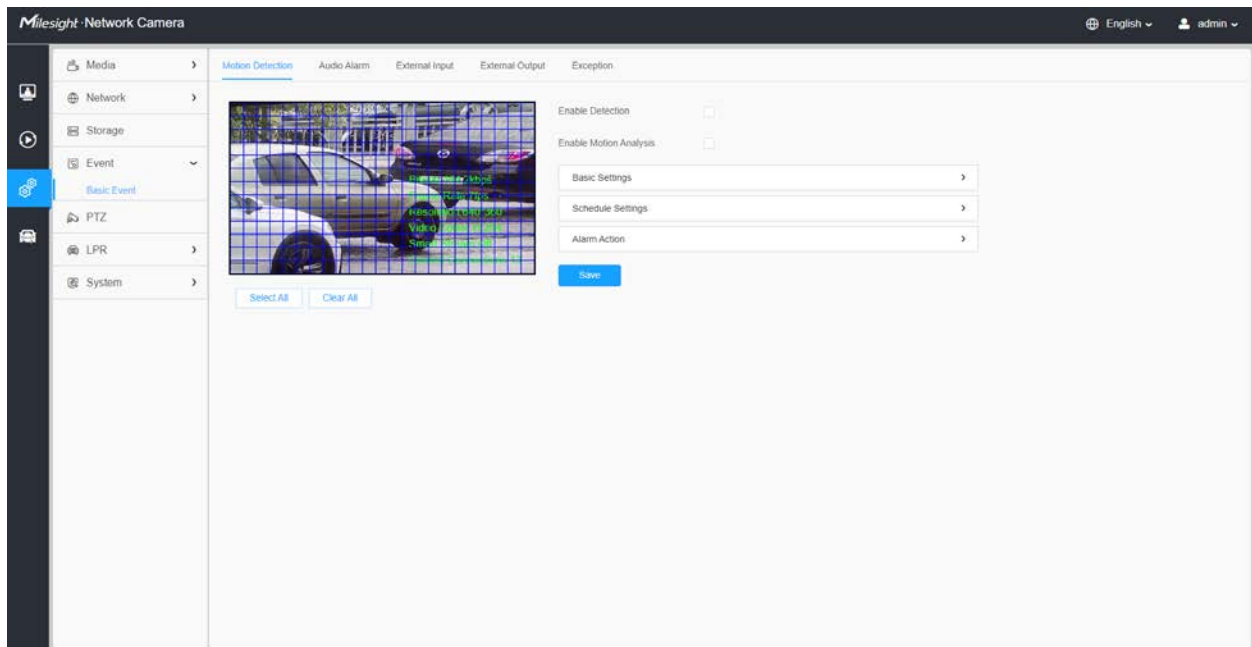

Note: For more details about how to set motion detection, please refer to <https://milesight.freshdesk.com/a/solutions/articles/69000643423>.

Settings steps are shown as follows:

Step1: Check the checkbox to enable the motion detection.

Step2: Check the check box to enable the motion analysis.

Step3: Select the detection mode;

Step4: Set motion region;

Table 110. Description of the buttons

Parameters	Function Introduction
Enable Detection	Check the checkbox to enable Motion Detection function.

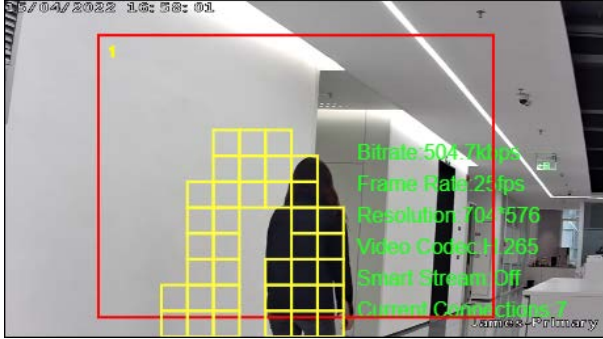
Parameters	Function Introduction
<p data-bbox="269 527 526 552">Enable Motion Analysis</p>	<p data-bbox="615 302 1419 359">When Motion Analysis is enabled, the moving region will turn yellow so that the user can know exactly where the motion occurred.</p> <p data-bbox="615 380 1240 407"> Note: Only support when HTTP is selected in Live View.</p> 
<p data-bbox="350 846 448 871">Select All</p>	<p data-bbox="615 846 1179 873">Click the button, the motion in the area will be detected.</p>
<p data-bbox="350 940 448 966">Clear All</p>	<p data-bbox="615 940 1182 968">Click the button, the area drawn before will be removed.</p>
<p data-bbox="370 1031 428 1056">Save</p>	<p data-bbox="615 1031 850 1058">Save the configuration.</p>

[Basic Settings]

Enable Detection

Enable Motion Analysis

Basic Settings ▾

Mode Normal Mode Advanced Mode

Sensitivity 9

Onvif Motion ActiveCells Settings

Schedule Settings >

Alarm Action >

Save

Table 111. Description of the buttons

Parameters	Function Introduction
Detection Mode	Normal Mode and Advanced Mode are available for the option. When Advanced Mode is selected, users can configure up to 4 detection regions and sensitivity for each detection region.
Sensitivity	Sensitivity level, 1~10
Onvif Motion ActiveCells Settings	Normal and Compatible are available for the option. If the setting of motion region of the third-party software is different from ours, please set this option to Compatible

[Schedule Settings]

Step5: Set motion detection schedule;

Enable Detection

Enable Motion Analysis

Basic Settings >

Schedule Settings v

0 2 4 6 8 10 12 14 16 18 20 22 24

Sun.

Mon.

Tue.

Wed.

Thu.

Fri.

Sat.

Select All Clear All

Alarm Action >

Save

Table 112. Description of the buttons

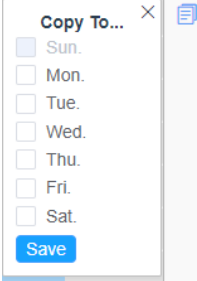
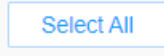
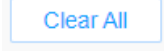
Parameters	Function Introduction
	<p>Copy the schedule area to another date.</p>
	<p>Select all schedule.</p>
	<p>Clear all schedule.</p>

[Alarm Action]

Step6: Set alarm action;

Enable Detection

Enable Motion Analysis

Basic Settings >

Schedule Settings >

Alarm Action ▾

Record >

Snapshot >

External Output >





Play Audio (Please enable the Audio Speaker.)

Alarm to SIP Phone (Please open the SIP.)

HTTP Notification >

Save

Table 113. Description of the buttons

Parameters	Function Introduction
Record	<p>Duration: Selected the duration time of alarm. 5s/10s/15s/20s/25s/30s are available.</p> <p>Linkage: Save alarm recording files into SD Card or NAS or Upload the recording files via FTP.</p>
Snapshot	<p>Number: The number of snapshot, 1~5 are available.</p> <p>Interval: This cannot be edited unless you choose more than 1 to Snapshot.</p> <p>Linkage: Save alarm recording files into SD Card or NAS, Upload the recording files via FTP and send alarm email.</p>
External Output	If the camera equips with External Output, you can enable the action after configuring the trigger duration.
Play Audio	<p>Auto/10 seconds/30 seconds/1 minute/5 minutes/10 minutes are available.</p> <p> Note: Please enable the Audio Speaker.</p>
Alarm to SIP Phone	Support to call the SIP phone after enable the SIP function.
HTTP Notification	<p>Support to pop up the alarm news to specified HTTP URL.</p> <p> Note:</p> <ul style="list-style-type: none"> • Three HTTP notifications at most can be added to the same event. • HTTP Notification supports Basic & Digest authentication
White LED	<p>When the alarm triggered, White LED will turn on to warn the detected objects.</p> <p> Note: Only for PTZ Bullet.</p>
PTZ Motion	<p>When the motion alarm triggered, PTZ Motion allows the camera move the lens to the motion triggered position and zoom in.</p> <p> Note: Only for PTZ series.</p>
Call Preset/ Call Patrol/Call Pattern (Only for External Input)	<p>When the motion alarm triggered, the specified preset/patrol/pattern can be called.</p> <p> Note: Only for PTZ series.</p>

Audio Alarm

Check the check box to enable the Audio Alarm function.

 **Note:** Enable the Audio Mic before using Audio Alarm function.

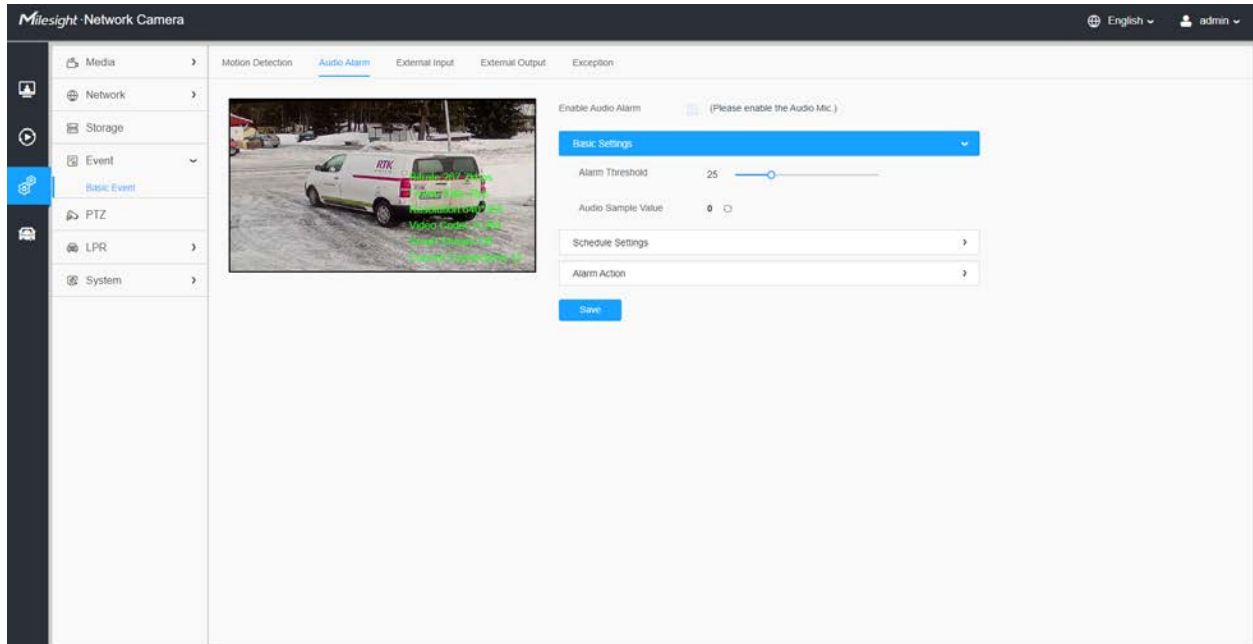

[Basic Settings]

Table 114. Description of the buttons

Parameters	Function Introduction
Alarm Threshold	Audio Alarm will be triggered when the thresholds reaches to a certain value from 0 to 100.
Audio Sample Value	The current value of the audio sample.

[Schedule Settings]

Refer to the table [Table 3 \(page 85\)](#) for the meanings of the items, here will not repeat again.

[Alarm Action]

Refer to the table [Table 4 \(page 86\)](#) for the meanings of the items, here will not repeat again.

External Input

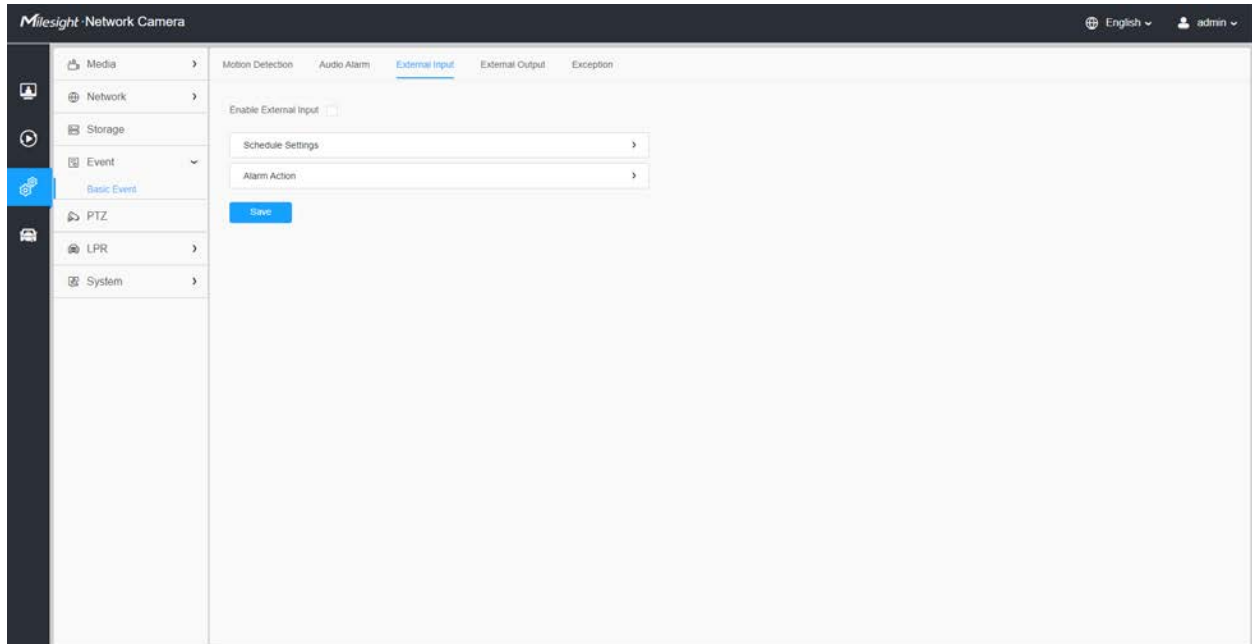

Refer to the table [Table 3 \(page 85\)](#) for the meanings of the items, here will not repeat again.

External Output

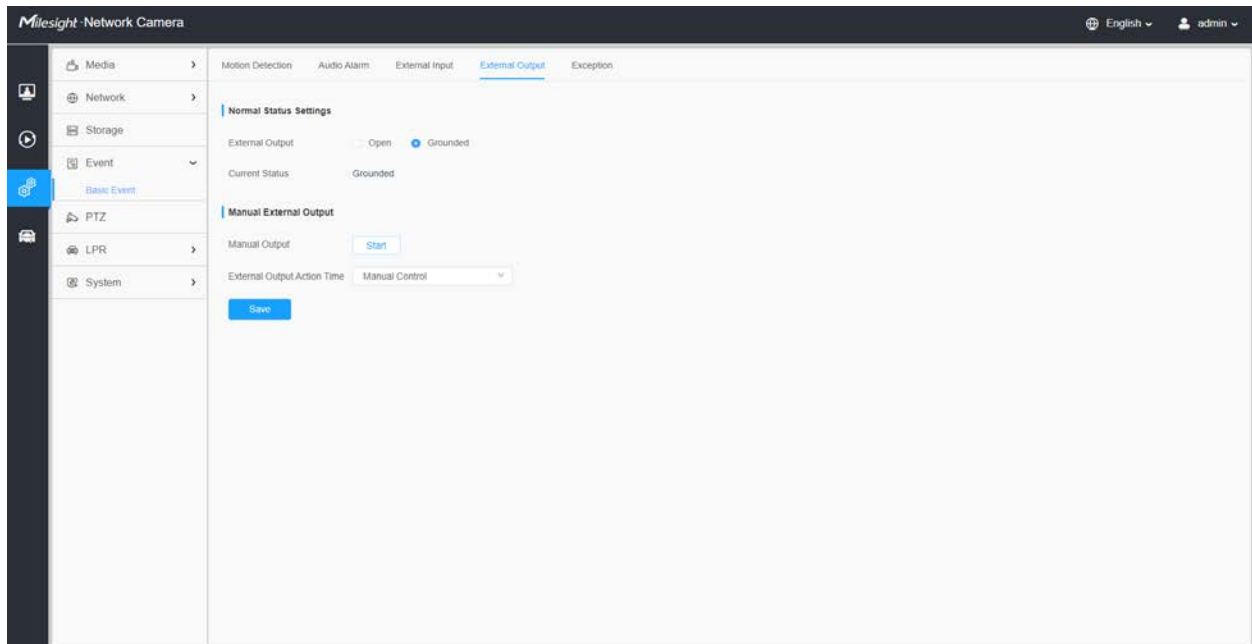

[Normal Status Settings]

Please set the **Normal Status** firstly, when the **Current Status** is different with **Normal Status**, it will lead to the alarm.

[Manual External Output]

You can set the manual external output.

Table 115. Description of the buttons

Parameters	Function Introduction
Manual Output	Click to Start/Stop manual external output.
External Output Action Time	Manual Control/Customize/10 s/1 min./5 min./10 min. are available.

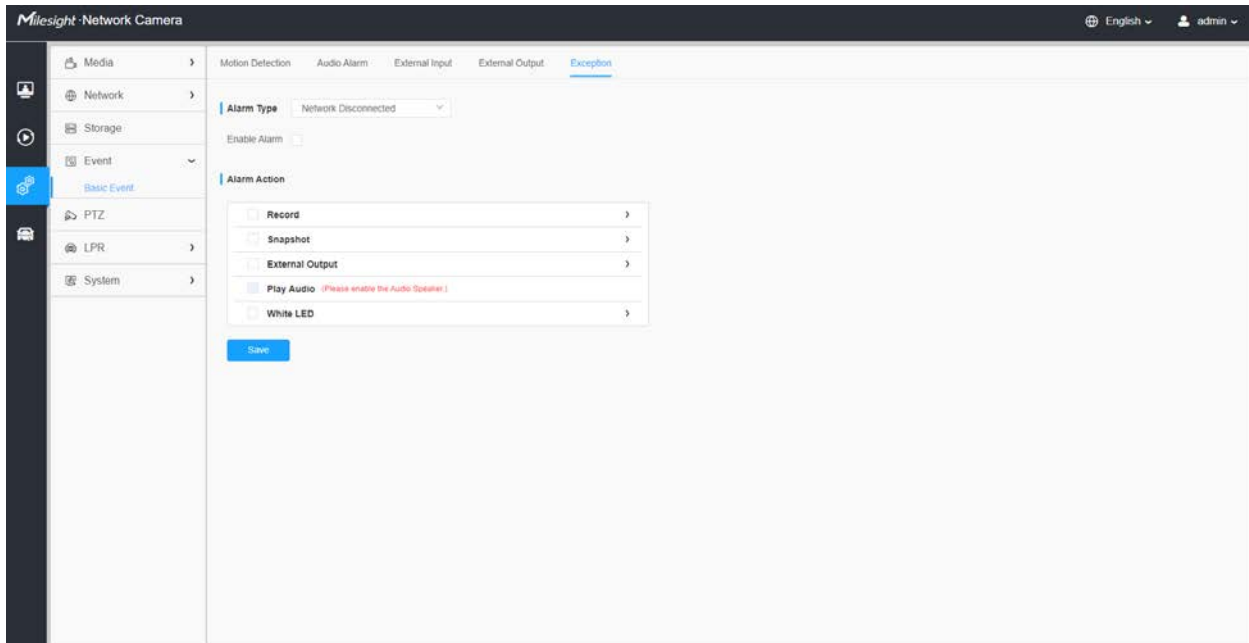
Exception**Table 116. Description of the buttons**

Parameters	Function Introduction
Alarm Type	Network Disconnected, IP Address Conflicted, Record Failed, SD Card Full, SD Card Uninitialized, SD Card Error and No SD Card are available Check the checkbox to enable the alarm type you selected
Alarm Action	Refer to the table Table 3 (page 85) for the meanings of the items, here will not repeat again.

PTZ

PTZ Settings provides you to configure the functions and parameters about Pan/Tilt/Zoom.

PTZ parameters are mainly include the Basic parameters, Auto Home, PTZ Limits, Initial Position(PTZ Bullet), Privacy Mask, Scheduled Tasks, Config Clear, RS485(Speed Dome), Wiper(Speed Dome).

Basic

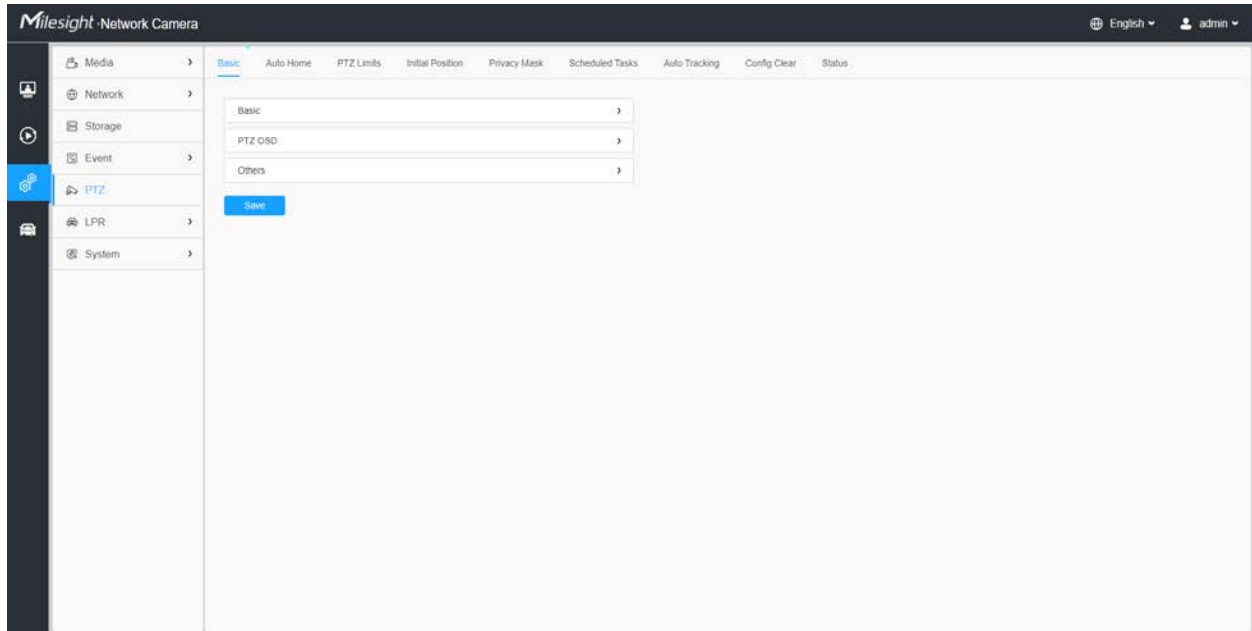

[Basic]

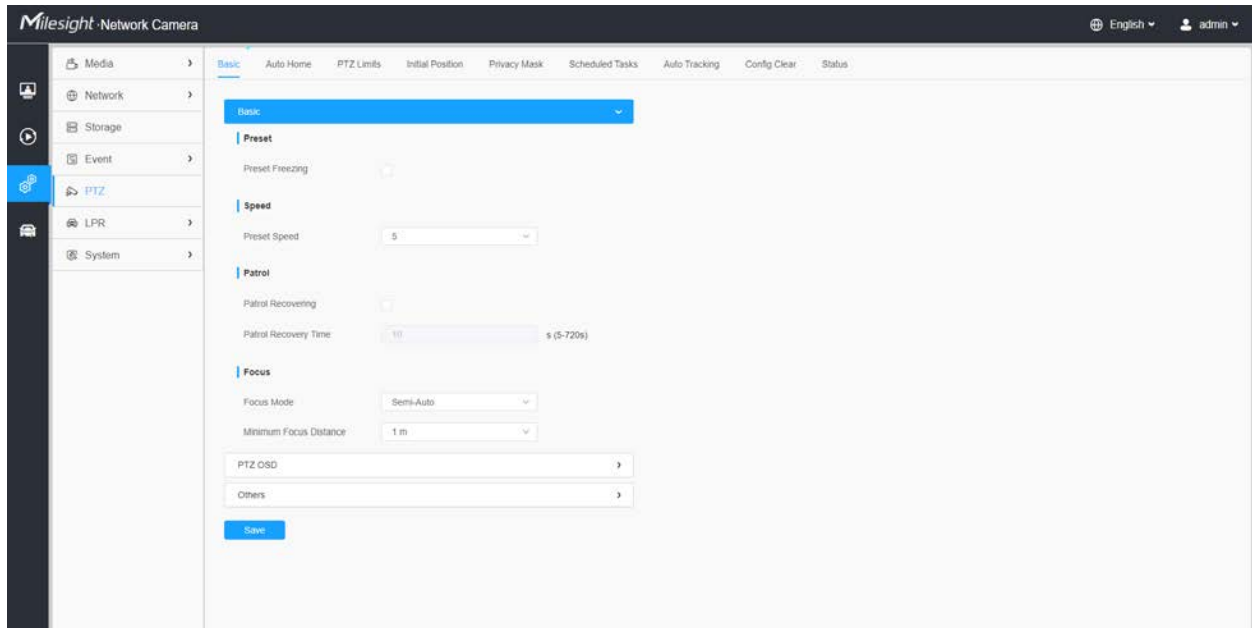



Table 117. Description of the buttons

Parameters	Function Introduction
Preset	If you enabled Preset Freezing, the live view of preset position will be showed directly instead of showing both the moving path to the position and the live view. It can also reduce the use of bandwidth in the digital network system.
Speed	Preset Speed: It determines the speed of calling presets. Level 1~10 are available.
	Manual Speed: It determines the PTZ speed of Manually control. Low/ Medium/ High are available.  Note: Only for Speed Dome.
	Scan Speed: It determines the speed of Auto Scan. Level 1~10 are available.  Note: Only for Speed Dome.
Patrol	Patrol Recovering: Click to enable Patrol Recovering.
	Patrol Recovery Time: Set time for Patrol Recovering, which is between 5 to 720 seconds.
Focus	Focus Mode: Three focus modes are available: Auto/ Semi-Auto/ Manual.
	Minimum Focus Distance: Set the minimum focus distance to adjust the step length of each focus. 1 meter, 1.5 meters, 3 meters, 6 meters, 10 meters and 20 meters are available. The default minimum focus distance is 1 meter.

[PTZ OSD]

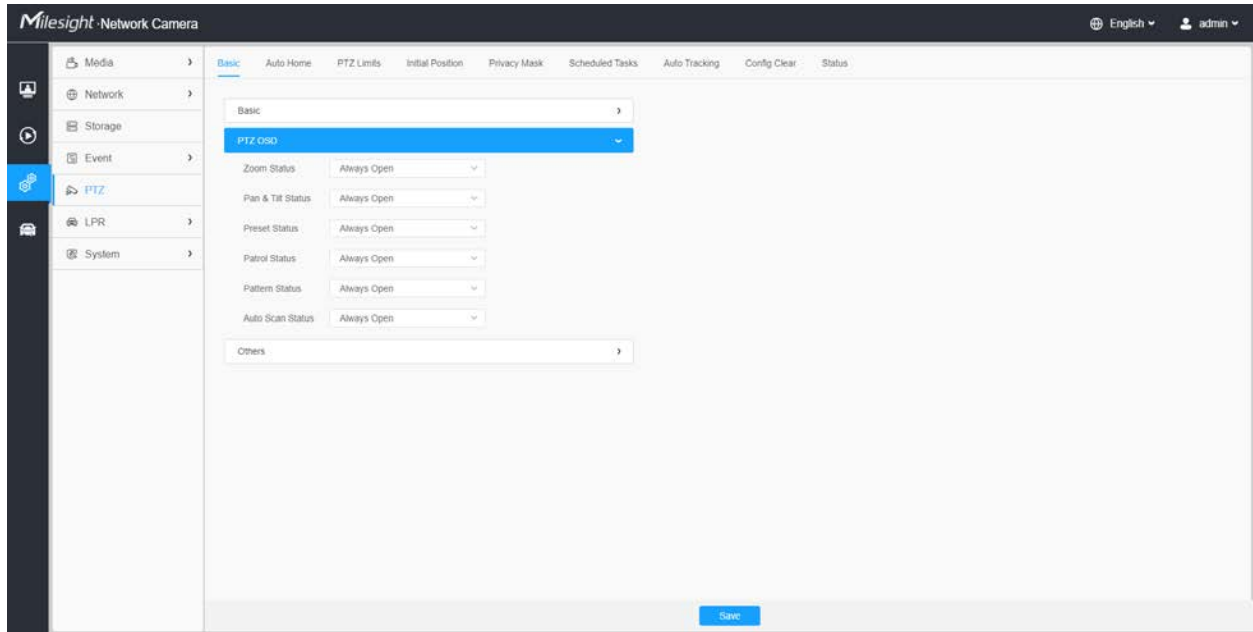

Table 118. Description of the buttons

Parameters	Function Introduction
Zoom Status	2s/ 5s/ 10s/Always Open/ Always Close are available.
Pan & Tilt Status	2s/ 5s/ 10s/Always Open/ Always Close are available.
Preset Status	2s/ 5s/ 10s/Always Open/ Always Close are available.
Patrol Status	Always Open/ Always Close are available.
Pattern Status	Always Open/ Always Close are available.
Auto Scan Status	Always Open/ Always Close are available.

[Others]

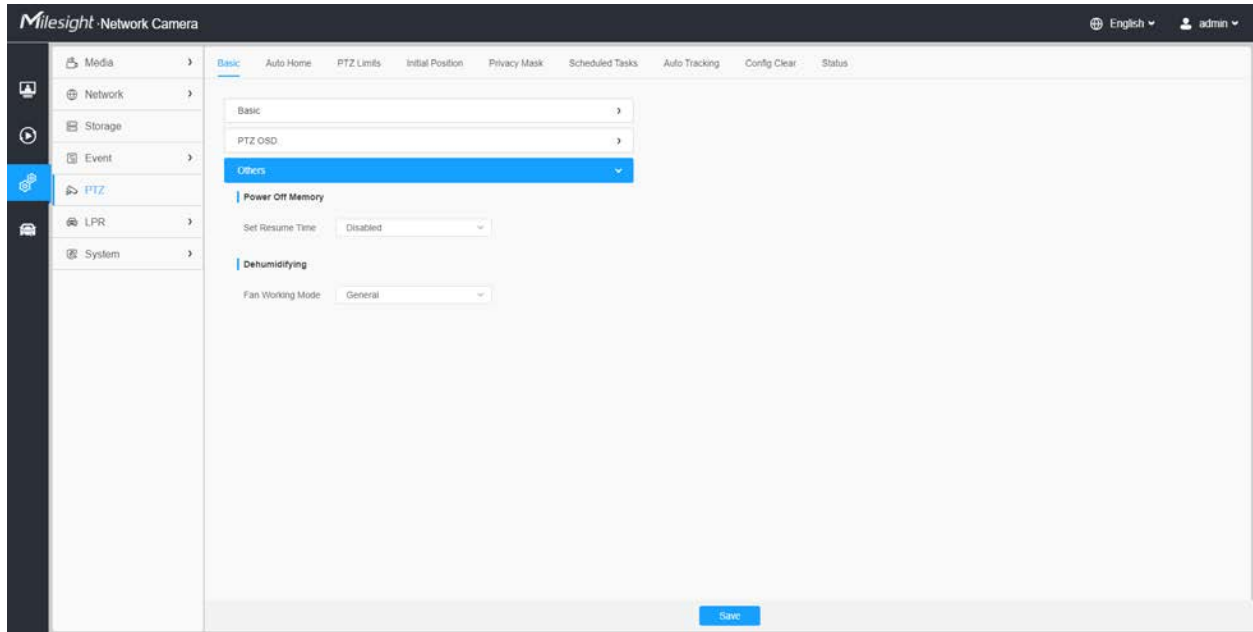
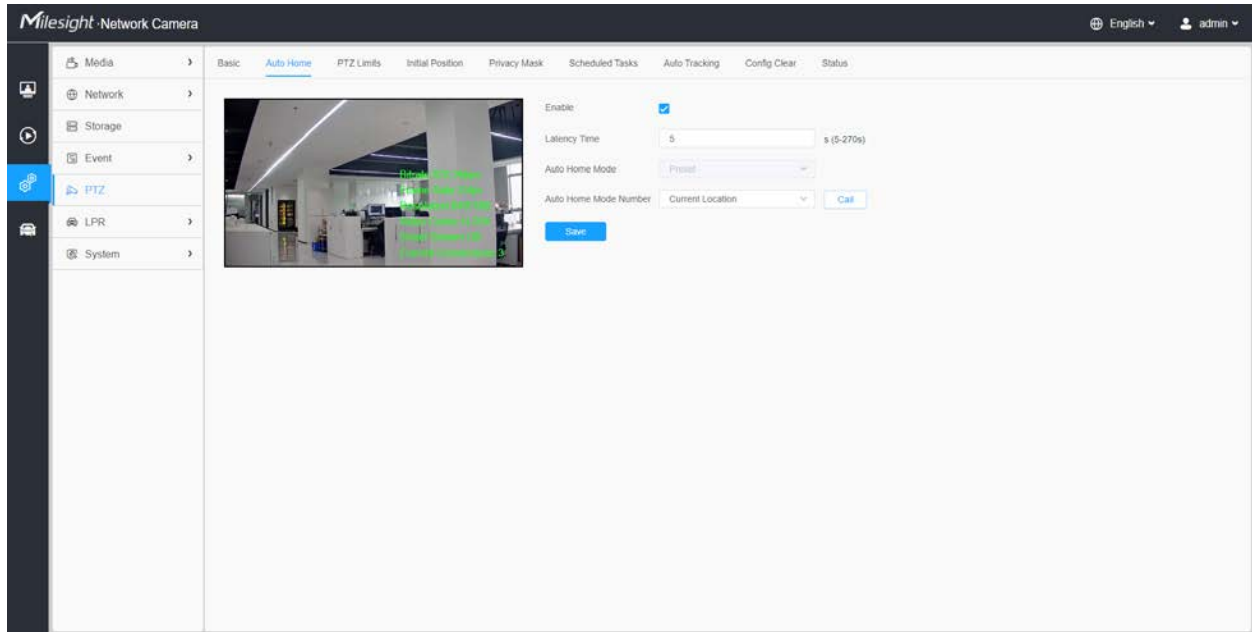

Table 119. Description of the buttons

Parameters	Function Introduction
<p>Power Off Memory</p>	<p>If the camera stop working for a longer time than predefined, the position of it will be recorded. And it will resume to the position after going back to the normal work from power off.</p> <p>You can set the resume time to 30 seconds, 60 seconds, 300 seconds or 600 seconds to record its position.</p>
<p>Dehumidifying</p>	<p>Fan Working Mode: Three fan working modes are available: General/ Enhancement/ Constant.</p> <p>General: The fans are turned on from 4am to 7am and 5pm to 8pm every day.</p> <p>Enhancement: The fans are turned on from 5pm to 7am every day.</p> <p>Constant: The fans work 24 hours a day.</p>

Auto Home



Auto Home allows the PTZ camera to return to a predefined Home Position automatically after a period of latency time. Check the checkbox to enable the Auto Home mode.

Table 120. Description of the buttons

Parameters	Function Introduction
Enable	Enable/disable the auto home function.
Latency Time	Set a latency time to trigger Auto Home mode, 5-720s.
Auto Home Mode	Preset: A preset point will take effect when triggering the Auto Home.
Auto Home Mode Number	Select a predefined preset in the list, press "Call" to check the location. Also support to select current location.

PTZ Limits

The PTZ camera can be programmed to move within the configurable PTZ Limits (Left/Right).

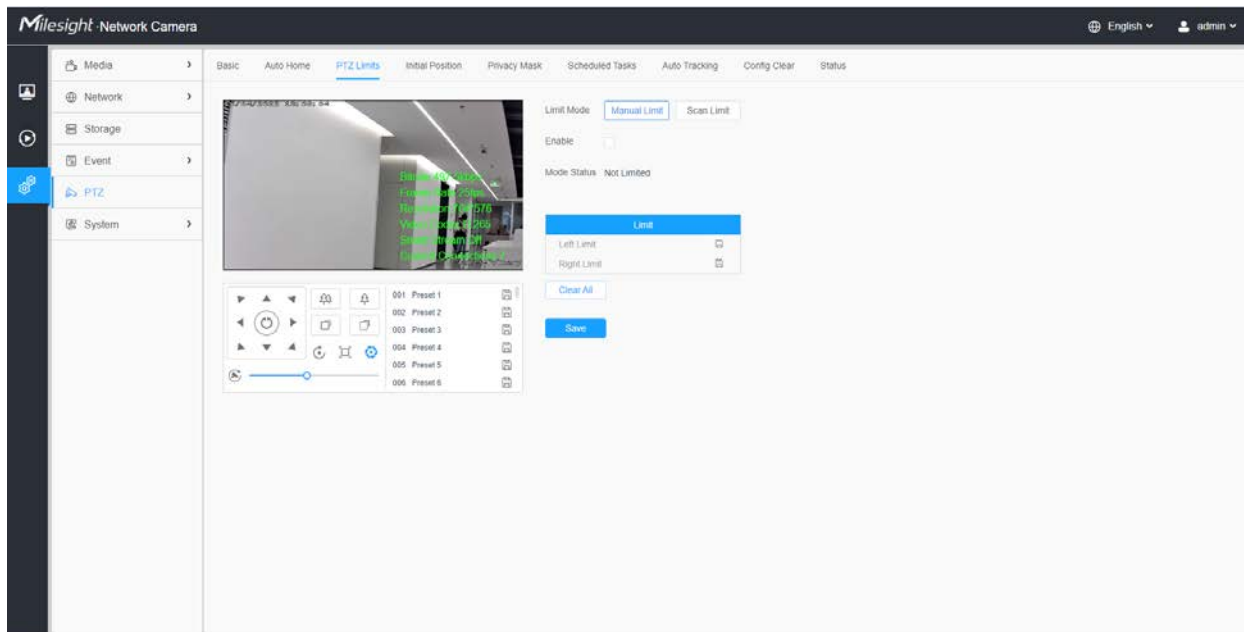

Step1: Check the checkbox to enable the PTZ Limit function.

Step2: Choose the limit mode as Manual limit or scanning limit.

- Manual Limit:

When Manual limit stops are set, you can operate the PTZ control panel manually only in the limited surveillance area.

- Scan Limit:

When Scan limit stops are set, the auto scan is performed only in the limited surveillance area.

Step3: Click the PTZ controller buttons to set the left/right limit stops; you can also call the defined presets and set them as the limits of the PTZ camera.

Step4: Click **Set** to save the limits or **Clear** to clear the limits.

Initial Position

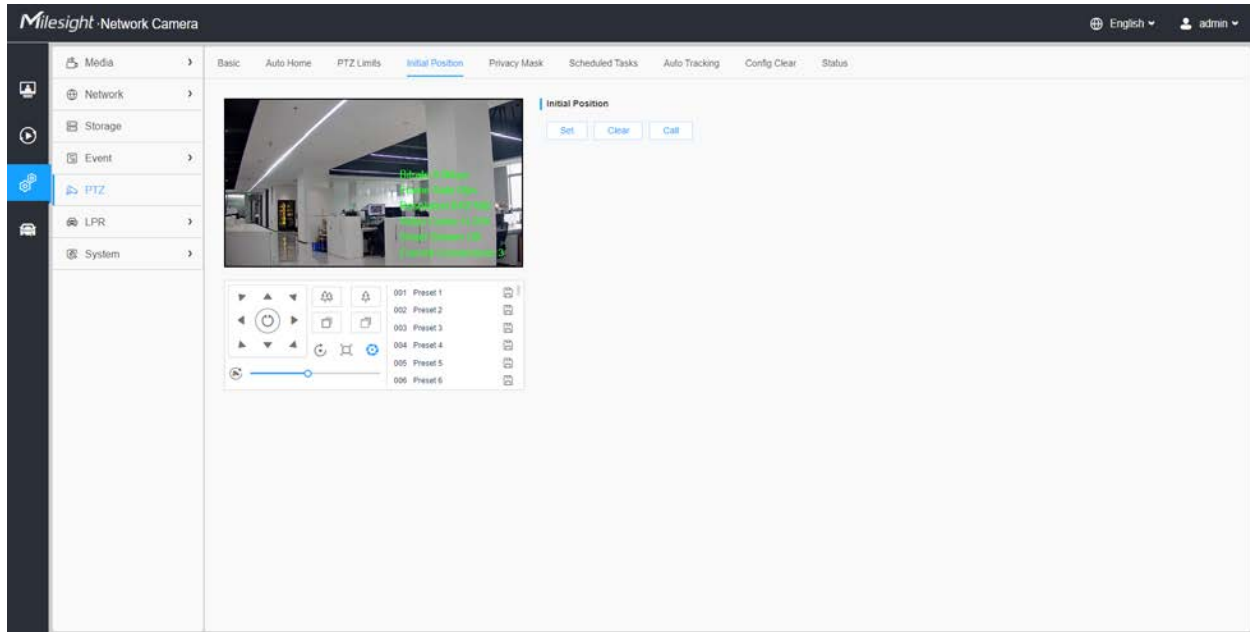

You can configure the Initial Position for PTZ cameras as a zero point.

Step1: Click the PTZ control buttons as the Initial Position of the PTZ bullet, you can also call a defined preset and set it as the Initial Position.

Step2: Click Set to save the position as the Initial Position.

Table 121. Description of the buttons

Parameters	Function Introduction
Set	Click to set the current position as a Initial Position
Clear	Clear the Initial Position to default settings.
Call	Click to call the Initial Position.

Privacy Mask

Privacy mask enables to cover certain areas on the live video to prevent certain spots in the surveillance area from being viewed and recorded. The mask area does not move as the lens moves.

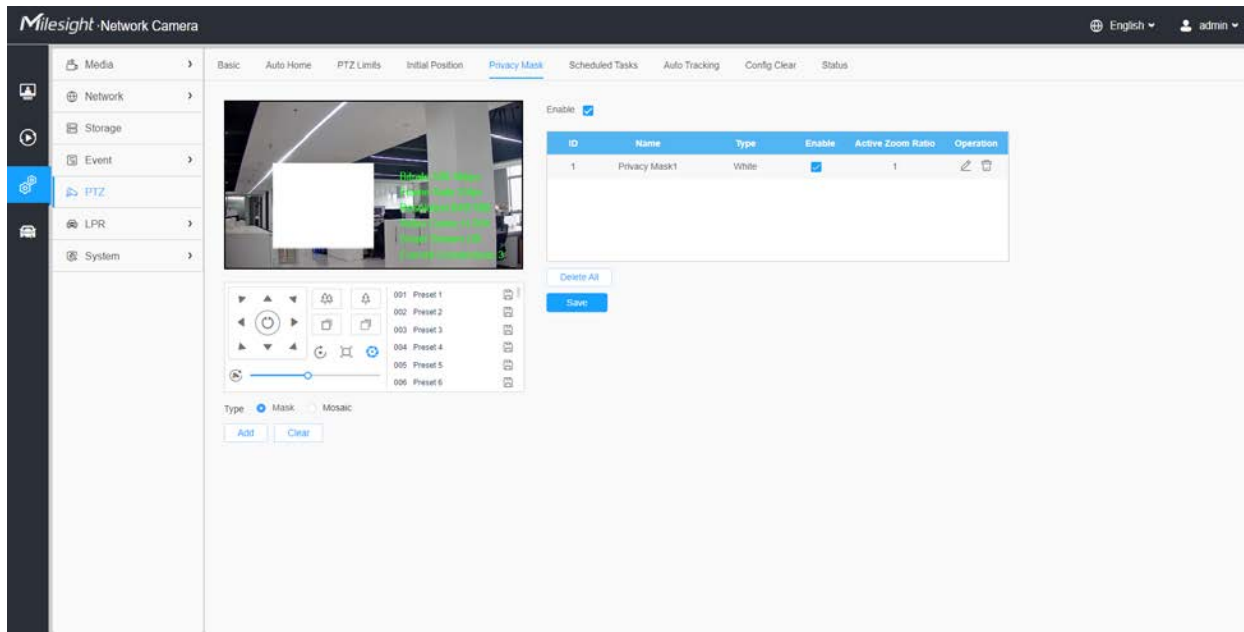

You can select the color type and mosaic type to use for the cover certain areas on the live video. The mosaic type can maintain the continuity of the picture and improve the visual effect. Up to 28 mask areas are supported, which includes 24 mask areas and 4 mosaic areas.

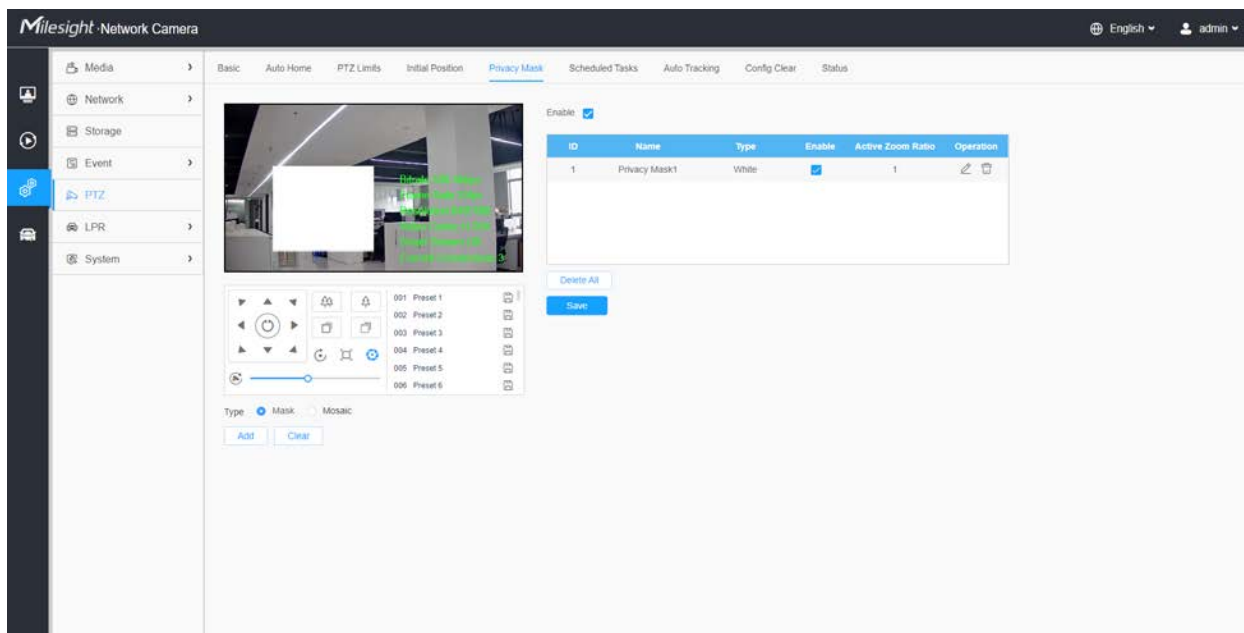
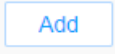
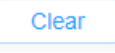





Table 122. Description of the buttons

Parameters	Function Introduction
Enable	Check the check box to enable the Privacy Mask function.

Parameters	Function Introduction	
Type	Select the type to use for the privacy areas, there are two types available: Mask and Mosaic.	
	Draw a privacy area on the live video as needed.	
	Clear the area you drew on the live video.	
Operation		Enable/disable the selected ROI areas.
		Change the color of Mask area, there are eight colors available: White, Black, Blue, Yellow, Green, Brown, Red and Violet
		Delete the privacy mask area

Schedule Tasks

You can configure the PTZ camera to perform a certain action automatically in a user-defined time period.

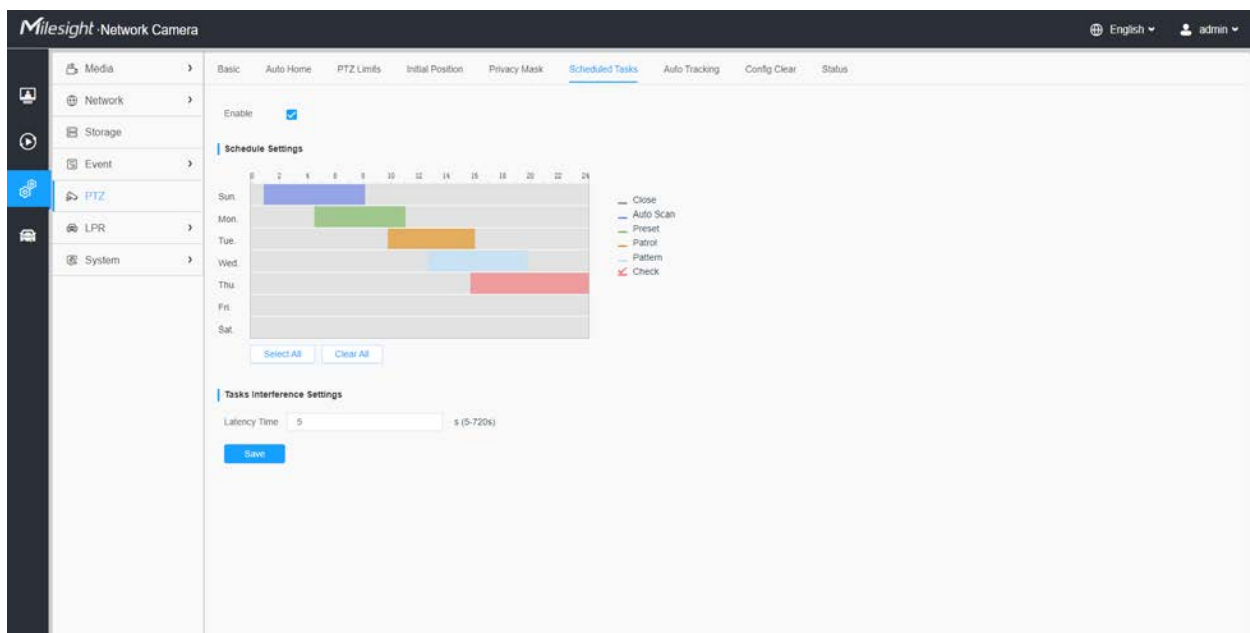

Step1: Enter the Scheduled Task Settings interface:

Step2: Check the check box to Enable Scheduled Task.

Step3: Set the schedule and task details.

Step4: Set the Task Recovery Time (from 5 to 720 seconds). You can set the time(a period of inactivity) before the PTZ camera starts the schedule and task details.

Step5: Click  button to save all the configurations.

Note:

- The time of each task cannot be overlapped. Up to 10 tasks can be configured for each day.
- The Scheduled Tasks function is prior to Auto Home function. When these two functions are set at the same time, only the Scheduled Tasks function takes effect.
- You can click button to select or close all schedule of different kinds of tasks.

Config Clear

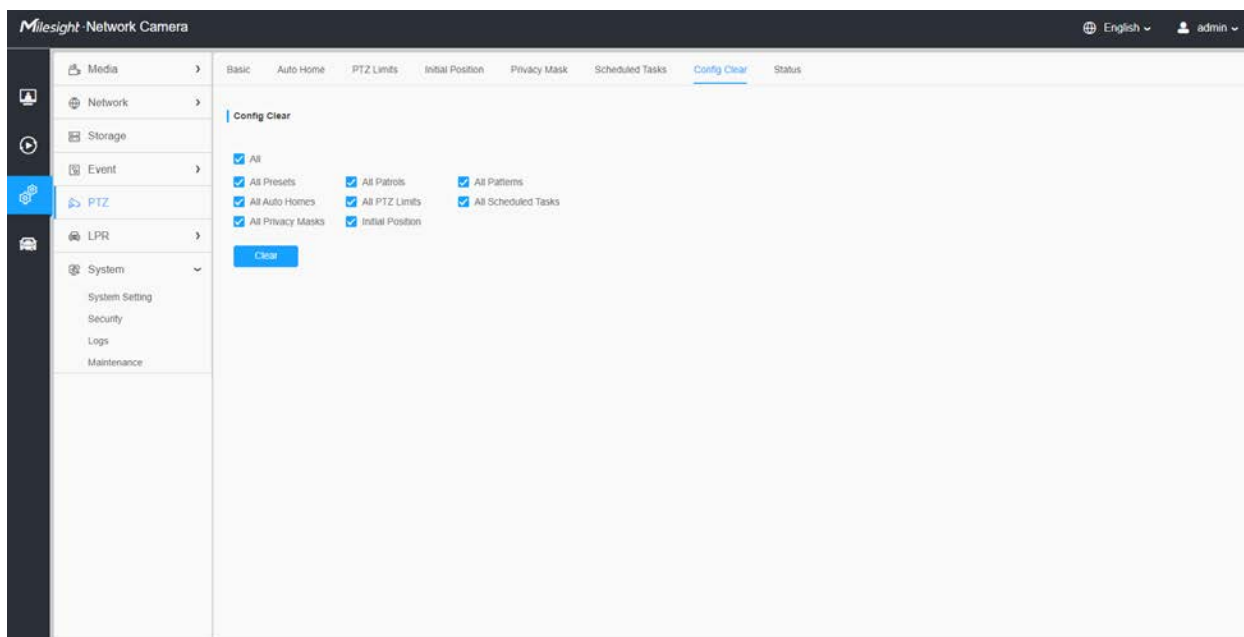

Here you can clear PTZ configurations, including all PTZ configurations, Presets, Patrols, Patterns, Auto Homes, PTZ Limits , Initial Position (PTZ Bullet), Privacy Masks and Scheduled Tasks.

RS485

Here you can clear configure RS485 serial port to control the PTZ of Speed Dome. Protocol, Baudrate, Data Bit, Stop Bit, Parity, Flow Control, PTZ Address should be exactly the same as those of the control device.

 **Note:** This function is only for Speed Dome.

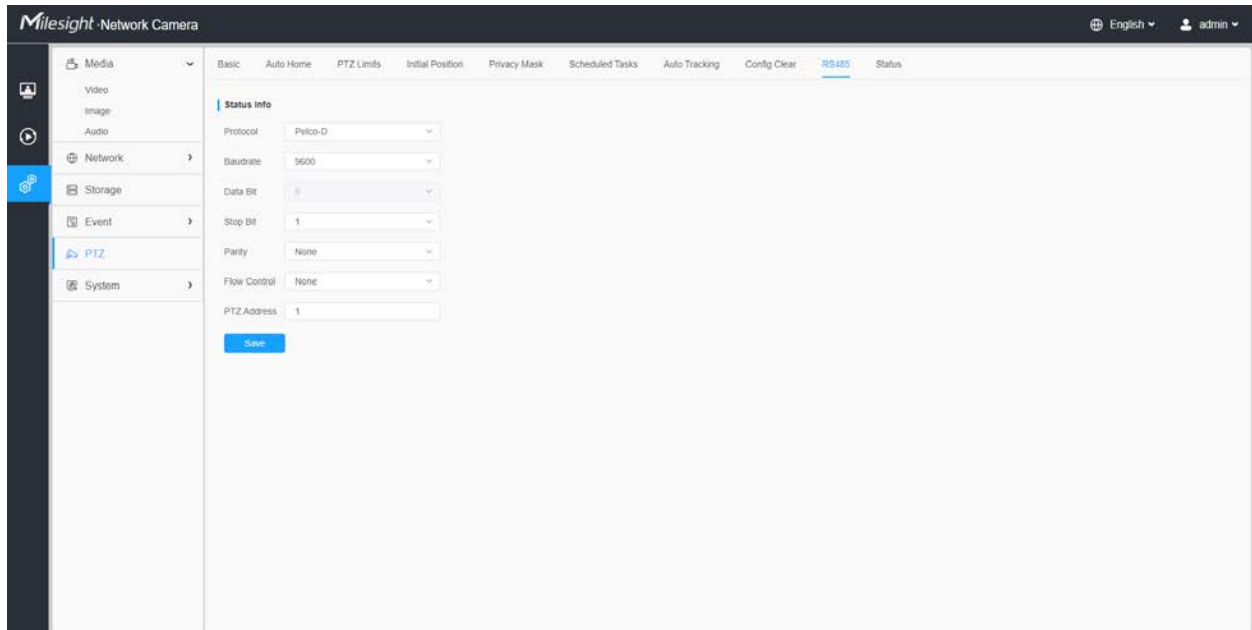

Wiper

Users can enable the wiper function in this interface, it will detect the rainwater through the rain gauge smart sensor, and then start the wiper to automatically wipe twice to clean the lens and get a clearer view. The wiper supports two different speeds(75°/s and 95°/s) depending on the rain.

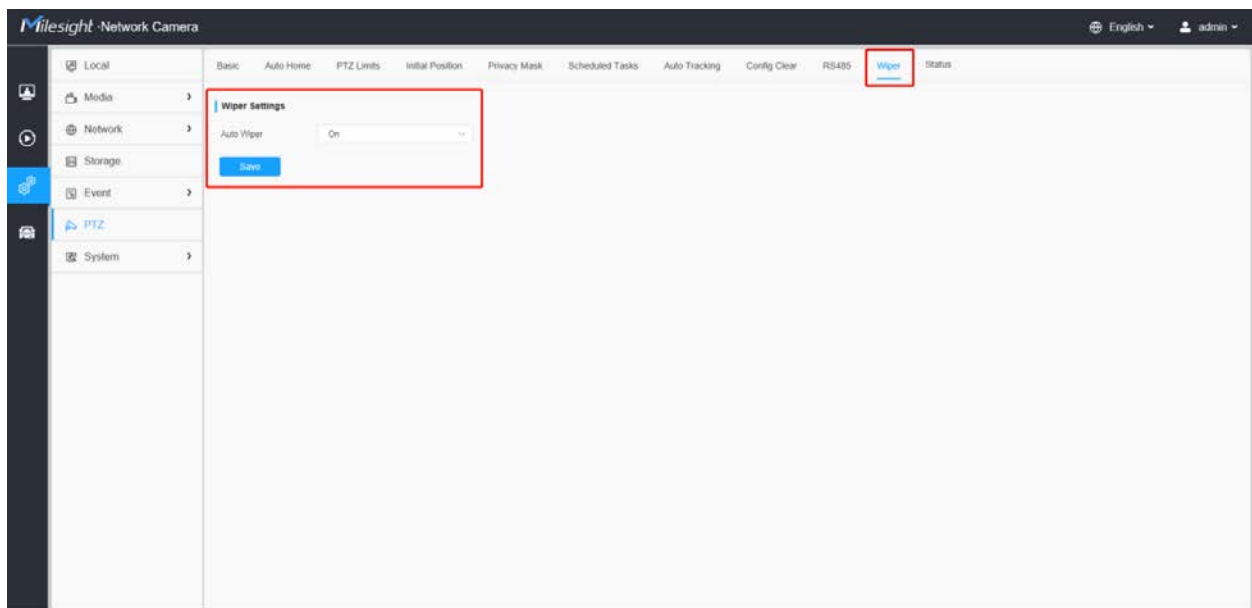

In the live view interface, it also supports manually enabling the wiper to wipe twice by clicking the wiper button or directly calling the preset 53.

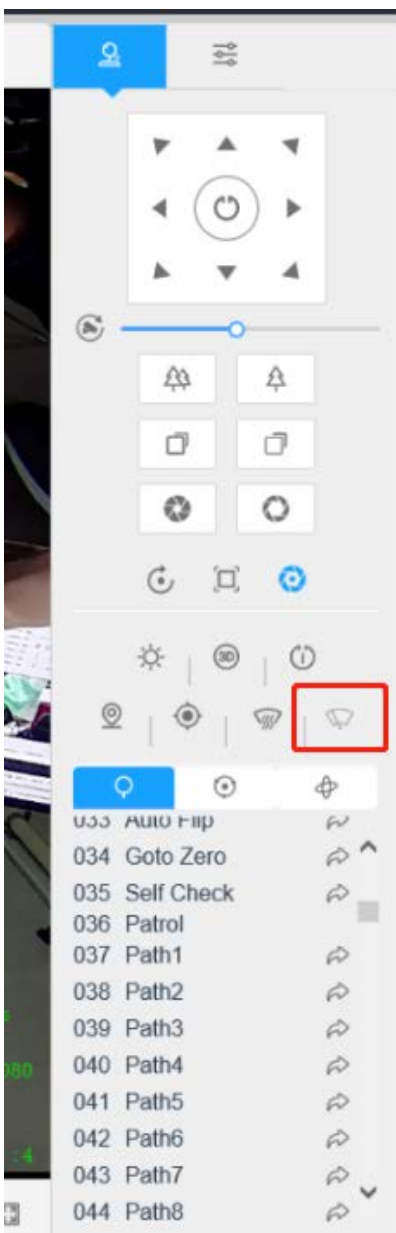

Note:

- When the wiper is working, other events can be triggered normally except the motion detection function.
- When the wiper is working, the Day/Night Mode can be switched normally.

Status

Here you can see the status information for PTZ camera, including temperature and fan status.

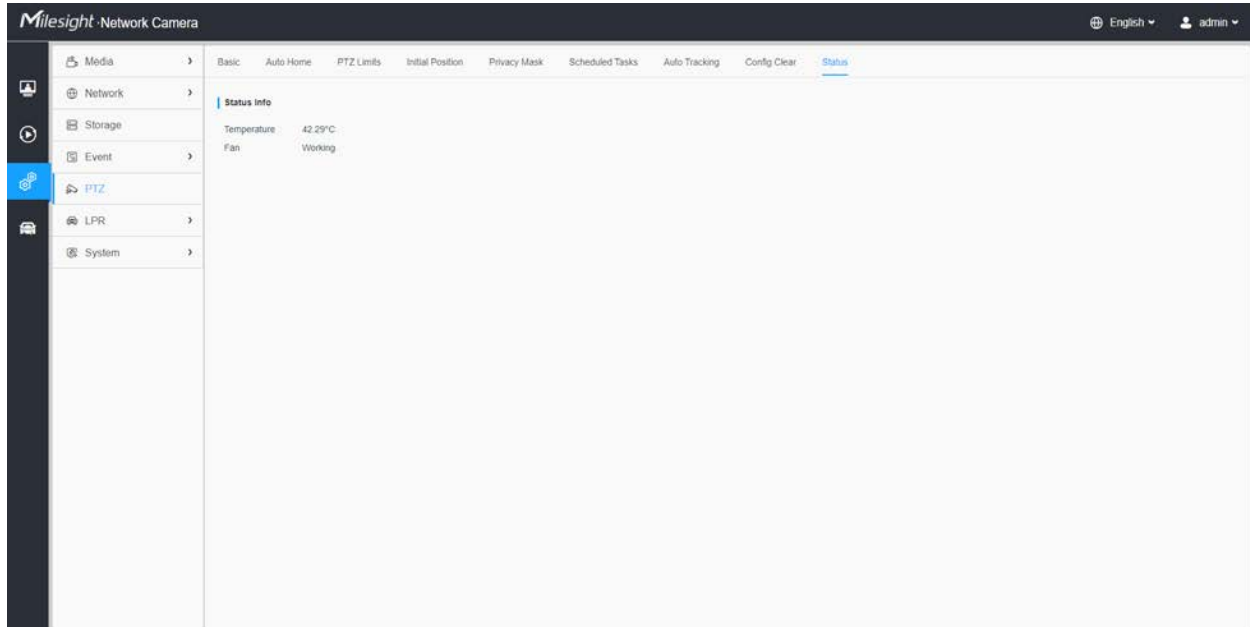

3.7.5 LPR

Settings

The LPR function will automatically detect and capture license plate in real time and compares to a predefined list, then takes appropriate action such as generating an alert once the license plate is on the predefined black list.

Currently we have several LPR versions, **LPR1, LPR2, LPR3, LPR 4, LPR EU, LPR AP, LPR AM and LPR_ME**. LPR_EU, LPR2 are for European. LPR1 and LPR_AP are for Asia&Pacific. LPR4 and LPR_AM are for America. LPR3 is for Korea. LPR_ME is for Middle East.

Before you start, please enter a license to activate the LPR function on System info interface. When the License Status changes to Valid, the camera can start detecting the license plates.

Note:

- The LPR1 version does not require a license.

- For more details about how to set ANPR solution, please refer to <https://milesight.freshdesk.com/a/solutions/articles/69000640021>.
- For more details about how to set LPR1, please refer to <https://milesight.freshdesk.com/a/solutions/articles/69000797908>.
- For more details about how to set LPR2, please refer to <https://milesight.freshdesk.com/a/solutions/articles/69000797905>.
- For more details about how to set LPR3, please refer to <https://milesight.freshdesk.com/a/solutions/articles/69000797904>.

General

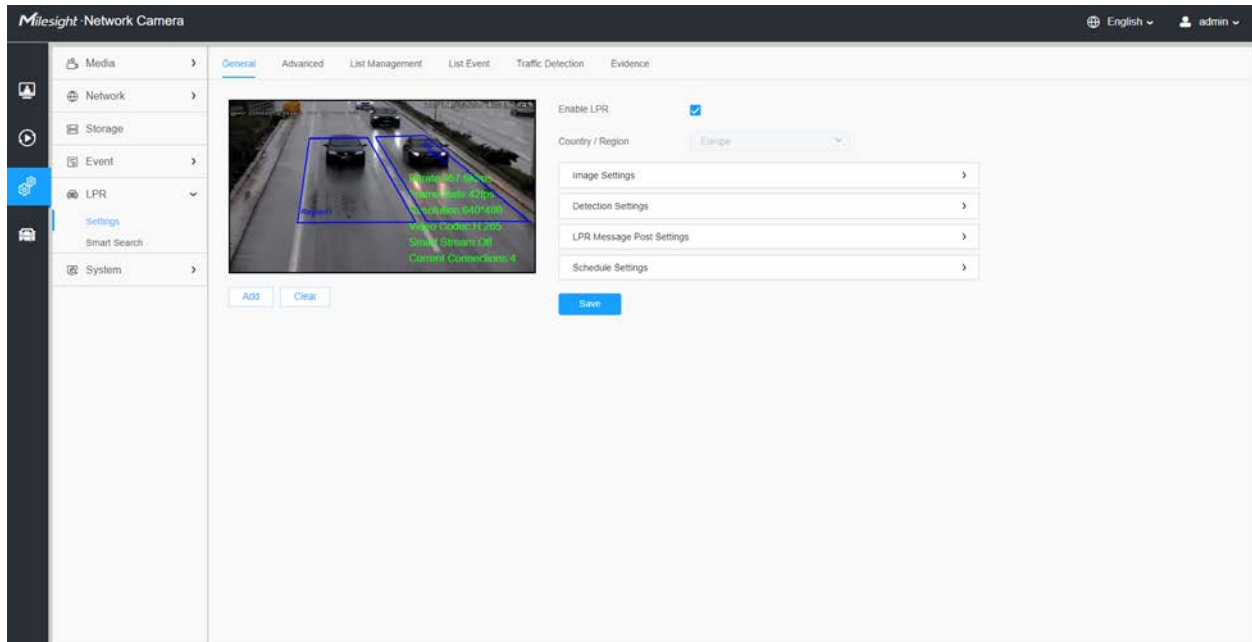

Table 123. Description of the buttons

Parameters	Function Introduction
Enable Detection	Enable/disable the LPR detection function.
Country/ Region (Only for LPR1, LPR4, LPR_AP and LPR_AM)	Select country/ region to detect the license plate.
Effective Region (Only for PTZ series)	Normal: configure the LPR detection regions for the current area. Advanced: configure different LPR detection regions for different PTZ presets(Only support Preset 1~4 so far).

Step1: Check the check box to enable the LPR detection function. Select country/ region to detect the license plate.

[Image Settings]

Step2: The LPR Night Mode supports the optimal LPR night recognition effect by adjusting different parameter levels. You can choose Customize to set effective time manually, or choose Auto Mode which can automatically switch to night mode according to illumination intensity.

Table 124. Description of the buttons

Parameters	Function Introduction
Enable LPR Image Mode	To enable LPR Image Mode, parameters of Backlight, Exposure and Day/Night Switch will be set to special values.
Level	Level 1~5 are available.  Note: Minimum Shutter of each Level : 1- 1/250, 2- 1/500, 3- 1/750, 4- 1/1000, 5- 1/2000.

[Detection Settings]

Step3: Check the check box “Enable License Plate Recognition”, you can draw the screen to select area interested.

Detection Settings
▼

Detection Region ⓘ

ID	Name	Operation
1	ROI_1	

[Delete All](#)

Detection Settings

Detection Mode Plate Priority Vehicle Priority ⓘ

Detection Trigger ▼

Repeat Plate Checktime ▼ (0-60000)

License Plate Serial Format [Edit](#)

Attributes Identification

All

Plate Color

Vehicle Type

Vehicle Color

Detection Region

Direction

Country / Region

LPR Message Post Settings
›

Schedule Settings
›

[Save](#)

Note: The detection area can be drawn as an irregular quadrilateral, which greatly enhances the scene adaptability.

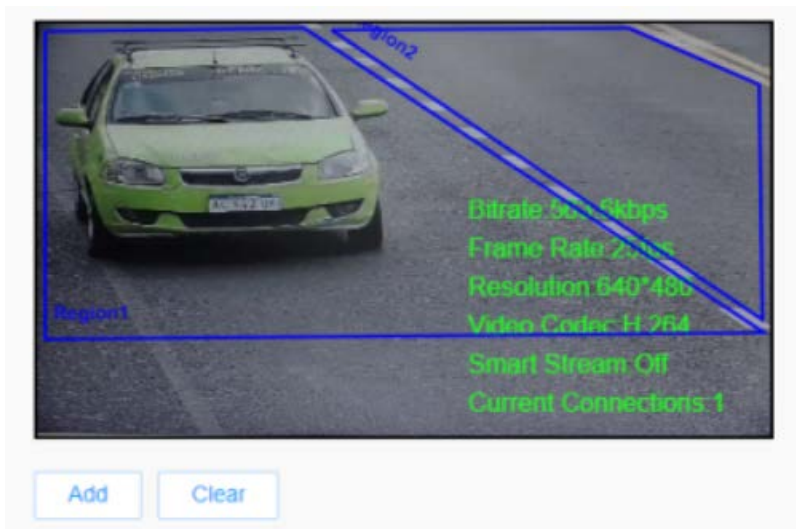



Table 125. Description of the buttons

Parameters	Function Introduction									
Add	<p>Draw the screen to select the area interested, then click “Add” button to add the area, only four recognition areas can be added.</p> <p>You can edit the name of the area or delete the area in the list below.</p> <table border="1"> <thead> <tr> <th>ID</th> <th>Name</th> <th>Operation</th> </tr> </thead> <tbody> <tr> <td>1</td> <td>ROI_1</td> <td> </td> </tr> <tr> <td>2</td> <td>ROI_2</td> <td> </td> </tr> </tbody> </table> <p> Note: Only license plates larger than 150 pixels can be recognized.</p>	ID	Name	Operation	1	ROI_1		2	ROI_2	
ID	Name	Operation								
1	ROI_1									
2	ROI_2									
Clear	Click the "Clear" button to clear the area being drawn.									
Delete All	Click the "Delete All" button to delete all the added areas.									

Step4: Set Detection Settings.

Table 126. Description of the buttons

Parameters	Function Introduction
Detection Mode	<p>Plate Priority: Under this mode, the camera will first recognize the license plate and then locate the target as a vehicle with less delay.</p> <p>Vehicle Priority: Under this mode, the camera will first locate the target vehicle and then recognize the license plate to avoid some false detection.</p> <p> Note: Vehicle priority mode can identify vehicles without license plates.</p>

Parameters	Function Introduction
Processing Resolution (Only for LPR1, LPR2, LPR3 and LPR4)	Resolution of the stream for LPR analysis, including 1920*1280, 1280*720, 640*360, 320*176.
Detection Trigger	<p>Always: in this mode, camera will always detect license plates.</p> <p>Alarm Input: in this mode, camera will only detect license plates during Alarm Input is being triggered.</p>
Confidence Level (Only for LPR1, LPR2, LPR3 and LPR4)	You can set the confidence level from 1 to 10. When the confidence level of the license plate is higher than the set confidence level, it will push the license plate image to the logs interface.
Repeat Plate Checktime	Set the time interval for repeatedly reading license plates to effectively avoid duplicate identification of parking vehicles. You can set Repeat Plate Checktime from 0 to 60min or 0 to 60000ms.
License Plate Serial Format	License Plate Serial Format function supports formulating identification rules and can automatically do further processing, filter license plates in non-compliant formats to achieve more intelligent and accurate license plate recognition.  Note: It supports up to 10 license plate characters.
Attributes Identification	Check Plate Color, Vehicle Type, Vehicle Color, Detection Region, Direction, Country/Region(Only for LPR2 and LPR_EU) , or All to enable Attributes Identification, it will display the corresponding information on the Smart Search interface. <ul style="list-style-type: none"> • Vehicle Type: Car, SUV, Van, Bus, Forklift, Excavator, Tow truck, Truck, Fire engine, Ambulance, Police car, Motorbike, Bicycle, E-Bike and Other • Vehicle Color: Black, White, Gray, Red, Yellow, Green and Blue • Plate Color: Black, White, Red, Yellow, Green and Blue

Step5: Set LPR Message Post Settings.

Enable LPR

Country / Region

Image Settings >

Detection Settings >

LPR Message Post Settings v

Enable LPR Message Post

Post Type HTTP TCP RTSP

Camera LPR Port

Schedule Settings >

Save

Table 127. Description of the buttons

Parameters	Function Introduction
Enable LPR Message Post	Check the checkbox to enable LPR Message Post. It will push information to some third-party devices or software that are compatible with ours.
Post Type	Information can be pushed by RTSP , TCP or HTTP .
HTTP Method	There are two HTTP push methods, including Post and Get.
Snapshot Type	Three kinds of snapshot can be chosen: All, License Plate and Full Snapshot. When you choose All, License Plate Snapshot and Full Snapshot will be pushed. Note: This option is available just for Post HTTP Method.
HTTP Notification URL	LPR camera can use the API URL to send LPR information to back-end devices when the license plate is recognized. API URL format fills as below: http://IP:Port/api/lpr?
User Name	Receiver name
Password	Receiver Password

[Schedule Settings]**Step6:** Schedule Settings.

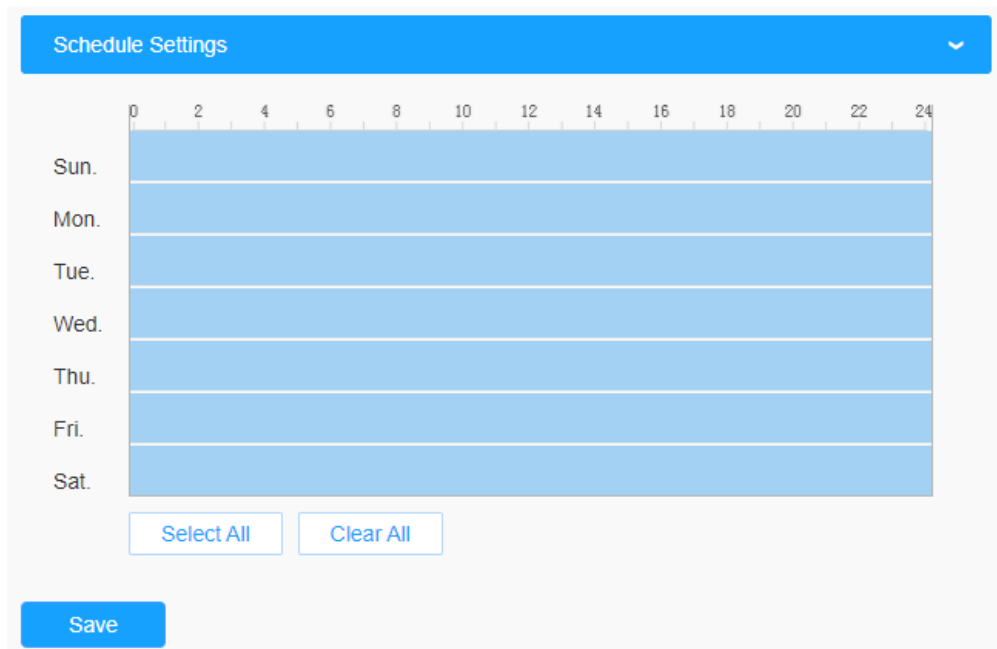
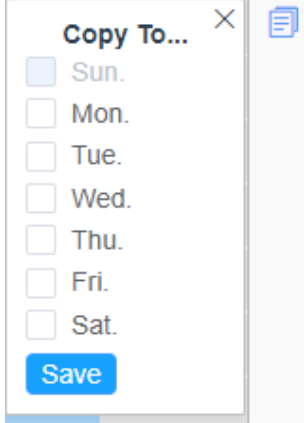

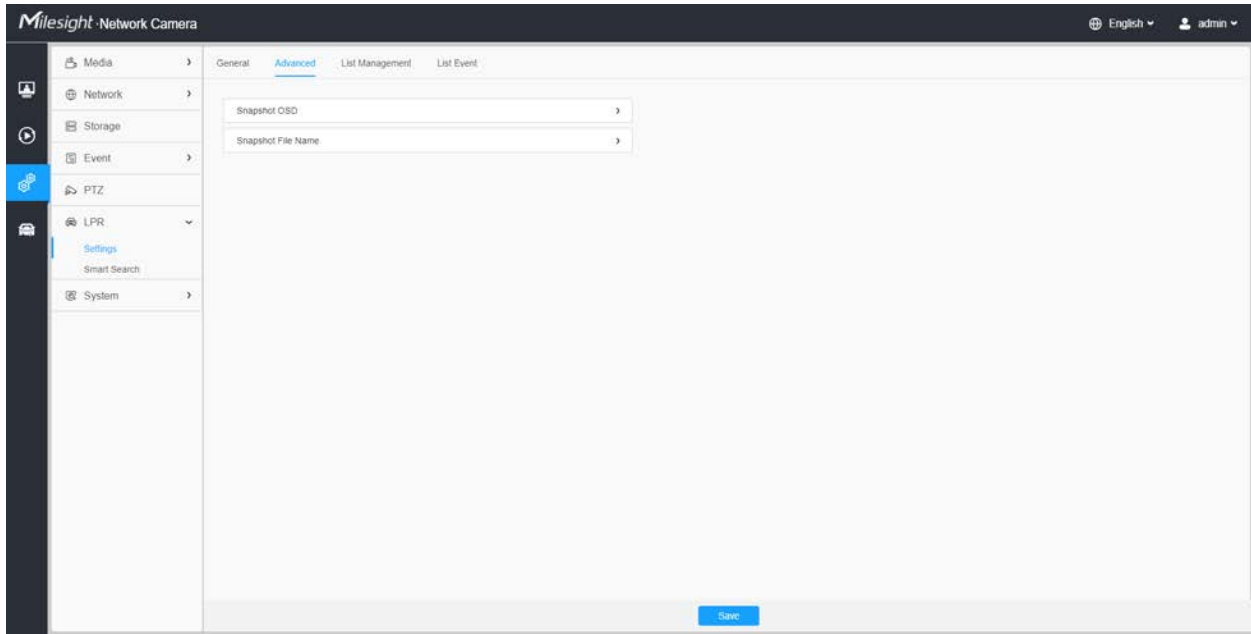

Table 128. Description of the buttons

Parameters	Function Introduction
	<p>Copy the schedule area to another date.</p>
	<p>Select all schedule.</p>
	<p>Clear all schedule.</p>

Advanced

In the interface, you can set display information on snapshot of license plate recognition, and also customize the file name of snapshots which are uploaded via FTP or Email or stored on local LPR Picture File Path.



[Snapshot OSD]

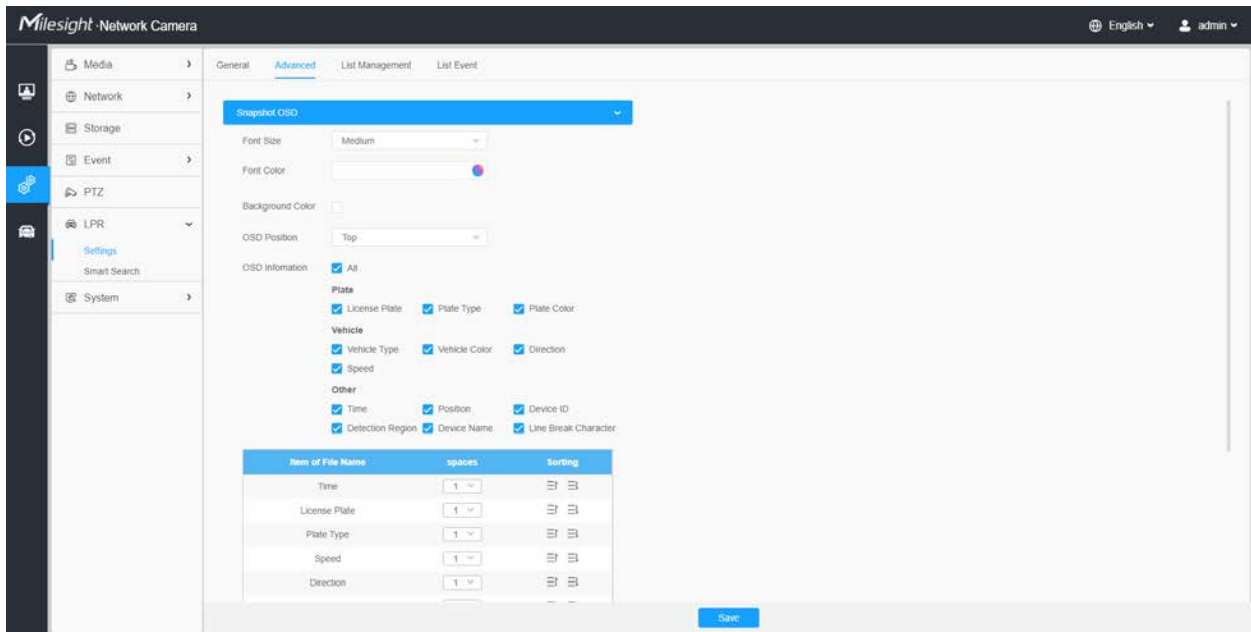





Table 129. Description of the buttons

Parameters	Function Introduction
<p>Font Size</p>	<p>Smallest/Small/Medium/Large/Largest are available for OSD information.</p> <p> Note: Snapshot OSD font size and Image OSD font size are corresponded.</p>
<p>Font Color</p>	<p>Enable to set different colors for OSD information.</p> <p> Note: Snapshot OSD font color and Image OSD font color are corresponded.</p>
<p>Background Color</p>	<p>Check the checkbox to select background color of snapshot OSD information.</p> <p> Note: Background color cannot be the same with font color.</p>
<p>OSD Position</p>	<p>Top/Bottom/Top outside the picture/Bottom outside the picture are available for OSD position.</p>

Parameters	Function Introduction
<p style="text-align: center;">OSD Information</p>	<p>Customize the OSD content. You can set OSD Information as shown below:</p> <div data-bbox="654 428 1354 751" style="border: 1px solid #ccc; padding: 10px; background-color: #f9f9f9;"> <p>OSD Information <input type="checkbox"/> All</p> <p>Plate</p> <p><input type="checkbox"/> License Plate <input type="checkbox"/> Plate Type <input type="checkbox"/> Plate Color</p> <p>Vehicle</p> <p><input type="checkbox"/> Vehicle Type <input type="checkbox"/> Vehicle Color <input type="checkbox"/> Direction</p> <p><input type="checkbox"/> Speed</p> <p>Other</p> <p><input type="checkbox"/> Time <input type="checkbox"/> Position <input type="checkbox"/> Device ID</p> <p><input type="checkbox"/> Detection Region <input type="checkbox"/> Device Name <input type="checkbox"/> Line Break Character</p> </div> <p>When license plate is recognized and the alarm is triggered, the snapshot of license plate recognition will show as below:</p> <div data-bbox="654 865 1354 1247" style="border: 1px solid #ccc; padding: 5px;">  </div>

[Snapshot File Name]

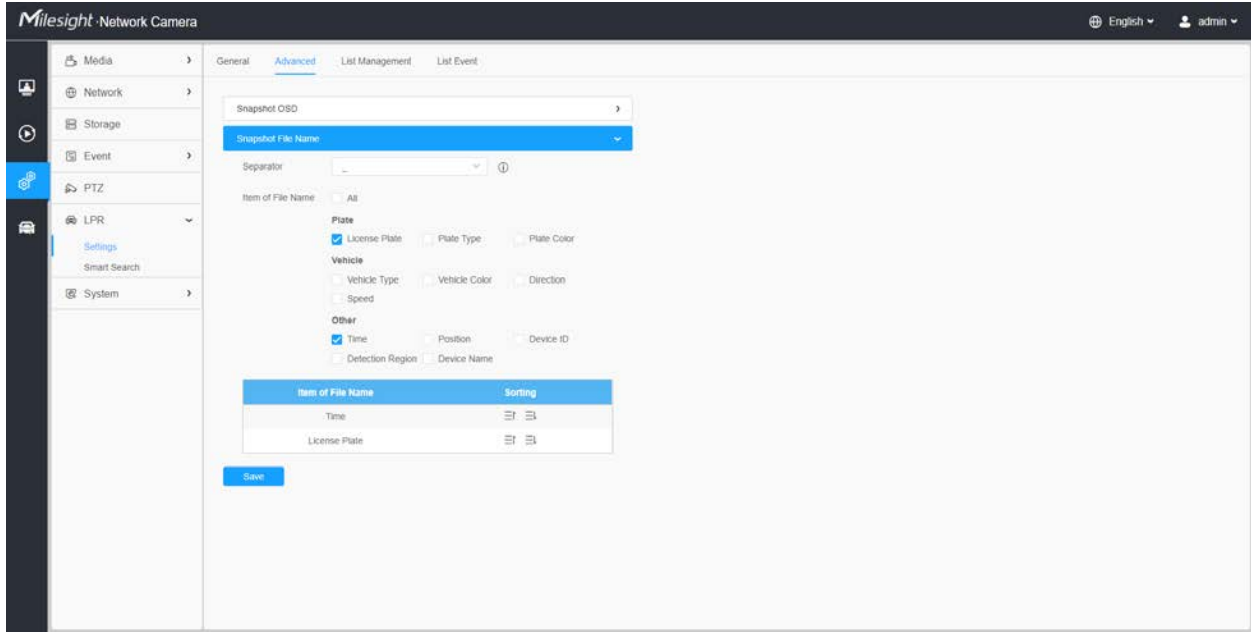



Table 130. Description of the buttons

Parameters	Function Introduction
<p>Separator</p>	<p>“-”, “_” and Space are available for File Name Separator format. The default separator is “-”.</p>
<p>Item of File Name</p>	<p>You can customize the snapshot file name according to items chosen.</p> <div style="border: 1px solid #ccc; padding: 10px; background-color: #f9f9f9;"> <p>Item of File Name <input type="checkbox"/> All</p> <p>Plate</p> <p><input checked="" type="checkbox"/> License Plate <input type="checkbox"/> Plate Type <input type="checkbox"/> Plate Color</p> <p>Vehicle</p> <p><input type="checkbox"/> Vehicle Type <input type="checkbox"/> Vehicle Color <input type="checkbox"/> Direction</p> <p><input type="checkbox"/> Speed</p> <p>Other</p> <p><input checked="" type="checkbox"/> Time <input type="checkbox"/> Position <input type="checkbox"/> Device ID</p> <p><input type="checkbox"/> Detection Region <input type="checkbox"/> Device Name</p> </div>

Each time when an item is checked, the list will add the item row, including the item name and sorting operation. You can click  and  button to sort these items, and choose separator to connect these items name. Also, the content of Position and Device ID items can be customized. When you check all items, the function interface will show as below:

Item of File Name All

Plate

License Plate Plate Type Plate Color

Vehicle

Vehicle Type Vehicle Color Direction

Speed

Other

Time Position Device ID

Detection Region Device Name

Item of File Name	Sorting
Time	⇅ ⇅
License Plate	⇅ ⇅
Plate Type	⇅ ⇅
Speed	⇅ ⇅
Direction	⇅ ⇅
Detection Region	⇅ ⇅
Position: <input type="text" value="Position"/>	⇅ ⇅
Device Name	⇅ ⇅
Device ID: <input type="text" value="Device ID"/>	⇅ ⇅
Plate Color	⇅ ⇅
Vehicle Type	⇅ ⇅
Vehicle Color	⇅ ⇅

 **Note:** You need to check at least one item.

For example, you can choose items, separator and items sorting as below:

Item of File Name All

Plate

License Plate Plate Type Plate Color

Vehicle

Vehicle Type Vehicle Color Direction

Speed

Other

Time Position Device ID

Detection Region Device Name

Item of File Name	Sorting
Time	⇅ ⇅
License Plate	⇅ ⇅

Once license plate is recognized, and the snapshot will be uploaded via FTP or Email or stored on your local LPR Picture File Path. Then, You can see the snapshot file name which you customize as shown below:

Full-snapshot Recognized successfully



Full-snapshot Recognized failed



420201116021729_RT528N

License plate snapshot Recognized successfully



20201116021729_RT528N

License plate snapshot Recognized failed



20201116021729_##528N

Note:

- If the item checked is not recognized successfully, then the item will be displayed with the specific symbol “#”.
- The file name of full-snapshot will be preceded by a number of 4.

List Management

Add the license plates to this interface as Black or White type (Black/White List), and then you can set the alarm action for these license plates in the corresponding black list mode or white list mode interface. When these license plates are detected, the camera will respond according to your settings.

When adding the license plates, you can also define the ID card number for the license plate, when the camera identifies these license plates and recognizes the attached ID card number, it will send the ID card number to your parking system through the **Wiegand protocol**, and then your system can respond based on the received information, such as access control.

 **Note:** Please make sure you have correctly connected the Wiegand interface to the camera and enabled it, for more information please refer to: [Wiegand \(page 287\)](#).

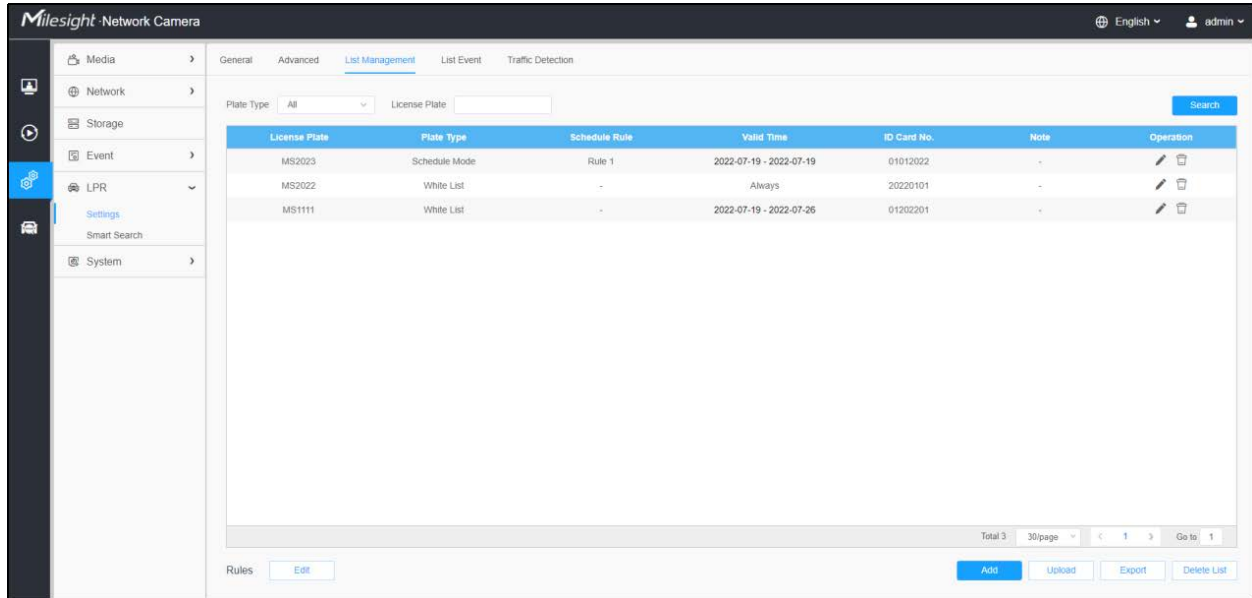











License Plate	Plate Type	Schedule Rule	Valid Time	ID Card No.	Note	Operation
MS2023	Schedule Mode	Rule 1	2022-07-19 - 2022-07-19	01012022	-	 
MS2022	White List	-	Always	20220101	-	 
MS1111	White List	-	2022-07-19 - 2022-07-26	01202201	-	 

Table 131. Description of the buttons

Parameters	Function Introduction
<p>Add License Plate</p>	<p>Select the license plate type as black or white, enter the ID Card number and license plate, click the "Add" button, the license plate will be added successfully.</p> 
<p>Batch Upload</p>	<p>You can add a csv form with the license plate you want to add, click the "Browse" button to import the form to this interface, click the "Upload" button, the license plates will be added successfully.</p> <p> Note: You can first download the template as a reference in this interface.</p>
<p>List Search</p>	<p>Select Plate Type or directly enter the license plate number, click the "Search" button, the corresponding license plate will be displayed in the list below.</p>
<p>Export List</p>	<p>Click the "Export List" button to export the license plate in the current list to a csv form locally.</p>
<p>Delete List</p>	<p>Click the "Delete List" button to delete all the license plate in the current list.</p>

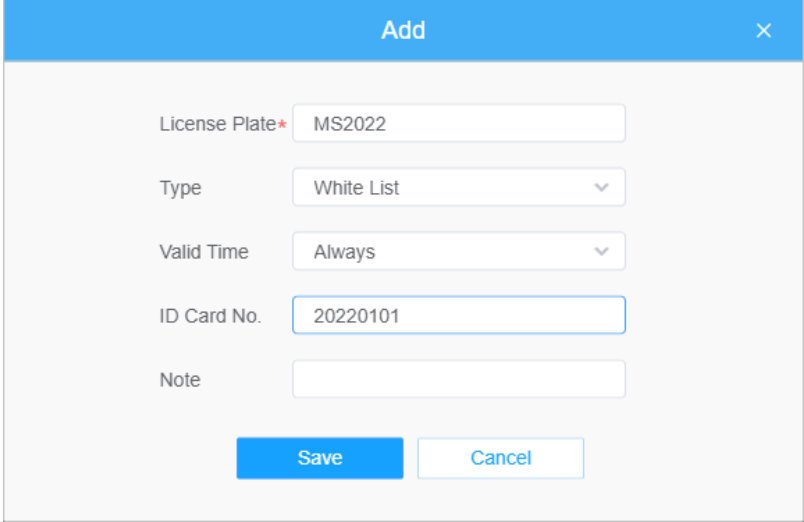
Parameters	Function Introduction
<p style="text-align: center;">Schedule Rules</p>	<p>Click the "Edit" button to customize a rule.</p>  <p>And then set the license plate to Schedule Mode and choose a custom schedule rule that can configure the license plate as Black List or White List at different times.</p>  <p> Note: Support setting up to 4 Schedule Rules for Schedule Mode.</p>

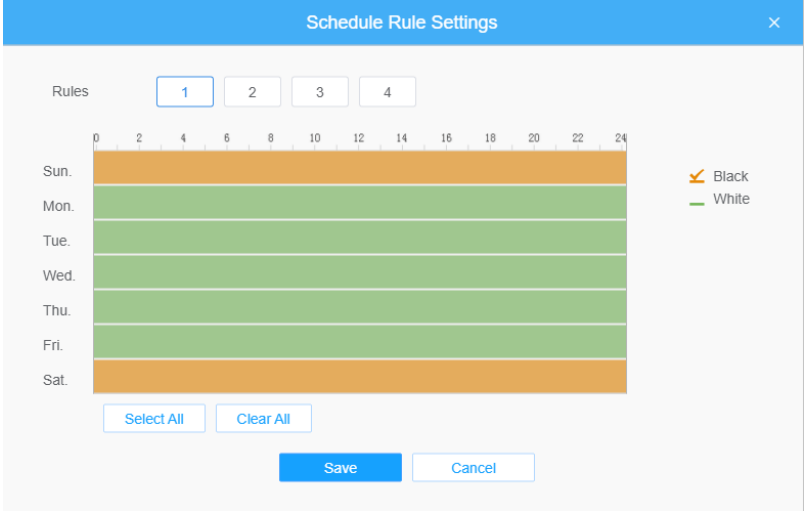
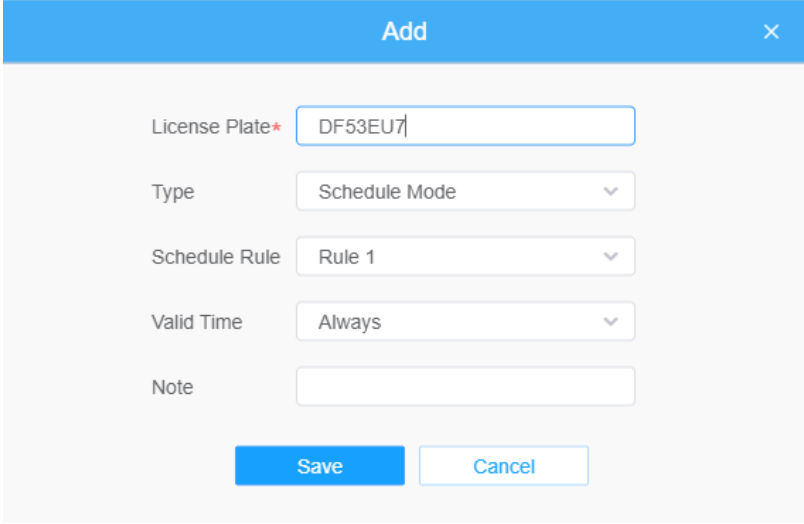
 **Note:** It supports adding 1000 Black List and White List.

List Event

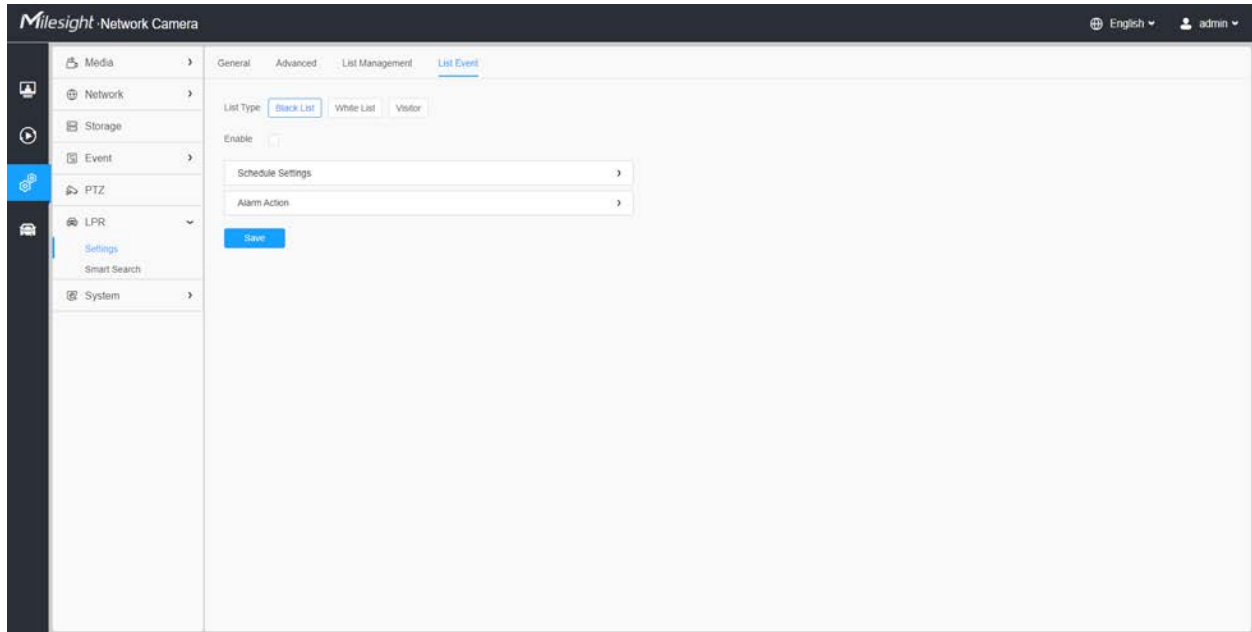

Step1: Select the List Type. Check the check box to enable Black List/White List/Visitor mode.

Step2: The corresponding alarm icon is triggered when the Black List/White List/Visitor vehicles passing by.

Black List:

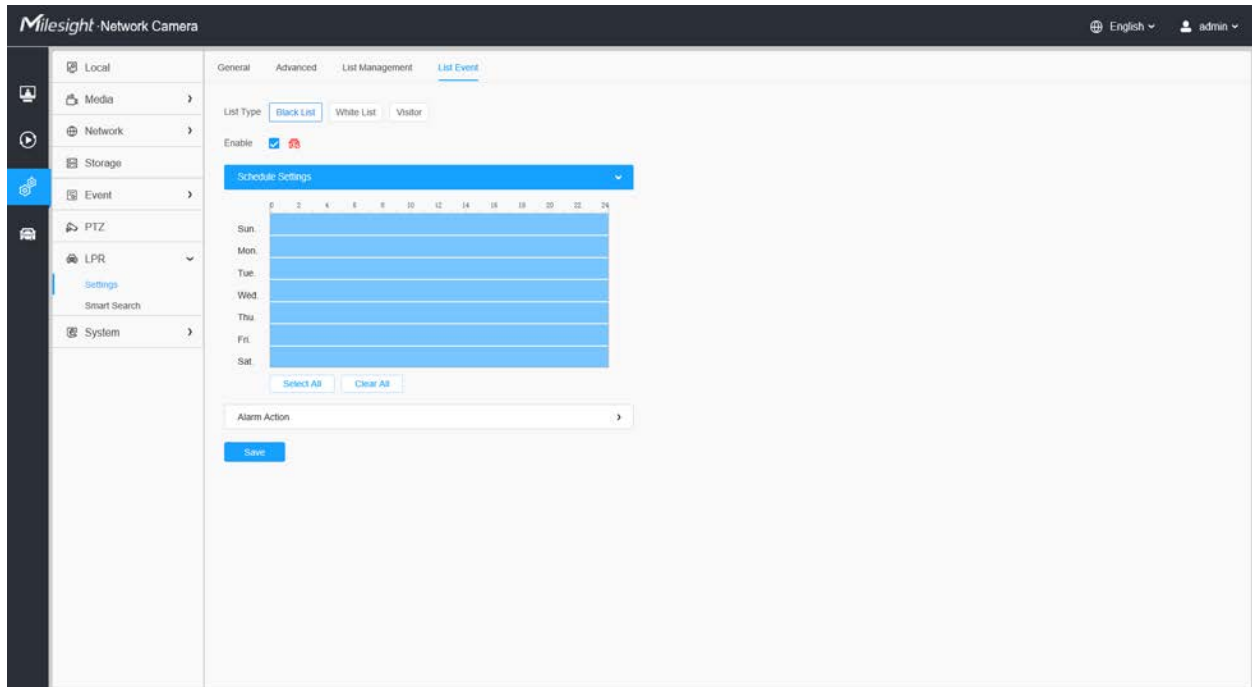

The screenshot shows the Milesight Network Camera interface. At the top, there are settings for 'Primary Stream', 'HTTP', 'Balanced', and 'LPR'. The main video feed shows a road with a white van on the left and a black car on the right. A red arrow points to a notification icon in the top right corner. Below the video feed, a 'Recognition Result' box shows details for license plate DOK69: Plate Type: Black List, Plate Color: White, Vehicle Color: Black, Vehicle Type: Car, Direction: Away. Below this is a table of recognition results.

No.	License Plate	Snapshot	Plate Type	Plate Color	Vehicle Type	Vehicle Color	Speed	Direction	Detection Region	Time	Operation
14	DOK69		Black List	White	Car	Black	-	Away	1	2022-04-21 23:25:42	
13	BOJY11		Visitor	White	Car	Black	-	Away	1	2022-04-21 23:25:39	
12	ZBKZ2		Visitor	White	Car	Red	-	Away	2	2022-04-21 23:25:23	
11	MGB82		Visitor	White	Bus	Blue	-	Away	2	2022-04-21 23:25:21	
10	DOCG1		Visitor	White	Car	White	-	Away	2	2022-04-21 23:25:19	
9	FEJ01		Visitor	White	Car	Black	-	Away	3	2022-04-21 23:25:17	
8	DOJ02		Visitor	White	Car	Gray	-	Away	2	2022-04-21 23:25:14	
7	WHV02		Visitor	White	Car	Gray	-	Away	2	2022-04-21 23:25:10	
6	PHW41		White List	White	Minibus	Red	-	Away	0	2022-04-21 21:35:04	

White List:

The screenshot shows the Milesight Network Camera interface with the 'List Event' configuration page. The 'List Type' is set to 'White List'. The 'Enable' checkbox is checked. The 'Schedule Settings' section shows a calendar grid for days of the week (Sun, Mon, Tue, Wed, Thu, Fri, Sat) and hours of the day (0, 2, 4, 6, 8, 10, 12, 14, 16, 18, 20, 22, 24). The 'Alarm Action' dropdown is set to 'None'. There are 'Select All' and 'Clear All' buttons for the schedule settings.

Recognition Result

Plate Type: **White List** | Plate Color: White | Vehicle Type: Minibus | Direction: Away

No.	License Plate	Snapshot	Plate Type	Plate Color	Vehicle Type	Vehicle Color	Speed	Direction	Detection Region	Time	Operation
15	DOH1		White List	White	Minibus	Red	-	Away	2	2022-04-21 23:25:45	
14	DKK8		Black List	White	Car	Black	-	Away	1	2022-04-21 23:25:42	
13	BOV1		Visitor	White	Car	Black	-	Away	1	2022-04-21 23:25:39	
12	ZBKZ		Visitor	White	Car	Red	-	Away	2	2022-04-21 23:25:23	
11	MGBB		Visitor	White	Bus	Blue	-	Away	2	2022-04-21 23:25:21	
10	DOCG		Visitor	White	Car	White	-	Away	3	2022-04-21 23:25:19	
9	FEXQ		Visitor	White	Car	Black	-	Away	2	2022-04-21 23:25:17	
8	DOJC		Visitor	White	Car	Gray	-	Away	2	2022-04-21 23:25:14	
7	WALURP		Visitor	White	Car	Gray	-	Away	9	2022-04-21 21:25:10	

Visitor:

Local | Media | Network | Storage | Event | PTZ | LPR | Settings | Smart Search | System

General | Advanced | List Management | List Event

List Type: Black List | White List | **Visitor**

Enable:

Schedule Settings

	0	2	4	6	8	10	12	14	16	18	20	22	24
Sun.													
Mon.													
Tue.													
Wed.													
Thu.													
Fri.													
Sat.													

Alarm Action:

Buttons: Select All, Clear All, Save

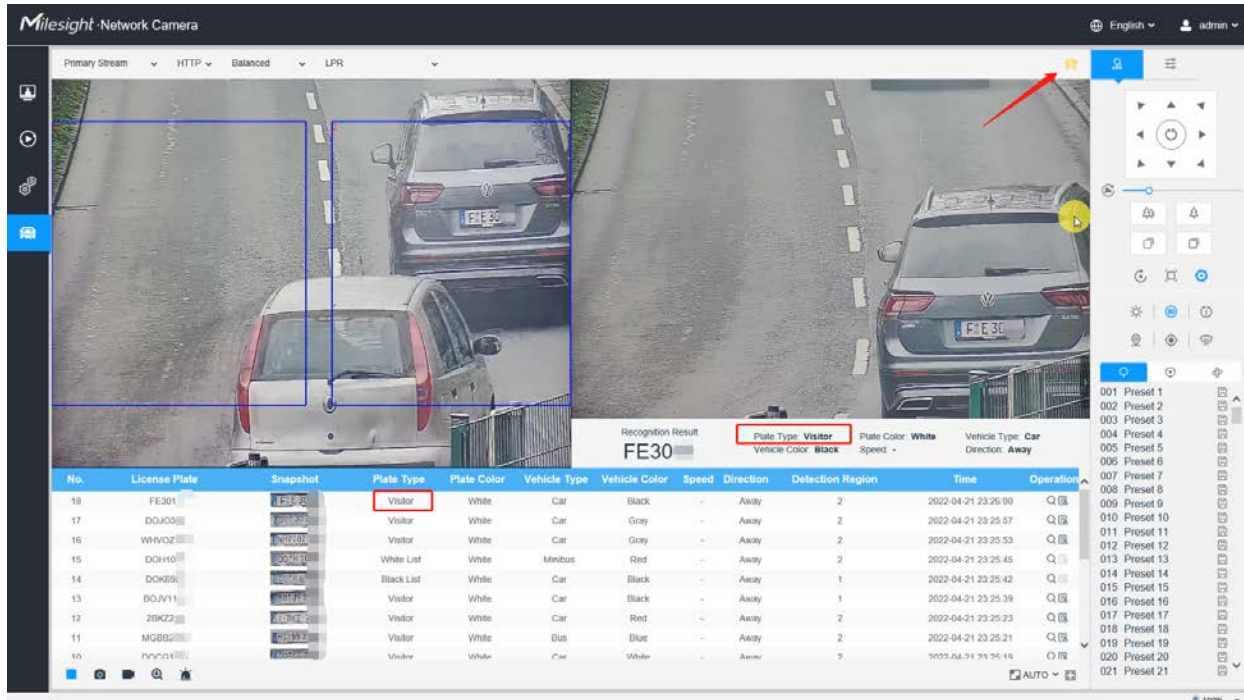

[Schedule Settings]

Step3: Schedule Settings.

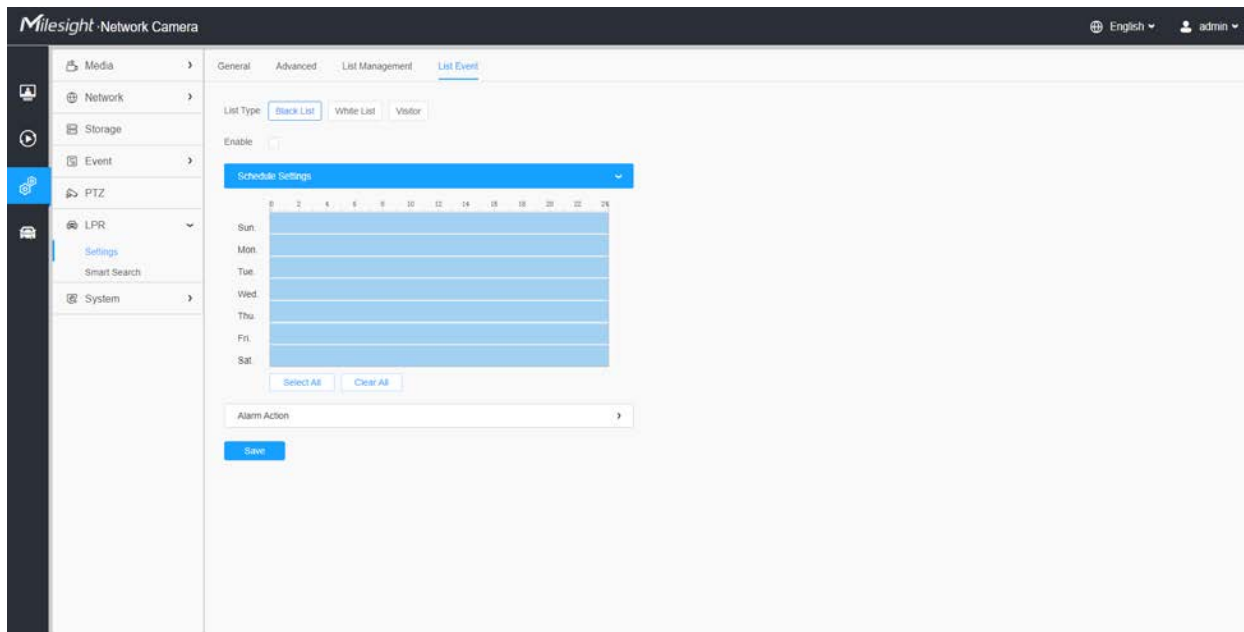
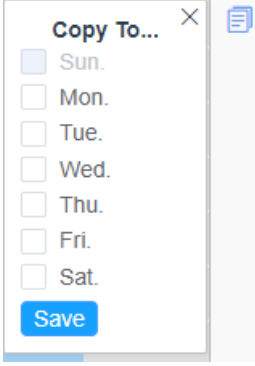
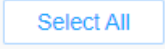



Table 132. Description of the buttons

Parameters	Function Introduction
	<p>Copy the schedule area to another date.</p>
	<p>Select all schedule.</p>
	<p>Clear all schedule.</p>

[Alarm Action]

Step4: Set Alarm Action.

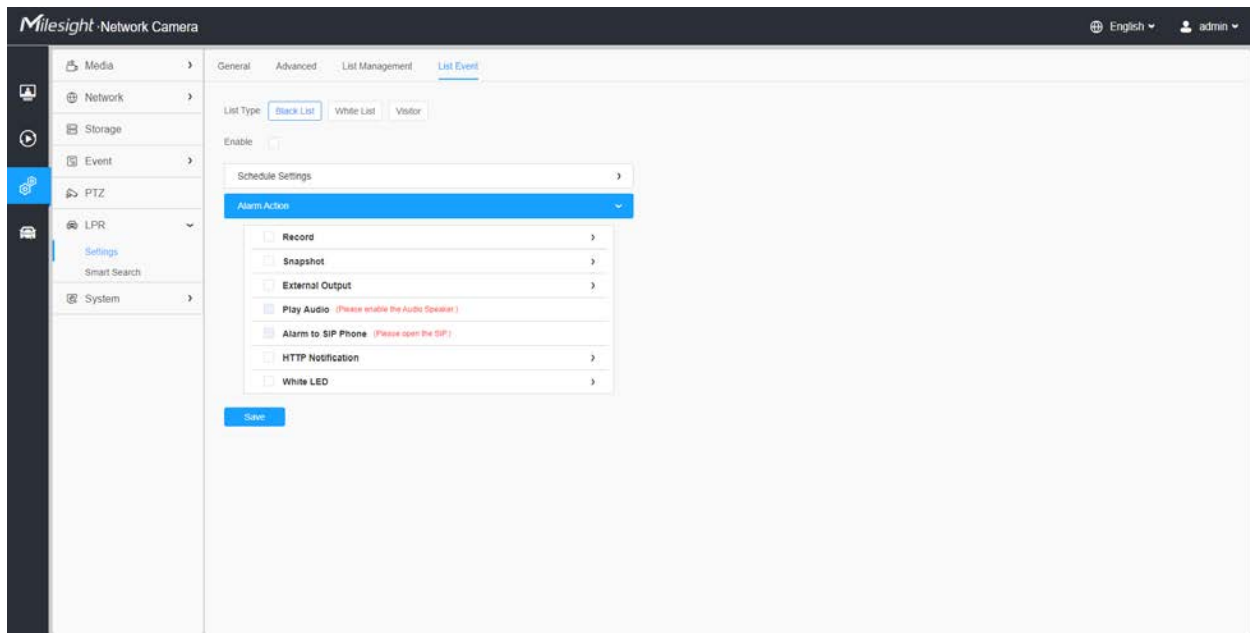

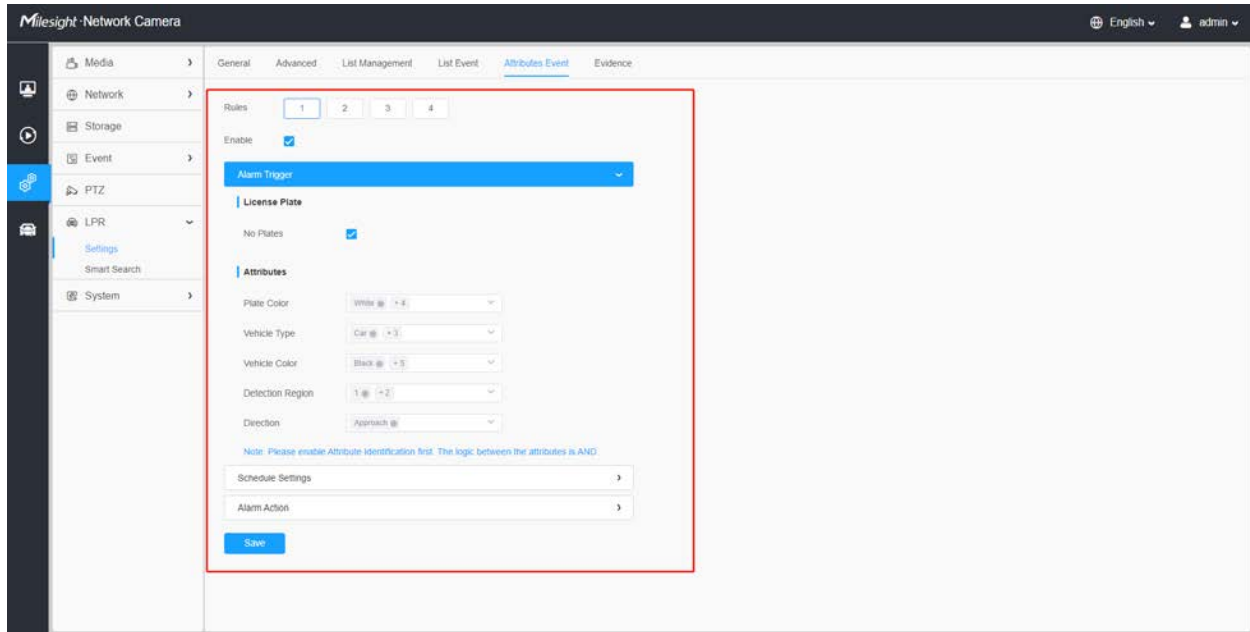

Table 133. Description of the buttons

Parameters	Function Introduction
Record	<p>Duration: Selected the duration time of alarm. 5s/10s/15s/20s/25s/30s are available.</p> <p>Linkage: Save alarm recording files into SD Card or NAS or Upload the recording files via FTP.</p>
Snapshot	<p>Number: The number of snapshot, 1~5 are available.</p> <p>Interval: This cannot be edited unless you choose more than 1 to Snapshot.</p> <p>Linkage: Save alarm recording files into SD Card or NAS, Upload the recording files via FTP and send alarm email.</p>
External Output	If the camera equips with External Output, you can enable the action after configuring the trigger duration.
Play Audio	<p>Auto/10 seconds/30 seconds/1 minute/5 minutes/10 minutes are available.</p> <p> Note: Please enable the Audio Speaker.</p>
Alarm to SIP Phone	Support to call the SIP phone after enable the SIP function.
HTTP Notification	<p>Support to pop up the alarm news to specified HTTP URL.</p> <p> Note:</p> <ul style="list-style-type: none"> • Three HTTP notifications at most can be added to the same event. • HTTP Notification supports Basic & Digest authentication
White LED	When the alarm triggered, White LED will turn on to warning the detected objects (Only for PTZ Bullet).

Attributes Event

This function can trigger alarms by corresponding attributes of the vehicle and plate or by No-plate Vehicle, which can be of great help in urban management, such as detecting whether there is a vehicle illegally occupying the bus lane, or detecting whether there is a truck entering the city road during the day, etc., to meet a variety of uses.



Settings steps are shown as follows:

Step1: Select an event rule and enable it.

Note: Up to 4 attribute event rules can be set.

Step2: Set the Alarm Trigger as No-plate detection or other attributes.

Note:

- Please enable Attribute Identification first.
- The logic between No plates and Attributes is OR. For example, if I check both No Plates and Attributes, whether "No plates" or other attributes are recognized, the alarm event will be triggered.
- The logic between the attributes is AND. For example, if I check multiple vehicle attributes, the alarm action will only be triggered when the vehicle meets these attributes at the same time.

Step3: Set the schedule.

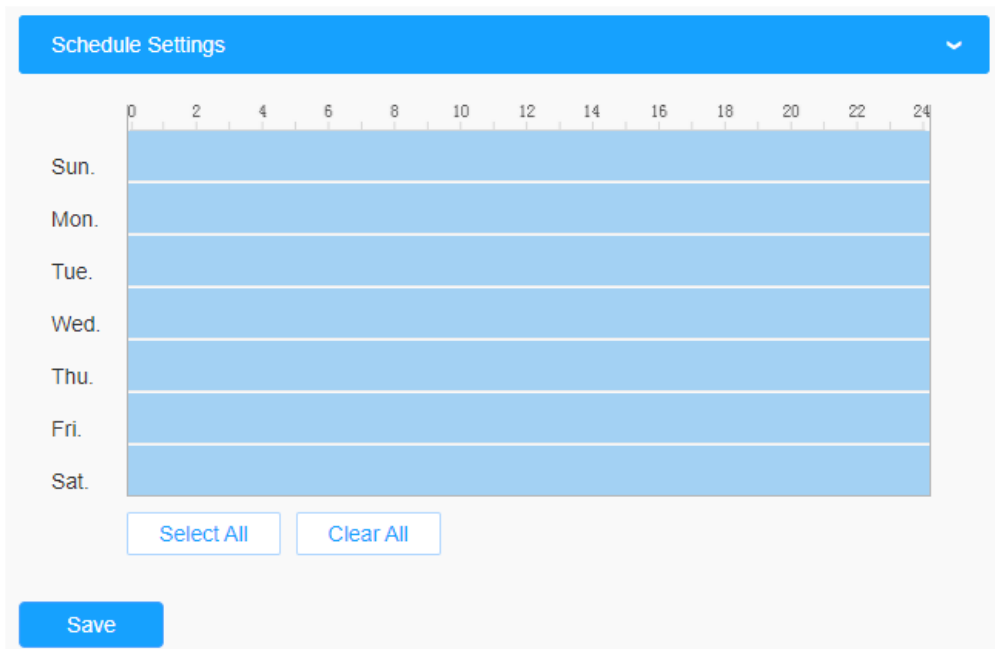
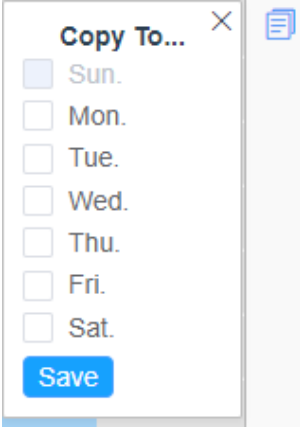



Table 134.

Parameters	Function Introduction
	<p>Copy the schedule area to another date.</p>
	<p>Select all schedule.</p>
	<p>Clear all schedule.</p>

Step4: Set the alarm actions.

Alarm Action
▼

<input type="checkbox"/> Record	>
<input type="checkbox"/> Snapshot	>
<input type="checkbox"/> External Output	>
<input type="checkbox"/> Play Audio (Please enable the Audio Speaker.)	
<input type="checkbox"/> Alarm to SIP Phone (Please open the SIP.)	
<input type="checkbox"/> HTTP Notification	>
<input type="checkbox"/> White LED	>

Save

Table 135.

Parameters	Function Introduction
Record	<p>Duration: Selected the duration time of alarm. 5s/10s/15s/20s/25s/30s are available.</p> <p>Linkage: Save alarm recording files into SD Card or NAS or Upload the recording files via FTP.</p>
Snapshot	<p>Number: The number of snapshot, 1~5 are available.</p> <p>Interval: This cannot be edited unless you choose more than 1 to Snapshot.</p> <p>Linkage: Save alarm recording files into SD Card or NAS, upload the recording files via FTP and send alarm email.</p>
External Output	If the camera equips with External Output, you can enable the action after configuring the trigger duration.
Play Audio	<p>Auto/10 seconds/30 seconds/1 minute/5 minutes/10 minutes are available.</p> <p> Note: Please enable the Audio Speaker.</p>
Alarm to SIP Phone	Support to call the SIP phone after enable the SIP function.
HTTP Notification	<p>Support to pop up the alarm news to specified HTTP URL.</p> <p> Note:</p> <ul style="list-style-type: none"> Three HTTP notifications at most can be added to the same event. HTTP Notification supports Basic & Digest authentication
White LED	When the alarm triggered, White LED will turn on to warning the detected objects (Only for PTZ Bullet).

Evidence

This function can bind other cameras as evidence cameras to assist in capturing the entire monitoring scene of the LPR camera to facilitate forensics and help law enforcement.

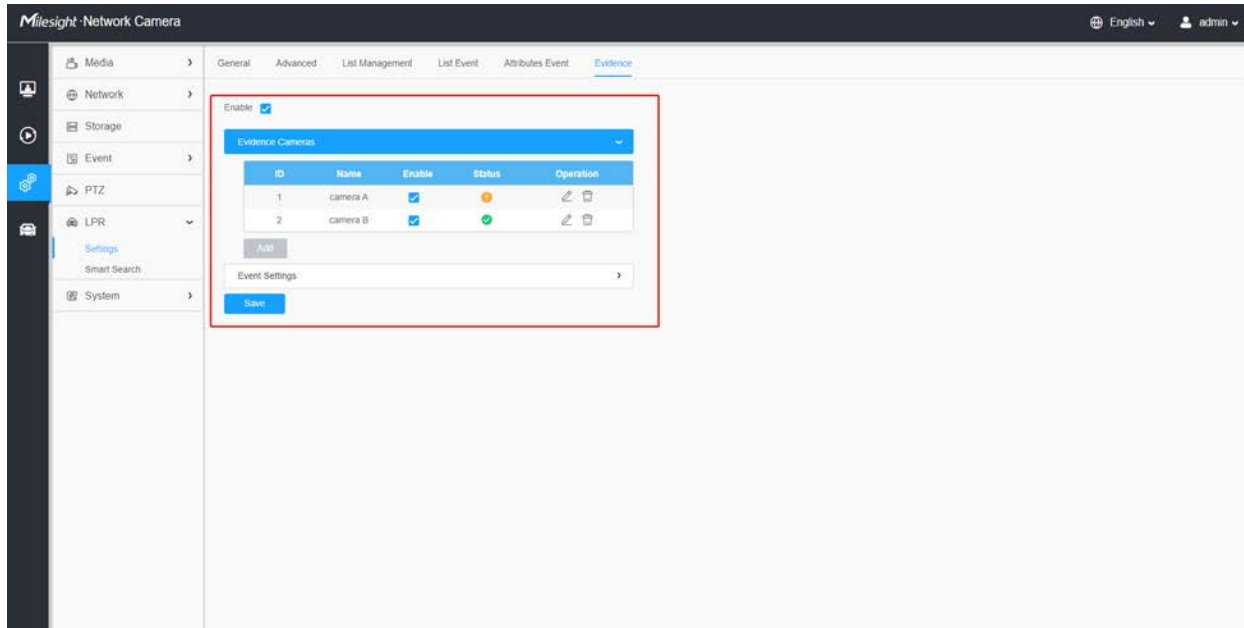

Settings steps are shown as follows:

Step1: Check the checkbox to enable this function.

Step2: Click button to add the evidence camera by entering the user name, password, and Address. And the camera name of the evidence camera can be customized.





Note:



- Up to 2 evidence cameras can be added.
- Evidence camera captures primary stream picture by default.
- For the Address, input evidence camera IP directly for Mlesight camera, and snapshot URL is supported for third-party camera.

Step3: The added evidence cameras will be listed in the interface, and users can edit these cameras separately.

For the meaning of the buttons on the interface, please refer to the following table.

Table 136.

Parameters	Function Introduction
	Enable or disable the evidence camera.
 / 	Check the connection status of the evidence camera.  : Connect  : Disconnect

Parameters	Function Introduction
	Edit the evidence camera.
	Delete the evidence camera.

Step4: Set Capture Conditions. Currently it only supports the always option, which means that as long as the camera recognizes the license plate, the evidence camera will be triggered to capture a picture of the entire scene.

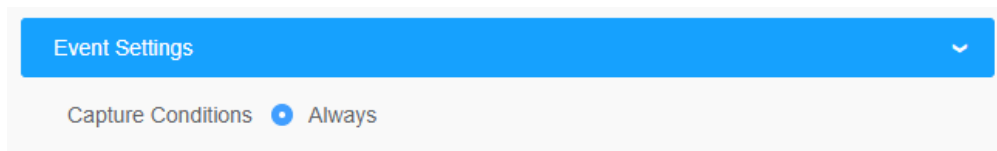

Step5: After completing the above settings, the evidence camera will work together to capture the scene when the LPR camera captures the license plate, which can be viewed on the Live View interface of LPR Mode.

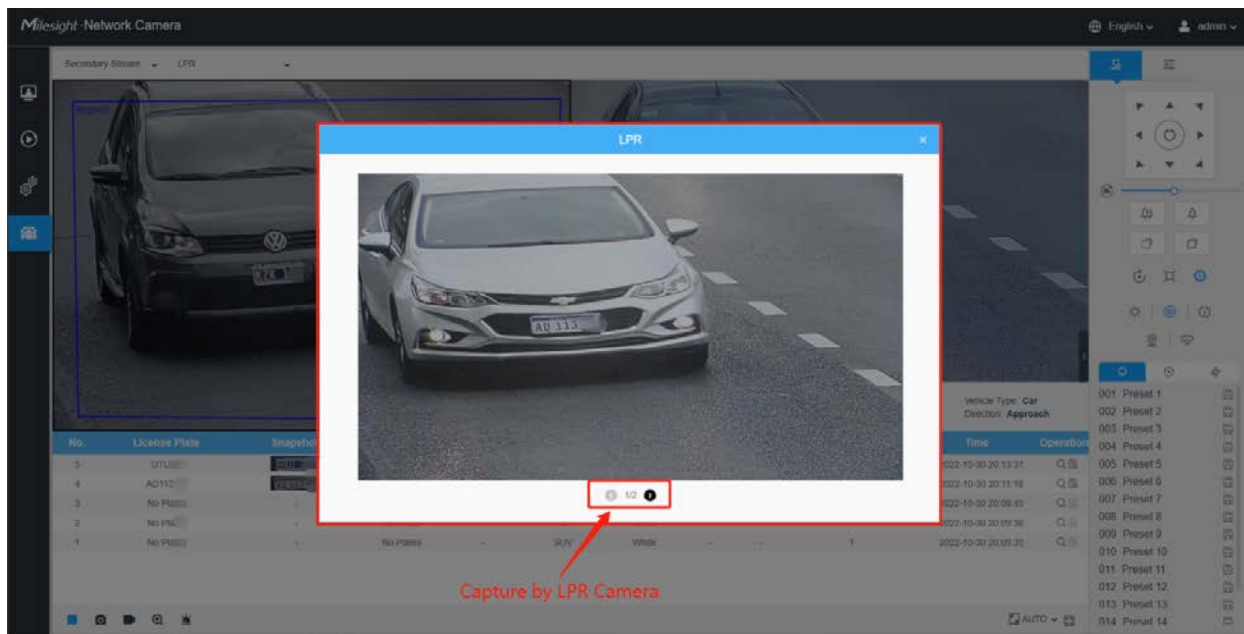

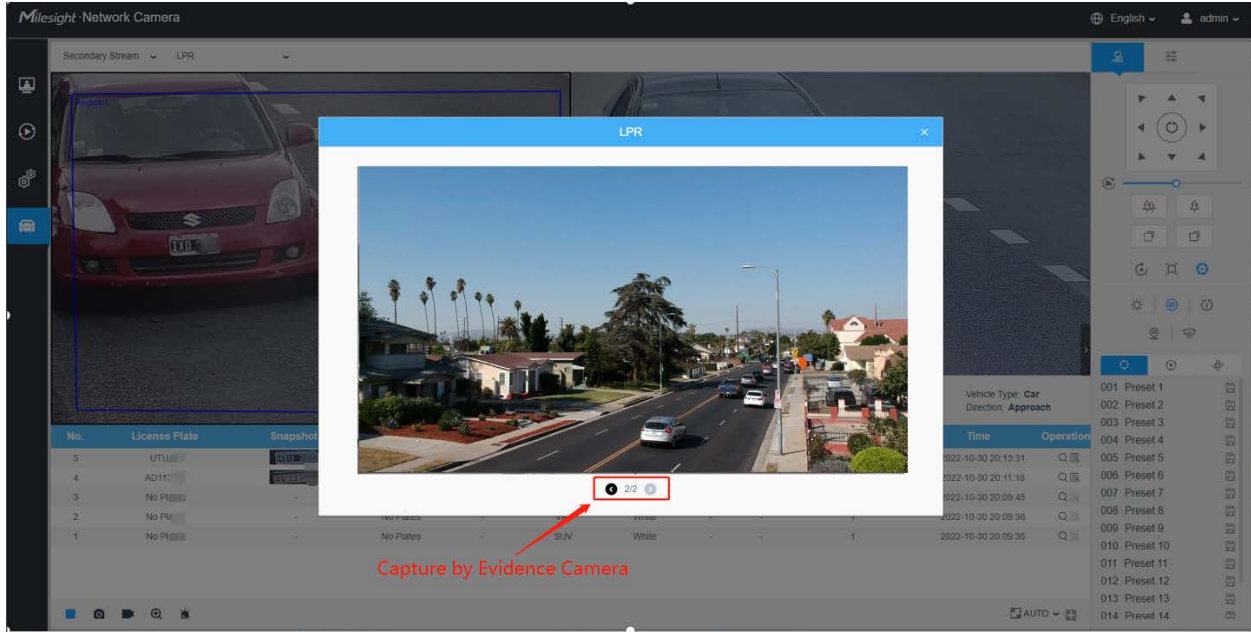

Users can also search and export the image captured by evidence camera in the Smart Search interface.

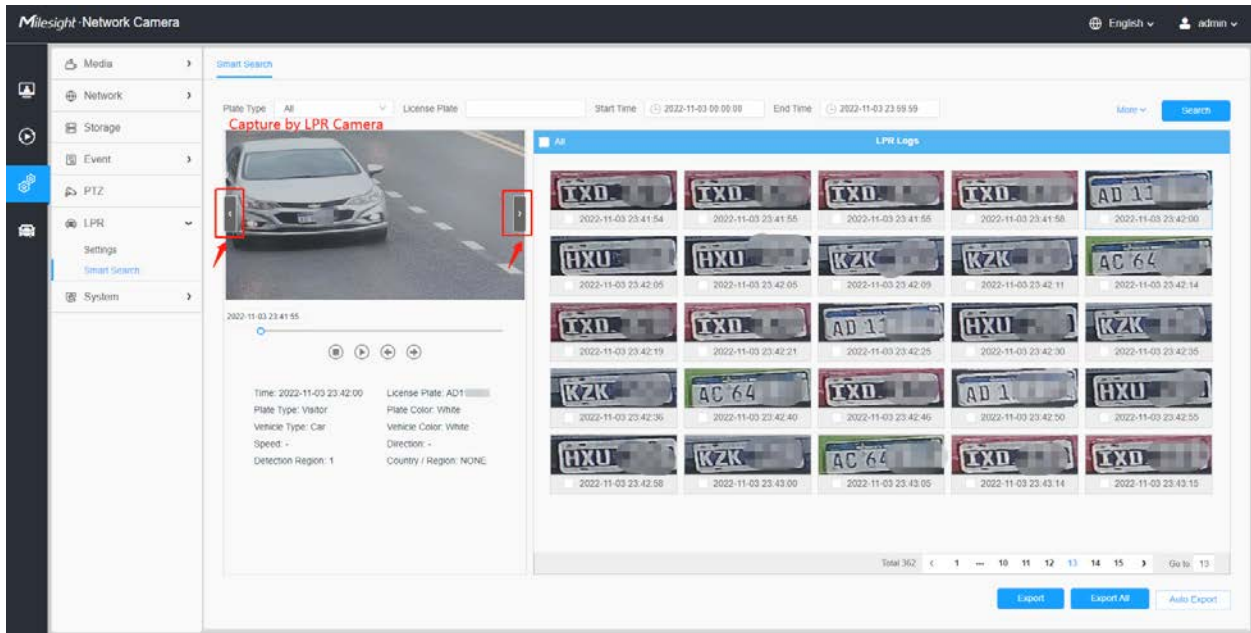

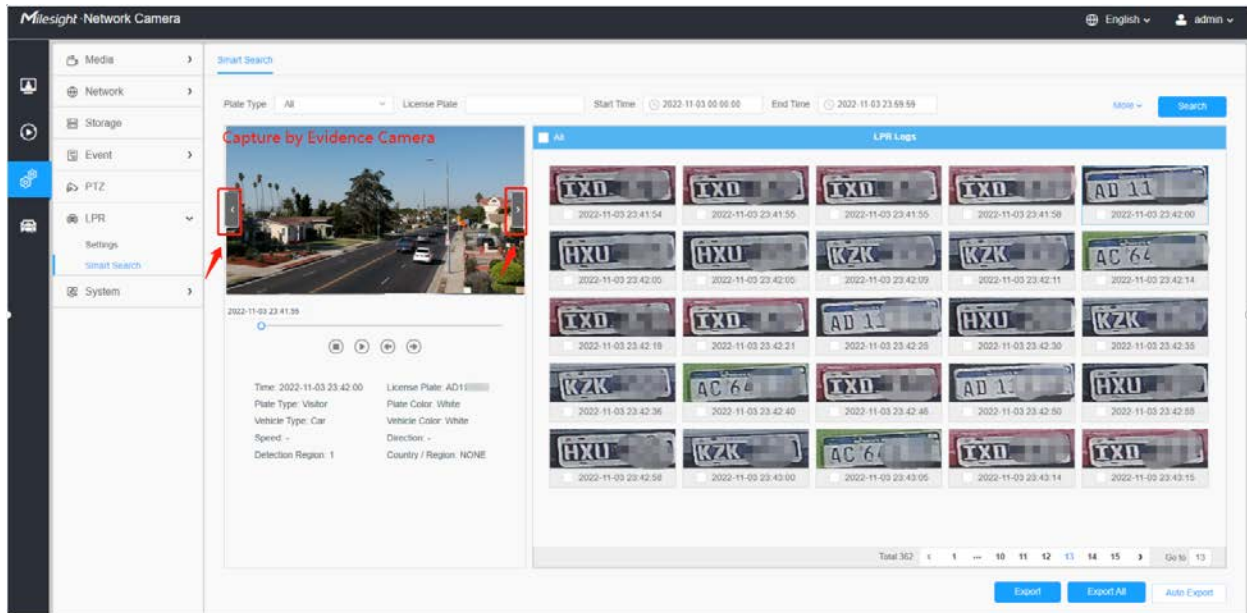

Traffic Detection

The Radar AI LPR Network Camera not only supports the embedded LPR algorithm, but also the deep learning algorithm based on the AI platform, which can achieve higher detection accuracy and richer intelligent functions.

The Radar AI LPR camera is a truly all-in-one integrated camera. The radar module is directly integrated in the camera, making installation more convenient.

In this page, you can configure the Traffic Detection of Radar model.

Note:

- Make sure your camera model is Misesight Radar AI LPR Cameras.
- For more details, please refer to <https://misesight.freshdesk.com/a/solutions/articles/69000797257>.

Step1: Enable the traffic detection.

Go to the “LPR”--> “Settings”--> “Traffic Detection”, check the checkbox to enable Traffic Detection.

Then adjust the detection sensitivity of the radar module, levels 1~4 are available. The higher the sensitivity, the easier the target is to be detected. Users can adjust the detection sensitivity as needed to avoid some missing or false detection, such as false detection caused by rain hitting the radar board.

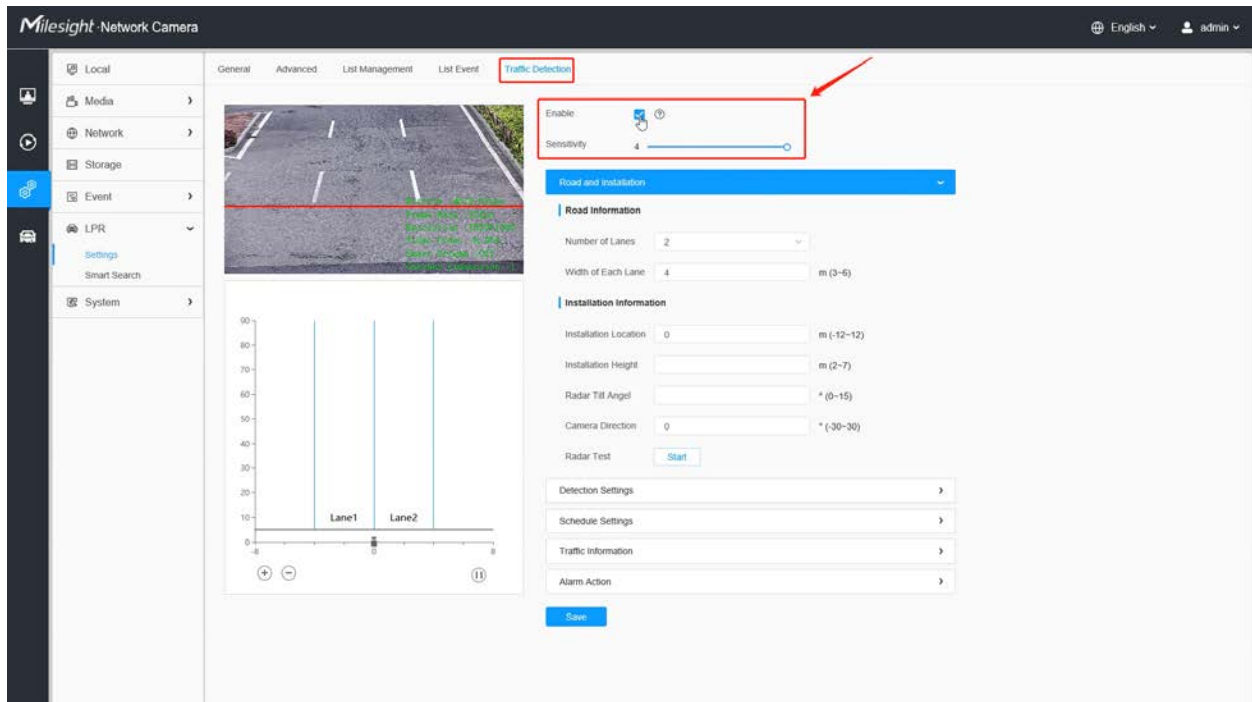

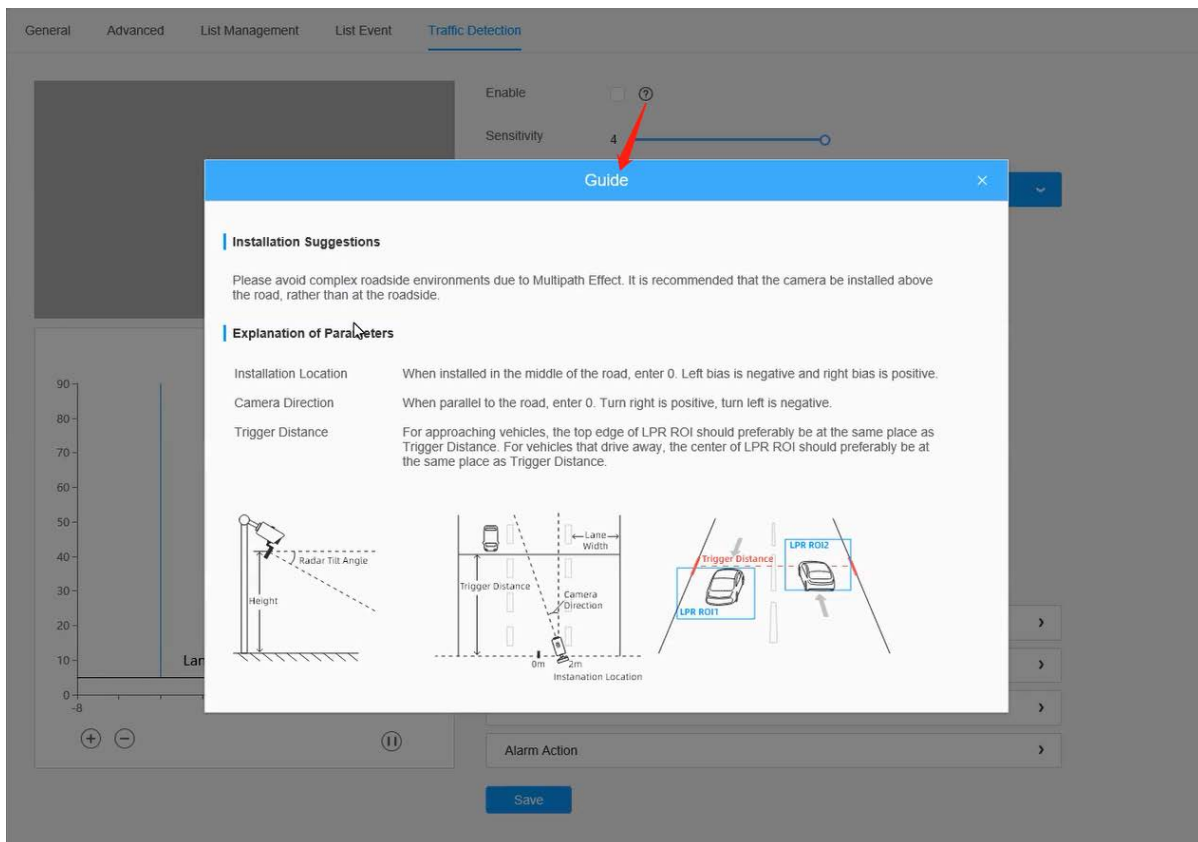

Note: For users who are using the Radar AI LPR Camera for the first time, we recommend clicking the icon on the right to get the quick start guide.

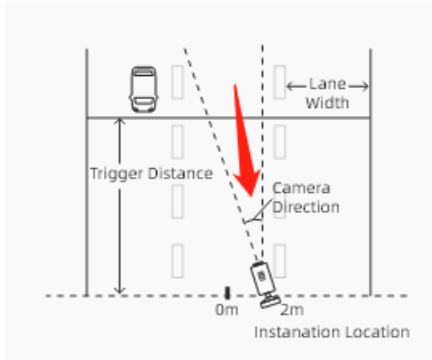

Step2: Fill in the road and installation information as shown below.

Table 137. Description of the buttons

Parameters	Function Introduction
<p>Number of Lanes & Width of Each Lane</p>	<p>Please fill in the number of lanes and the width of each lane according to the actual scene. It supports up to 4 lanes, and the width range of each lane is from 3 to 6 meters.</p>
<p>Installation Location</p>	<p>Please fill in the installation position of the camera on the road, the range is -12 to 12 meters, and the default is 0.</p> <p>If the camera is installed in the middle of the road, fill in 0, otherwise, fill in the corresponding offset distance. It should be noted that the installation position needs to be confirmed as a positive or negative number. With the center of the road as the zero point, if the camera is installed on the left side of the road, it is defined as a negative number, and if it is on the right side, it is defined as a positive number.</p>
<p>Installation Height</p>	<p>Please fill in the installation height according to the actual installation height of the camera, the range is 2 to 7 meters.</p>
<p>Radar Tilt Angle</p>	<p>Please fill in the Radar Tilt Angle according to the actual installation angle between the camera's field of view and the horizontal.</p>
<p>Camera Direction</p>	<p>Please fill in the angle between the direction of the camera installation and the road, the angel range is -30°~30°, and the default is 0°.</p> <p>When the camera is parallel to the road, enter 0. Turn right is positive, turn left is negative as shown below.</p> 

Parameters	Function Introduction
<p style="text-align: center;">Radar Test</p>	<p>After completing the above configuration, you can click the test button, then the above configuration will be automatically saved and the radar module will start to test with the maximum sensitivity and maximum detection range, which is not limited by the lane configuration. In this way, the user can flexibly adjust the configuration according to the position of the target in the coordinates to achieve the most matching configuration.</p> <div style="text-align: center;">  </div> <p> Note: After 30 seconds of testing, the radar test function will be automatically turned off to prevent customers from forgetting to turn off the function.</p>

Step3: Set Detection Settings.

Table 138. Description of the buttons

Parameters	Function Introduction
------------	-----------------------

As shown in the radar configuration page in the figure below, there will be a red line in the preview box of the configuration page. The red line is the position that can be adjusted up and down, and the Trigger Distance is the horizontal distance from the red line to the radar. When the license plate is detected in the LPR detection area, the recognized LPR detection result will match the radar data of the vehicle passing the trigger distance at the same time.

Therefore, please ensure that the position of the red line in the video is the actual horizontal distance from the red line to the radar in the scene, to facilitate better matching between the LPR data and Radar data.

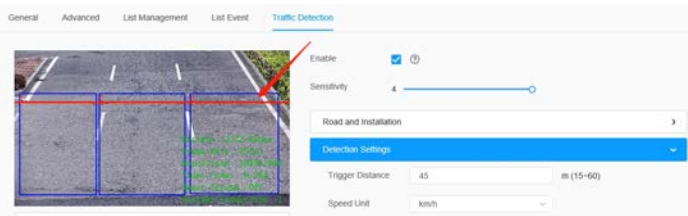

In order to provide more accurate radar detection, for the approaching vehicles, we recommend setting the trigger line at the upper edge of the LPR detection area, and for the leaving away vehicles, we recommend setting the trigger line in the middle of the LPR detection area, as shown below.

For the Oncoming Vehicles:

Trigger Distance

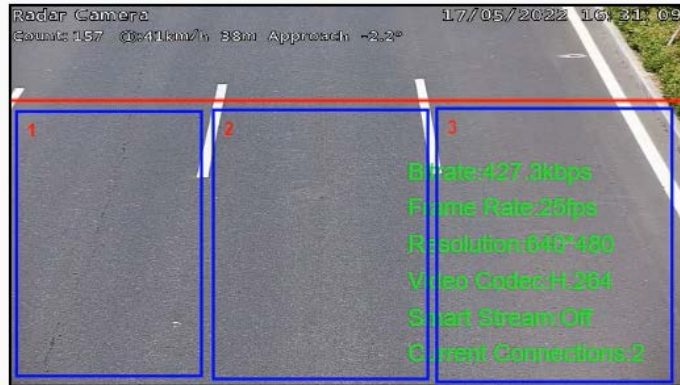

For the Leaving Vehicles:

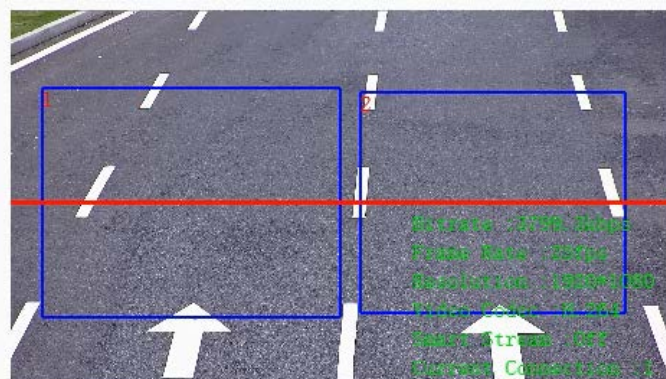

Note: To ensure relative accuracy, users need to fill in the trigger distance after actual measurement, we recommend three ways to get the trigger distance. For more details, please refer to <https://milesight.freshdesk.com/a/solutions/articles/69000797257>.

Parameters	Function Introduction
Speed Unit	Select the speed unit as km/h or mph to meet the needs of customers in different regions.
Match Lanes and LPR Detection Regions	Please match the LPR detection region and lane one by one according to the actual scene.
Radar Message Post Settings	It supports the compatibility of radar data with back-end software via TCP, such as Milesight VMS Enterprise.

After completing the Road&Installation Settings and Detection Settings, these information will be dynamically matched with the coordinate map in the lower left corner, and the detected target will also be dynamically displayed on the coordinate map, which is convenient for users to view the detection results in real time.

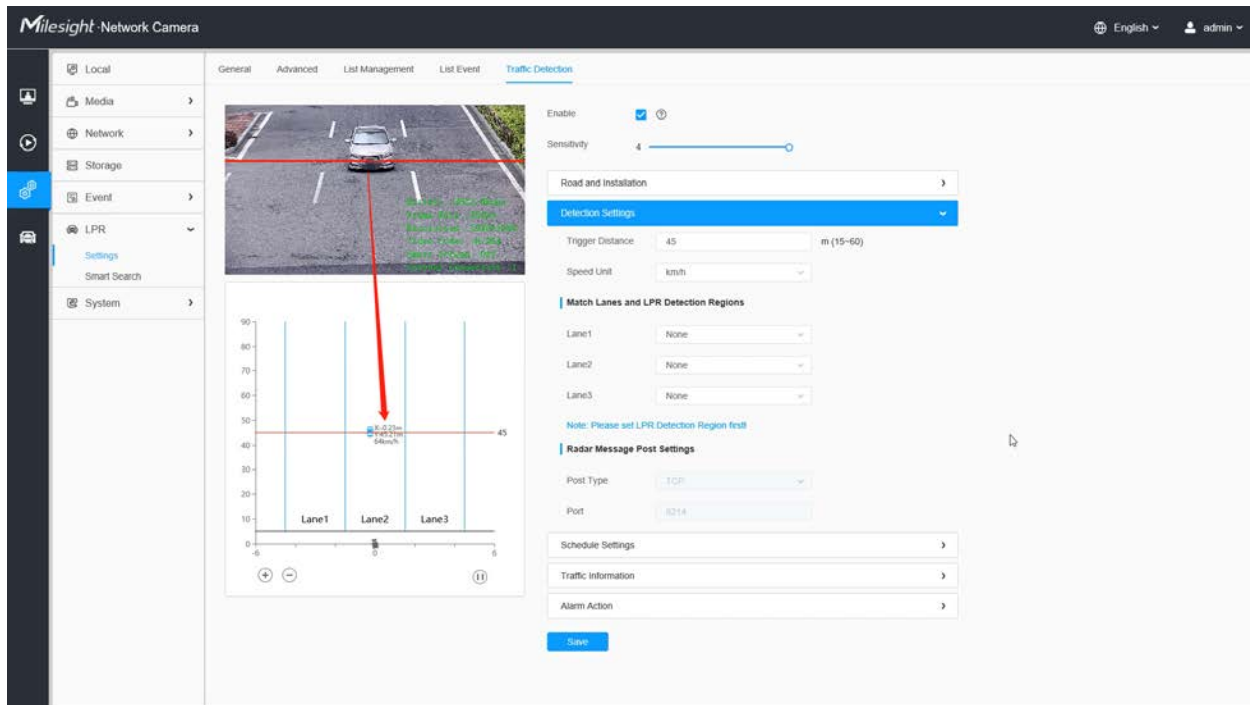

Step4: Schedule Settings.

Set the effective time of traffic detection.

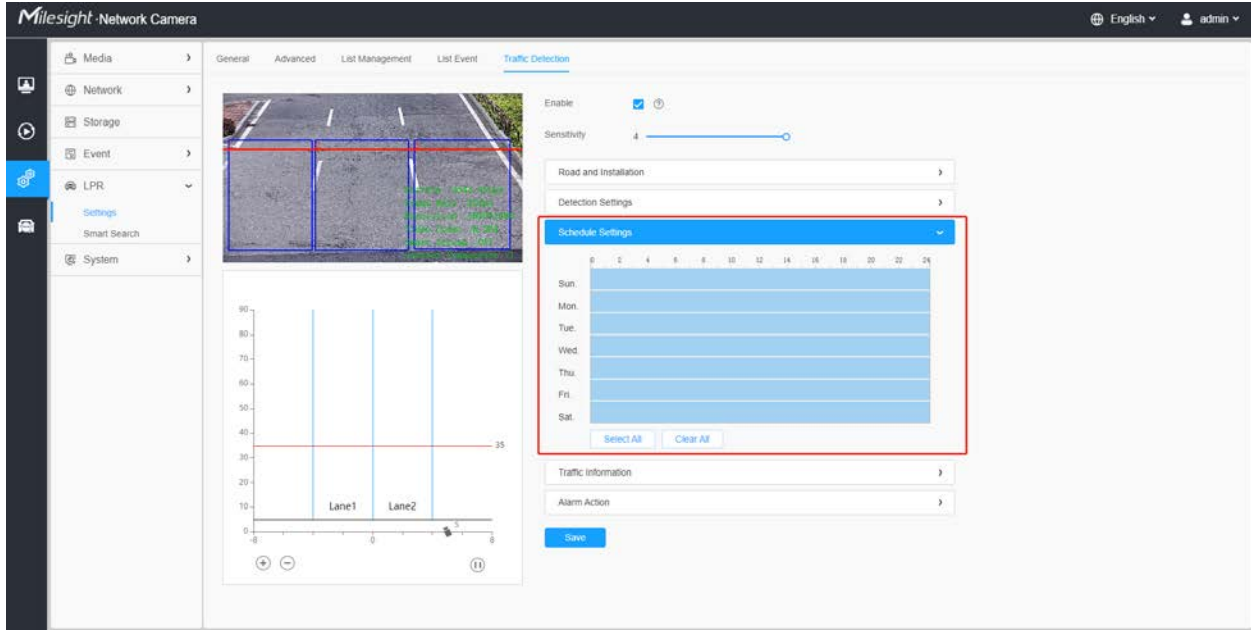

Step5: Traffic OSD Settings.

Customers can choose the information that needs to be displayed in Live Video and the display format, such as color, size, etc.

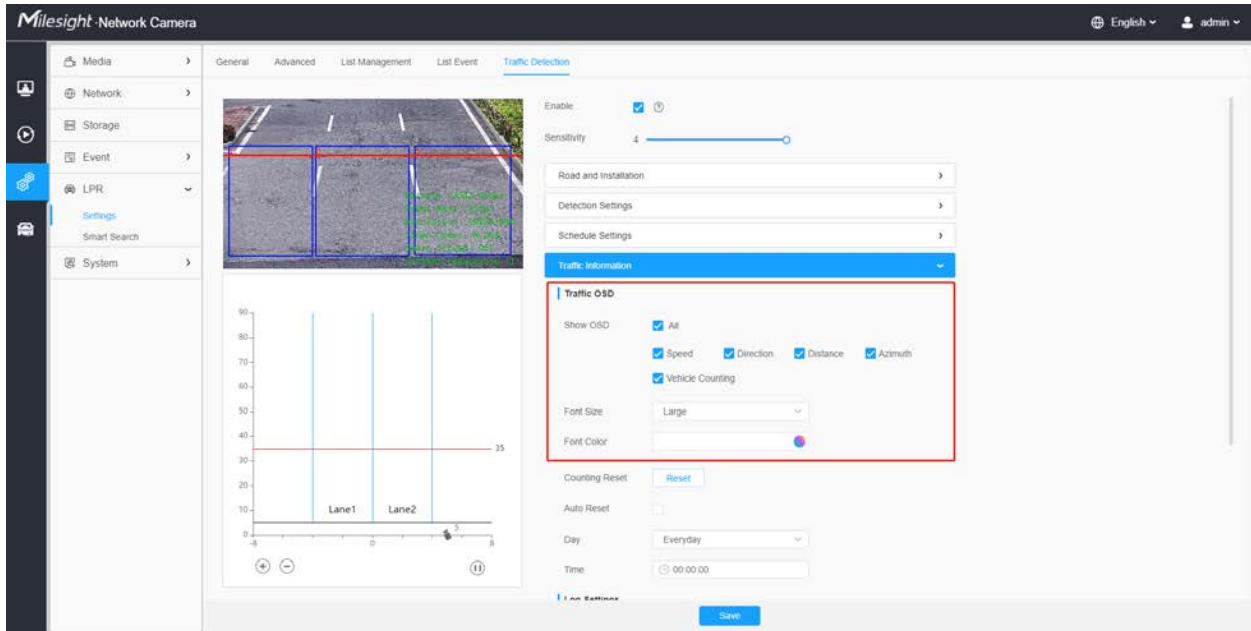
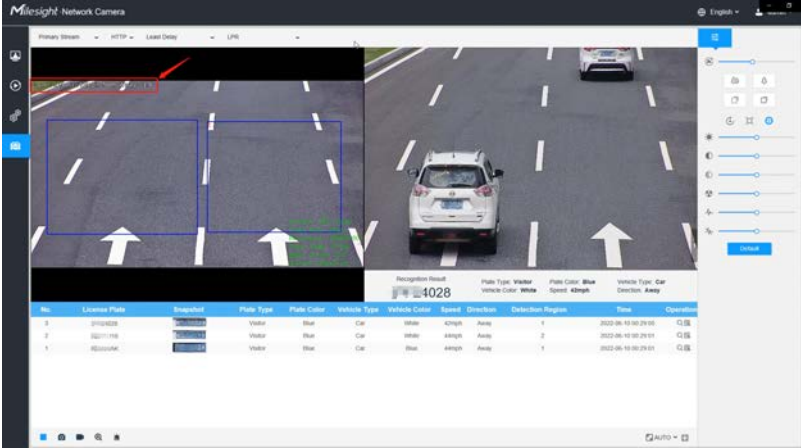
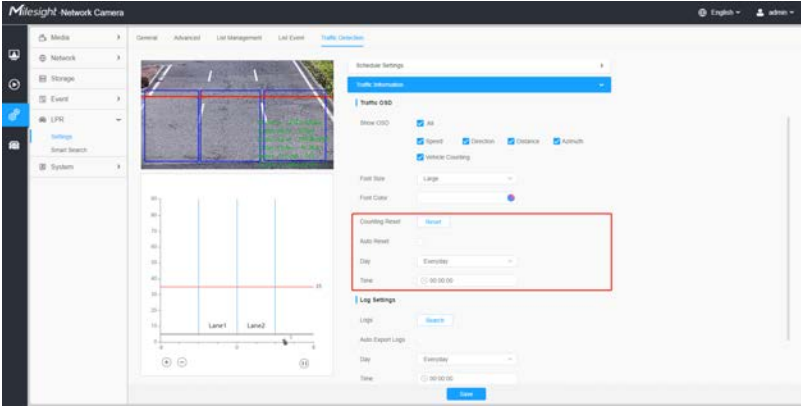
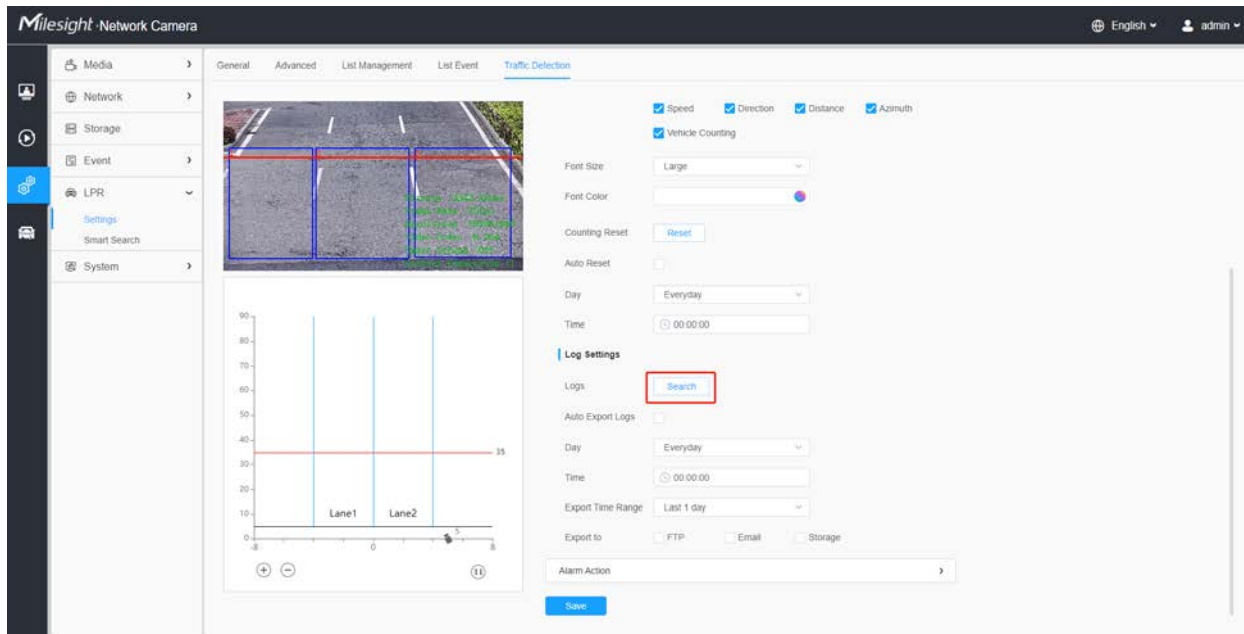

Table 139. Description of the buttons

Parameters	Function Introduction
<p>Show OSD</p>	<p>Users can choose the information they want to display in Live Video, including Speed, Direction, Distance, Azimuth and Vehicle Counting.</p>
<p>Font Size&Font Color</p>	<p>The font size and color of the OSD display, the default size is Medium;</p> <p>When Speed, Direction, and Vehicle Counting are checked, the Live View interface is displayed as shown in the figure below:</p> 
<p>Counting Reset</p>	<p>Click the "Reset" button to manually reset the vehicle count.</p>
<p>Auto Reset</p>	<p>It is used to automatically clear the vehicle count at regular intervals (Just reset the OSD count for Live Video). After it is enabled, the interface is as shown in the figure below, just follow the prompts to set it.</p> 

Step6: Log Settings.

Click the "Edit" button, and a pop-up window as shown in the figure below will appear, allowing users to search for various types of logs and supporting the log export function.



Radar Logs ×

Start Time End Time

Time	Speed	Direction	Distance	Azimuth	Vehicle Counting
2022-06-13 14:06:05	3km/h	Approach	34m	-14°	24140
2022-06-13 14:05:18	4km/h	Approach	34m	-10°	24139
2022-06-13 14:04:16	7km/h	Away	35m	-14°	24138
2022-06-13 14:03:09	54km/h	Away	35m	-3°	24137
2022-06-13 14:02:26	20km/h	Approach	34m	-8°	24136
2022-06-13 14:02:05	13km/h	Approach	34m	-7°	24135
2022-06-13 14:02:04	28km/h	Approach	34m	-11°	24134
2022-06-13 14:02:00	20km/h	Approach	34m	-14°	24133

Total 2710 < 1 2 3 4 5 6 ... 91 >

[Enable Auto Export Logs]: Support regular automatic export of logs to FTP, Email and Storage.

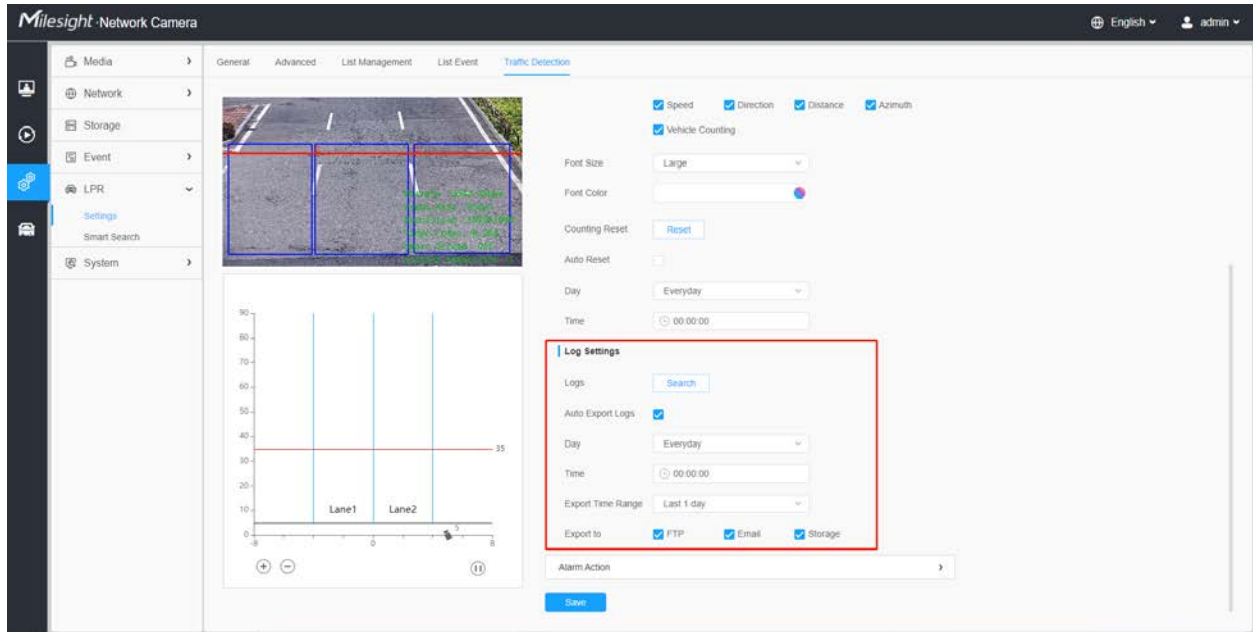

Step7: Traffic Alarm Threshold.

Used to set traffic alarm thresholds, such as maximum and minimum speed limits, and vehicle counting limits.

- OSD Blink

You need to enable the corresponding OSD first as shown in Figure 19. And then when an alarm is triggered, the OSD information will flash and alarm, and you can also set the duration of the OSD Blink Time, which supports 1~10s.

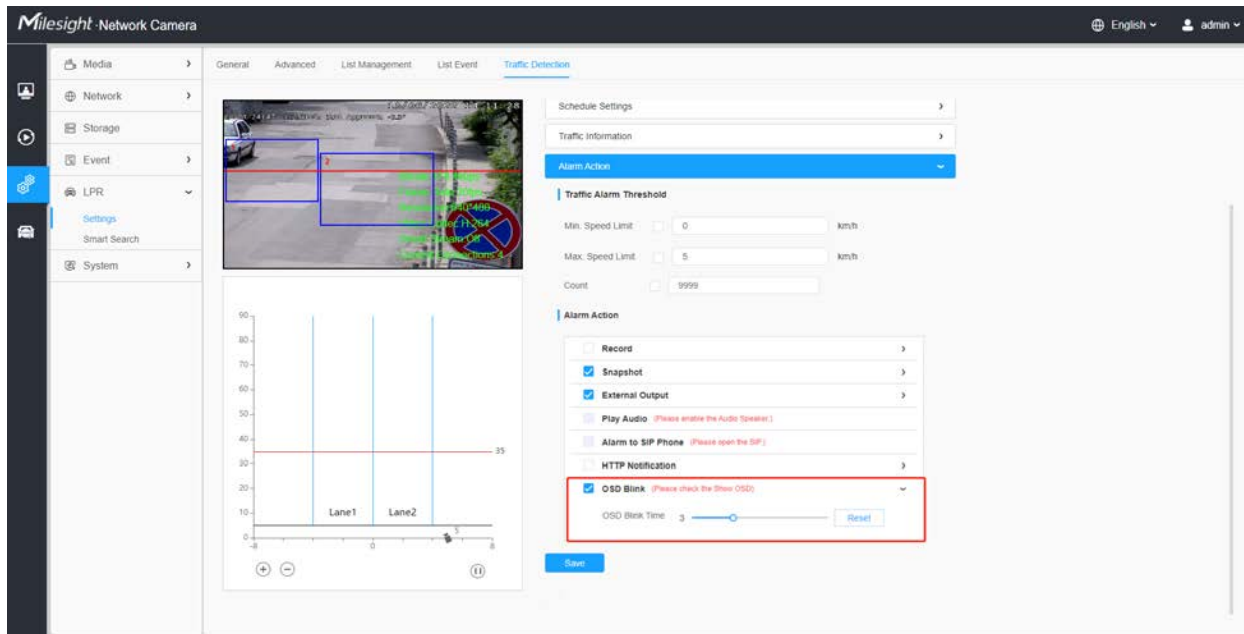

- Send Email

You need to configure the correct email information first. And then when an alarm is triggered, it will send the detection result to the corresponding email as shown below, including the license plate number, event type, vehicle speed, etc.

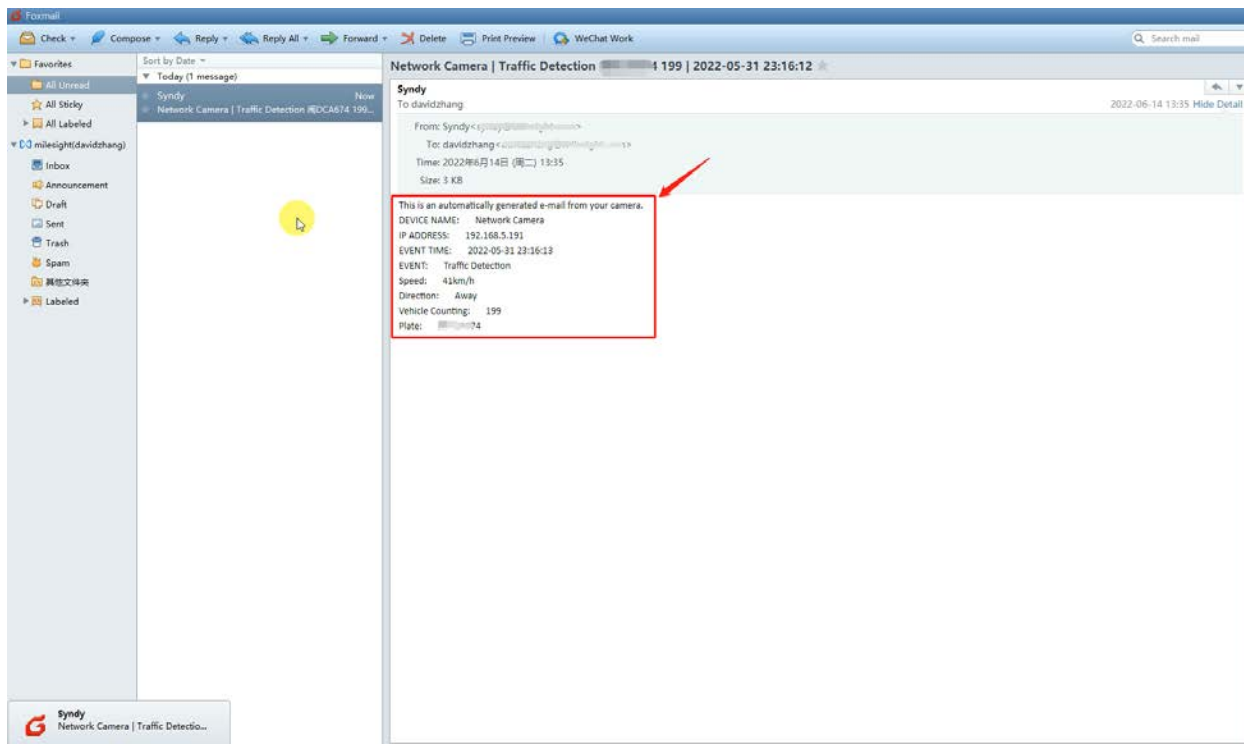

Smart Search

The real-time detection results will be displayed on the right side of Smart Search page, including detected time, live screenshot, license plate and vehicle attributes.

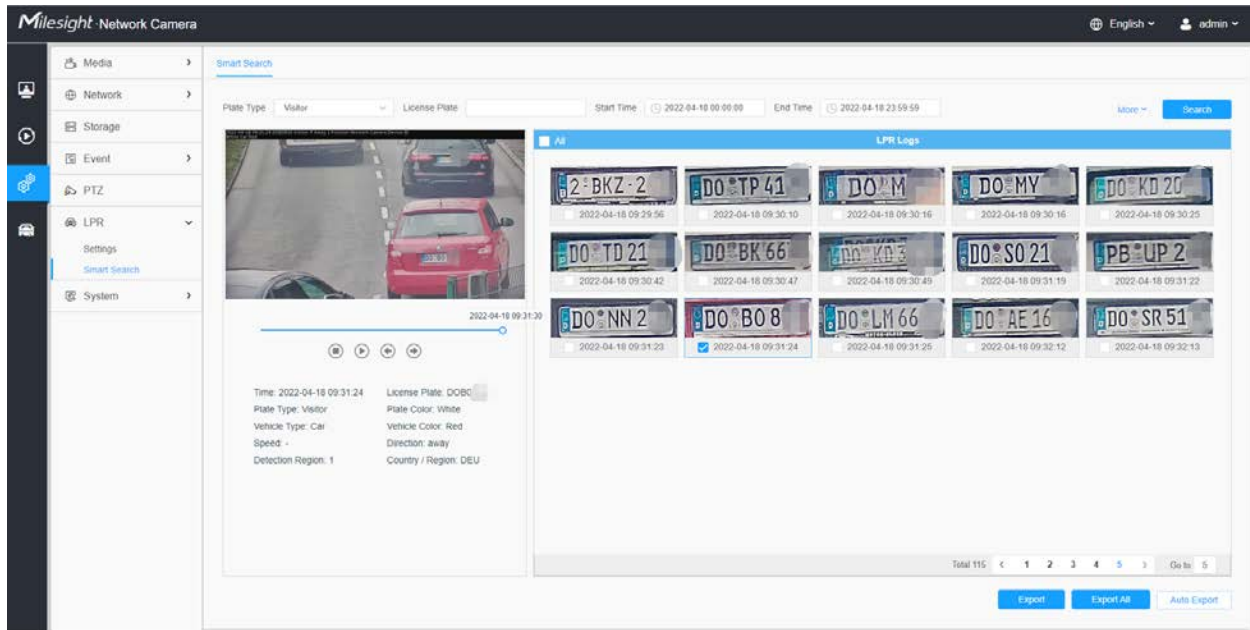



Step1: Select Plate Type and Vehicle Attributes or directly enter the license plate number and then select Start Time and End Time. The related license plate information will be displayed as below by one click on the “**Search**” button.

Note:

- It supports displaying 4,000 logs.
- Only when there is a SD Card or NAS has been set on the storage management , then the logs can be stored and showed on Smart Search page.

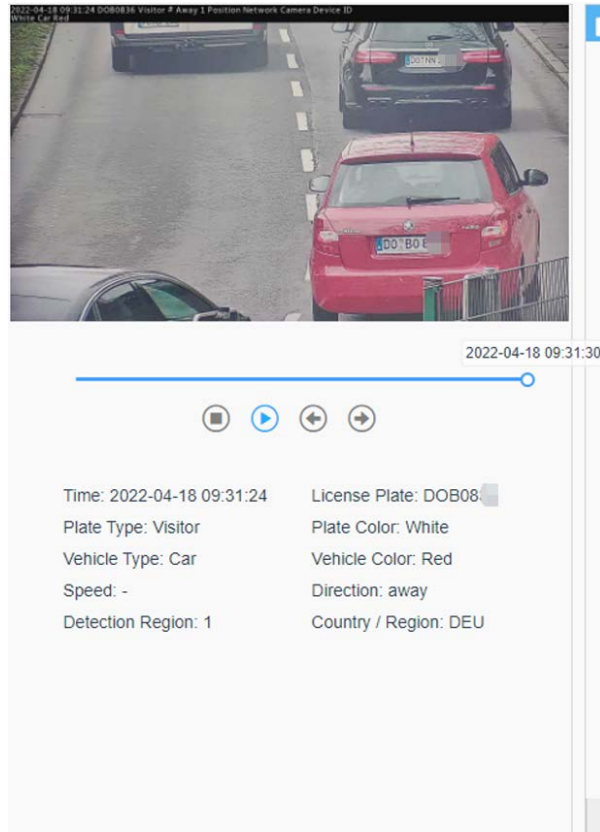
Step2: Click on the thumbnail photo under the LPR Logs, then the license plate details will be shown as below :



 **Note:** If the evidence feature is enabled, you can also click the arrow button on the snapshot to check the image captured by the evidence camera.

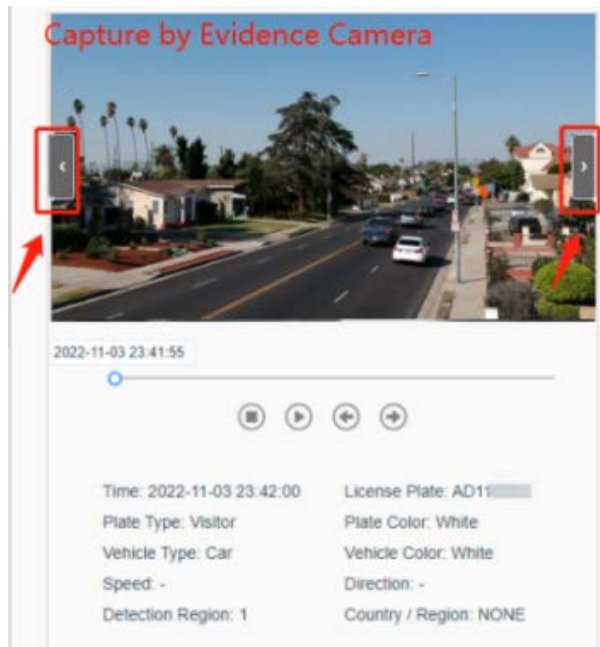

Step3: Click the "Export" or "Export All" button to export the desired files in the current list to a local folder.

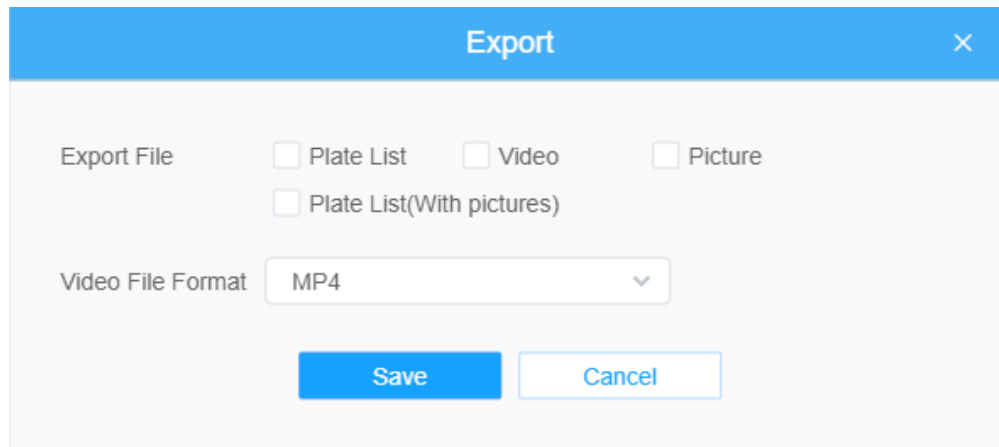

The "Export" dialog box features a blue header with the title "Export" and a close button (X). Below the header, the "Export File" section contains four checkboxes: "Plate List", "Video", "Picture", and "Plate List(With pictures)". The "Video File Format" section includes a dropdown menu currently set to "MP4". At the bottom, there are two buttons: a blue "Save" button and a white "Cancel" button with a blue border.

Step4: Click the "Auto Export" button to automatically export the logs to FTP, Email or Storage.

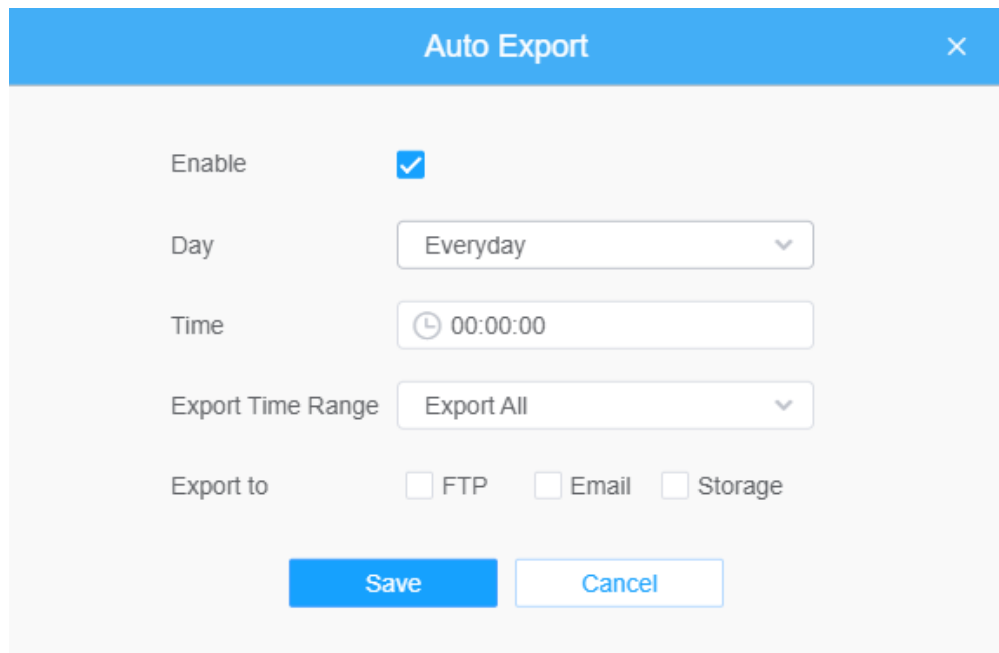

The "Auto Export" dialog box has a blue header with the title "Auto Export" and a close button (X). The "Enable" checkbox is checked. The "Day" dropdown is set to "Everyday". The "Time" field shows a clock icon and "00:00:00". The "Export Time Range" dropdown is set to "Export All". The "Export to" section has three checkboxes: "FTP", "Email", and "Storage", all of which are unchecked. At the bottom, there are two buttons: a blue "Save" button and a white "Cancel" button with a blue border.

3.7.6 System

System Setting

System info

All information about the hardware and software of the camera can be checked on this page.

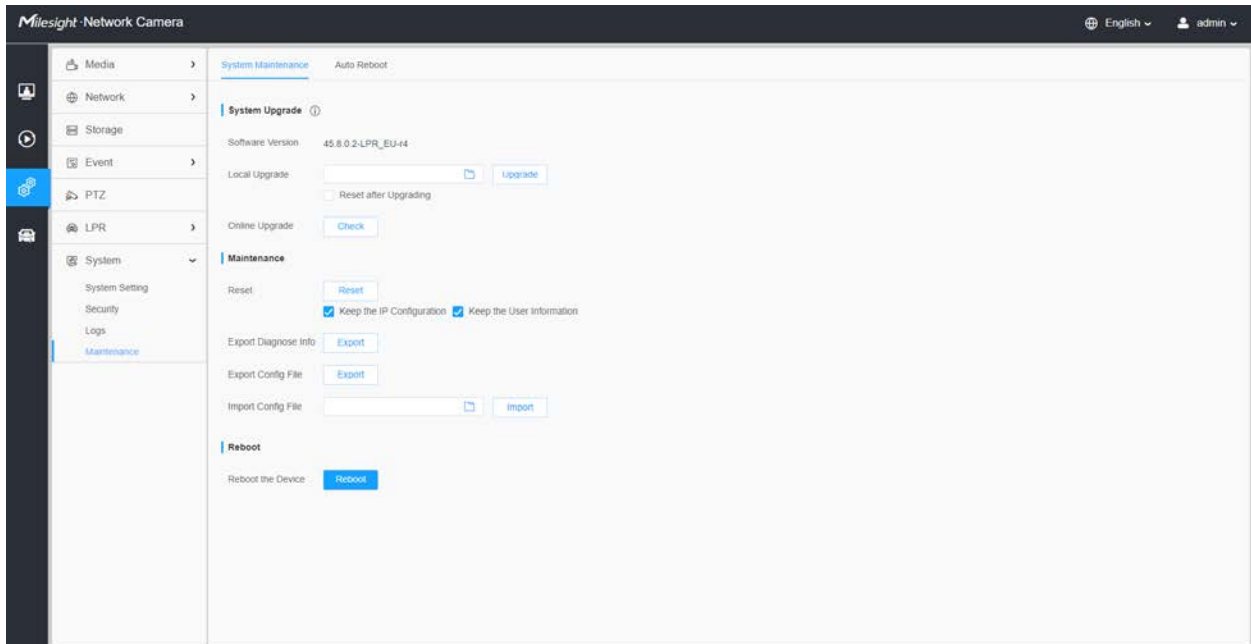







Table 140. Description of the buttons

Parameters	Function Introduction
Device Name	The device name can be customized.
Product Model	The product model of the camera.
Hardware Version	The hardware version of the camera.
Software Version	The software version of the camera can be upgraded.
LPR License (Only for LPR2, LPR3, LPR 4, LPR EU, LPR AP and LPR AM)	Generated by camera's information.  Note: Only for LPR Series.

Parameters	Function Introduction
License Status (Only for LPR2, LPR3, LPR 4, LPR EU, LPR AP and LPR AM)	Show present license status, including Valid and Invalid  Note: Only for LPR Series.
MAC Address	Media Access Control address.
S/N	Stock Number.
Device Information	The device information, including information about alarm I/O and clipper chip.
Alarm Input	The number of Alarm Input interface.  Note: The Alarm Input will appear only when the camera have alarm input/output interface.
Alarm Output	The number of Alarm Output interface.  Note: The Alarm Output will appear only when the camera have alarm input/output interface.
Uptime	The elapsed time since the last restarted of the device.
	Save the configuration.

Date&Time

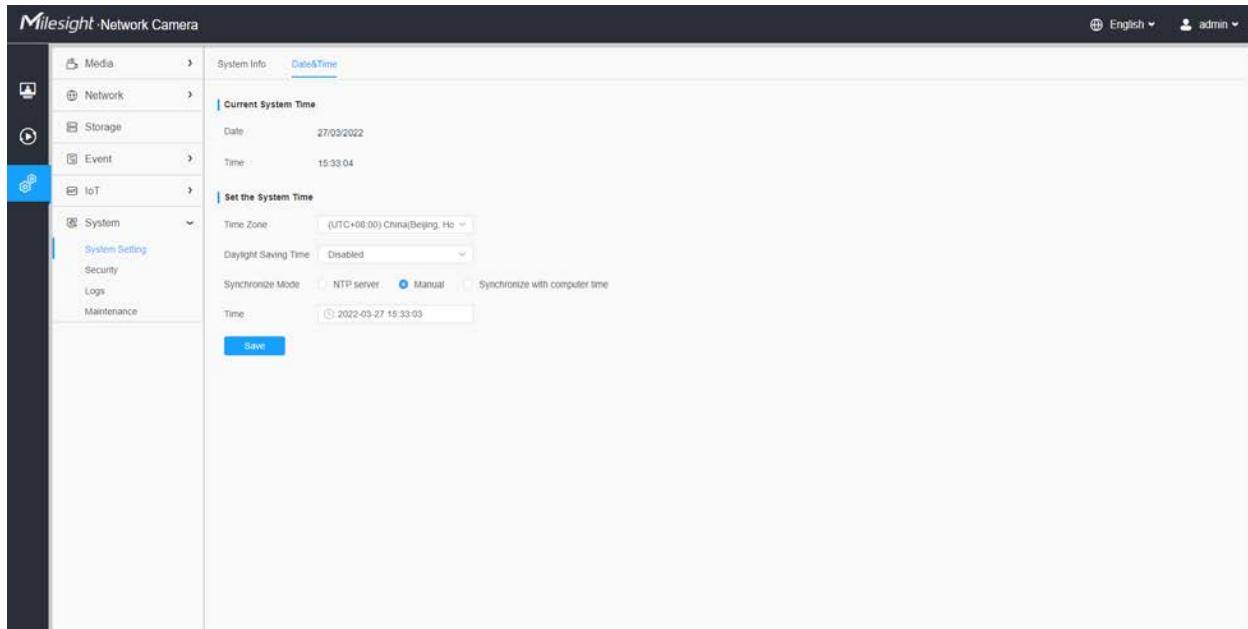

Table 141. Description of the buttons

Parameters	Function Introduction
Current System Time	Current date&time of the system.
Set the System Time	Time Zone: Choose a time zone for your location.
	Daylight Saving time: Enable the daylight saving time.
	Synchronize Mode: NTP server, Manual and Synchronize with computer time are optional.
	NTP server: Input the address of NTP server.
	NTP Sync: Regularly update your time according to the interval time.
	Manual: Set the system time manually.
	Synchronize with computer time: Synchronize the time with your computer.
Save	Save the configuration.

Interfaces

Wiegand

Here you can enable the Wiegand interface for access control. Currently it supports Wiegand 26bit protocol by default.

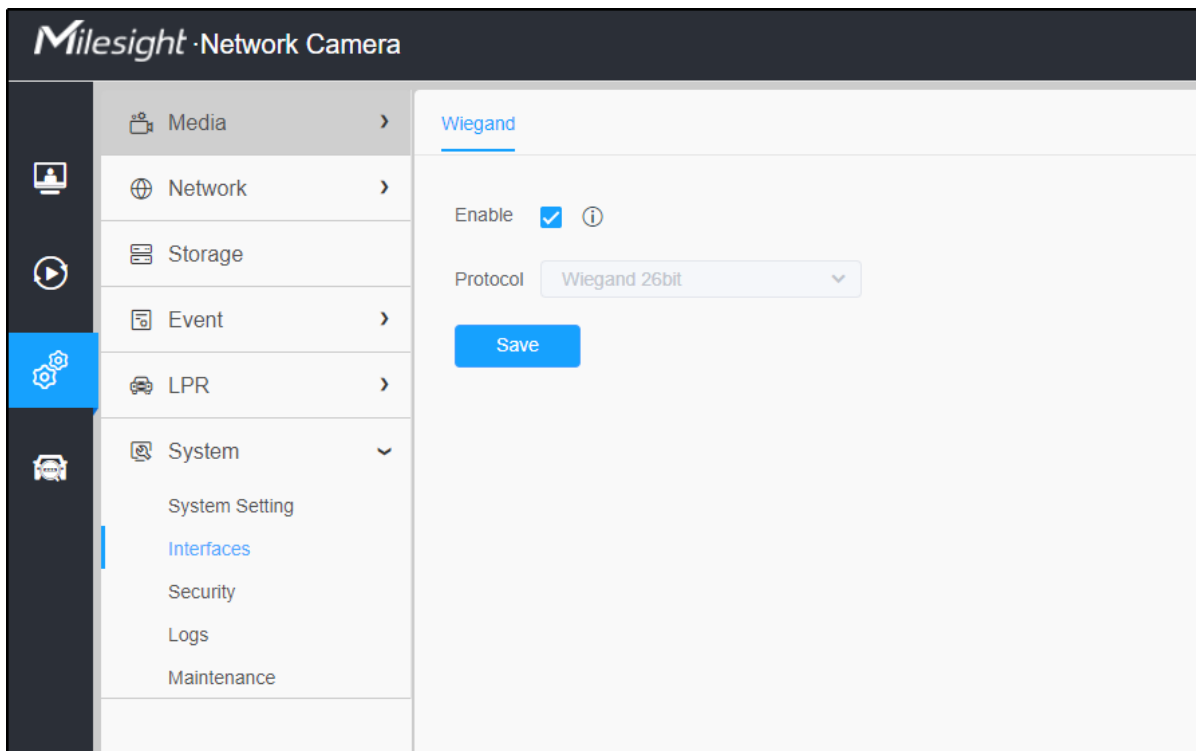

Note: Please make sure the camera has been correctly connected to your parking system through the Wiegand interface as shown below.

- GND and A (Wet contact for External Output).
- A, B and GND (DATA0, DATA1 and GND for Wiegand).

Security

Here you can configure User, Access List, Security Service, Watermark, etc.

User

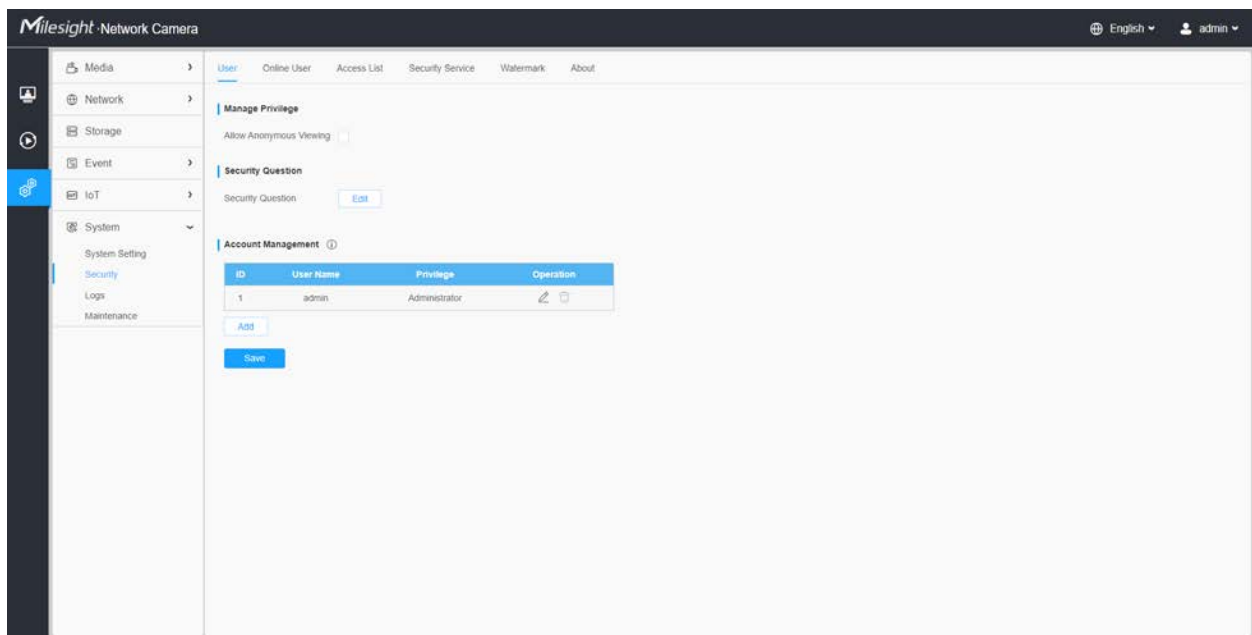



Table 142. Description of the buttons

Parameters	Function Introduction
Manage Privilege	Allow anonymous viewing: Check the checkbox to enable visit from whom doesn't have account of the device.

Parameters	Function Introduction
<p>Security Question</p>	<p>Click "Edit" button to set three security questions for your camera. In case that you forget the password, you can click "Forget Password" button on login page to reset the password by answering three security questions correctly.</p> <div data-bbox="532 411 1330 1058" style="border: 1px solid #ccc; padding: 10px; margin: 10px 0;"> <div style="background-color: #007bff; color: white; padding: 5px; display: flex; justify-content: space-between; align-items: center;"> Security Question Settings × </div> <div style="margin-top: 10px;"> <p>Admin Password* <input type="password"/></p> <p>Security Question1 <input type="text" value="What's your father's name?"/></p> <p>Answer1* <input type="text"/></p> <p>Security Question2 <input type="text" value="What's your father's name?"/></p> <p>Answer2* <input type="text"/></p> <p>Security Question3 <input type="text" value="What's your father's name?"/></p> <p>Answer3* <input type="text"/></p> <div style="display: flex; justify-content: center; gap: 20px; margin-top: 10px;"> Save Cancel </div> </div> </div> <p>There are twelve default questions below, you can also customize the security questions.</p> <div data-bbox="532 1171 1330 1619" style="border: 1px solid #ccc; padding: 10px; margin: 10px 0;"> <div style="border-bottom: 1px solid #ccc; padding-bottom: 5px; margin-bottom: 5px;"> <input type="text" value="What's your father's name?"/> </div> <div style="display: flex; gap: 10px;"> <div style="border: 1px solid #ccc; padding: 5px; width: 45%;"> <p style="background-color: #e9ecef; padding: 2px 5px; margin: 0;">What's your father's name?</p> <p style="padding: 2px 5px; margin: 0;">What's your favorite sport?</p> <p style="padding: 2px 5px; margin: 0;">What's your mother's name?</p> <p style="padding: 2px 5px; margin: 0;">What's your mobile number?</p> <p style="padding: 2px 5px; margin: 0;">What's your first pet's name?</p> <p style="padding: 2px 5px; margin: 0;">What's your favorite book?</p> <p style="padding: 2px 5px; margin: 0;">What's your favorite game?</p> </div> <div style="border: 1px solid #ccc; padding: 5px; width: 45%;"> <p style="padding: 2px 5px; margin: 0;">What's your favorite food?</p> <p style="padding: 2px 5px; margin: 0;">What's your lucky number?</p> <p style="padding: 2px 5px; margin: 0;">What's your favorite color?</p> <p style="background-color: #e9ecef; padding: 2px 5px; margin: 0;">What's your best friend's name?</p> <p style="padding: 2px 5px; margin: 0;">Where did you go on your first trip?</p> <p style="padding: 2px 5px; margin: 0;">Customized Question</p> </div> </div> </div>

Parameters	Function Introduction
<p style="text-align: center;">Account Management</p>	<p>Click “Add” button, it will display Account Management page. You can add an account to the camera by entering Admin Password, User Level, User Name, New Password, Confirm, and edit user privilege by clicking . The added account will be displayed in the account list.</p> <p>Admin Password: You can add an account only after you enter the correct admin password.</p> <p>User Level: Set the privilege for the account.</p> <p>User Name: Input user name for creating an account.</p> <p>New Password: Input password for the account.</p> <p>Confirm: Confirm the password.</p> <p>You can edit and delete the account in the account list under the admin account. For the default admin account, you can only change the password, and it cannot be deleted.</p> <p> Note:</p> <ul style="list-style-type: none"> • Support up to 20 users, including a default user and 19 custom added users. • The operator privilege is all checked by default.

Online User

Here real-time status of user logging in camera will be shown.

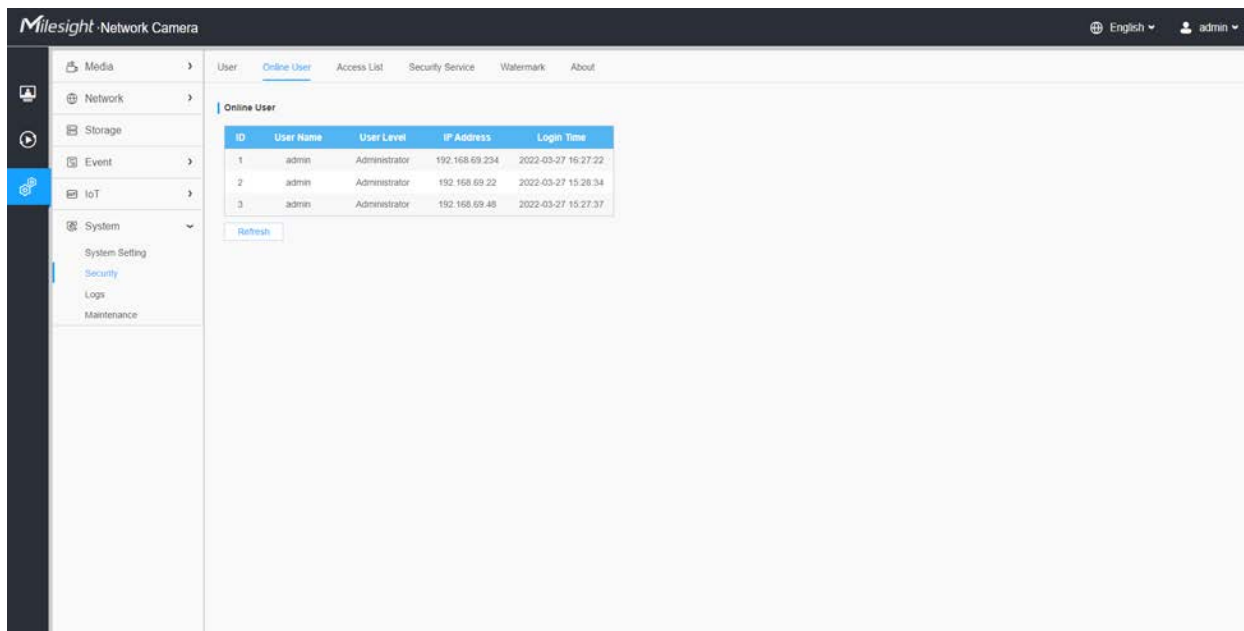



Table 143. Description of the buttons

Parameters	Function Introduction
Refresh	Click to get latest status of user accessing to camera.
ID	Record serial number of user logging in camera.  Note: <ul style="list-style-type: none"> • There are at most 30 records shown at the list. • There is only one record if the same user logs in camera by the same IP address.
User Name	Name of user logging in camera.
User Level	Level of user logging in camera.
IP Address	Device IP address where user logging in camera web located.
Login Time	Camera system time of user logging in camera.

Access List

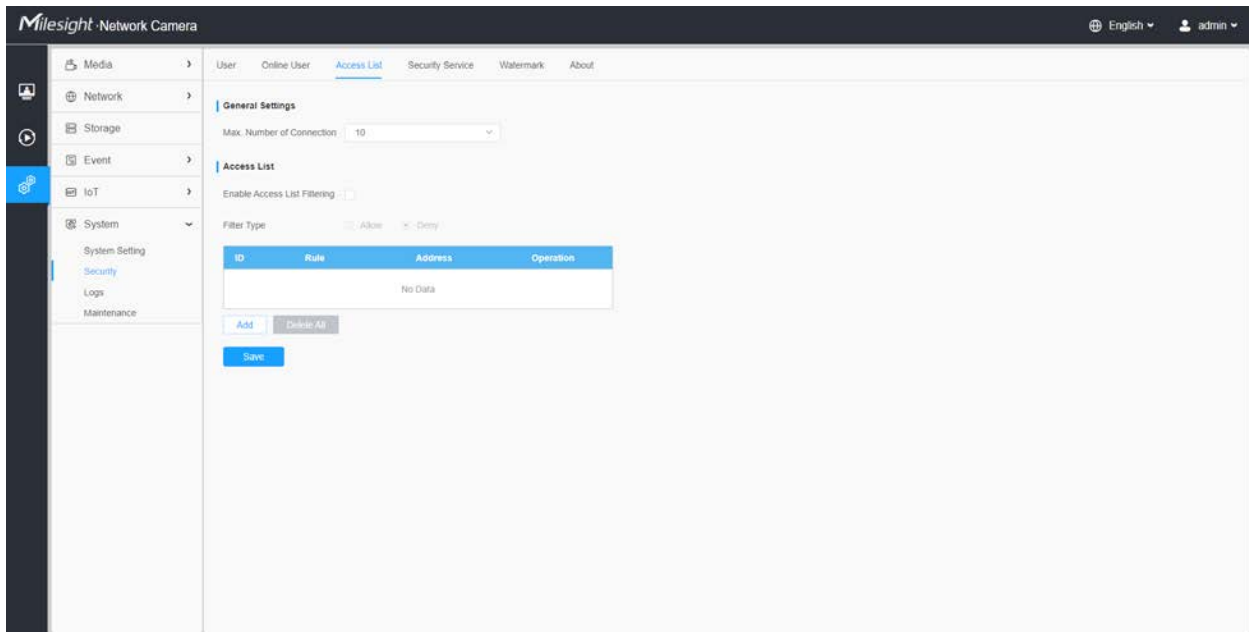
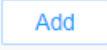
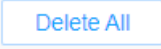

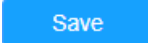

Table 144. Description of the buttons

Parameters	Function Introduction
General Settings	Max. Number of Connection: Select the maximum number of concurrent streaming. Options include No Limit, 1~10.
Access List	Enable Access List Filtering: Able to access or restrict access for some IP address.

Parameters	Function Introduction	
Access List	Filter type: Allow or deny access.	
		Rule: Single, Network and Range are available. IP address: Input the address to get the access to the device.
		Delete all the access list.
		Edit the selected IP on access list.
		Delete the selected IP on access list.
	Save the configuration.	

Security Service

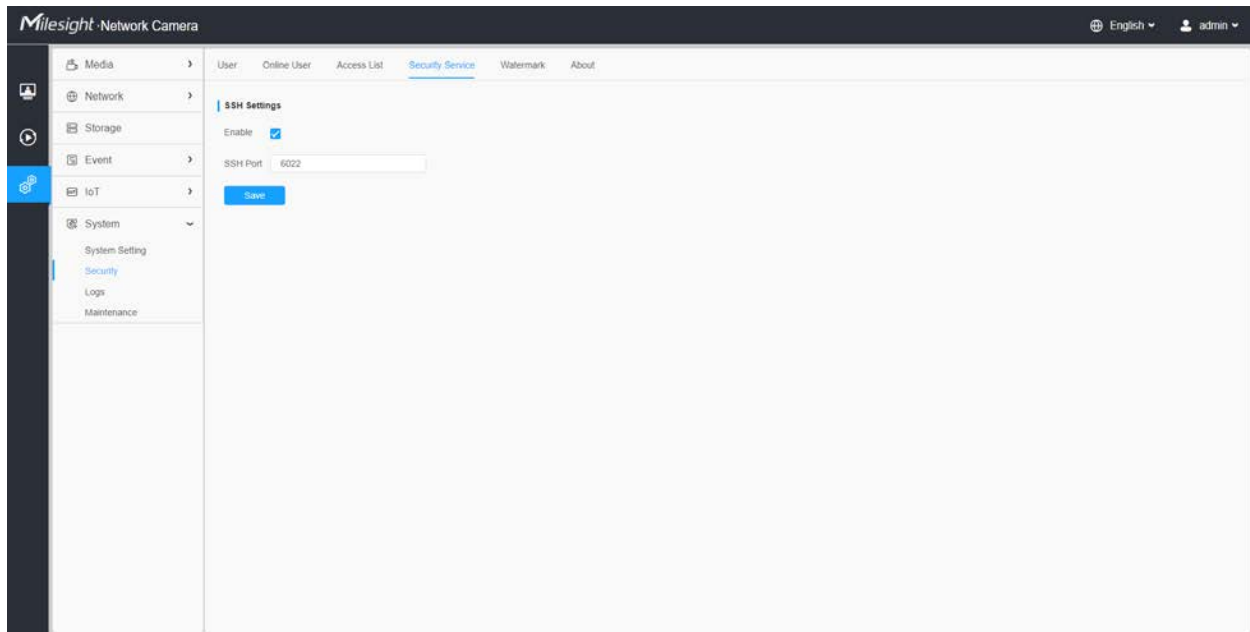
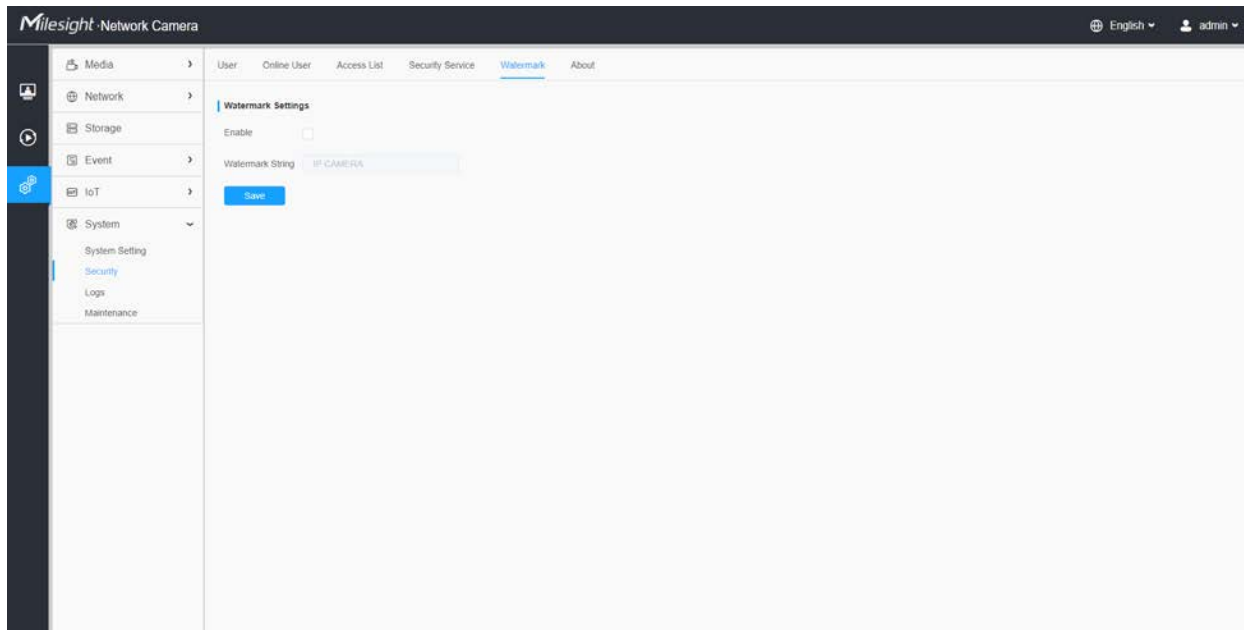

Table 145. Description of the buttons

Parameters	Function Introduction
SSH Settings	Secure Shell (SSH) has many functions: it can replace Telnet and also provides a secure channel for FTP, POP, even for PPP.

Watermark



Watermarking is an effective method to protect information security, realizing anti-counterfeiting traceability and copyright protection. Milesight Network cameras supports Watermark function to ensure information security.

About

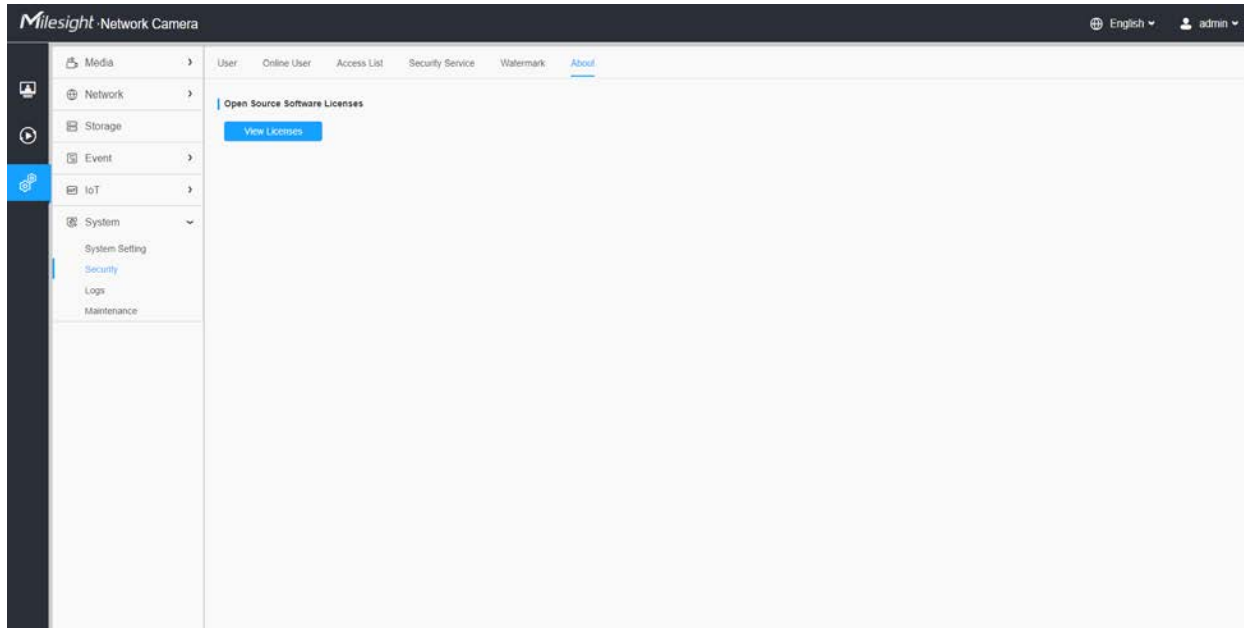

User can view some open source software licenses about the camera by clicking the View Licenses button.

Logs

The logs contain the information about the time and IP that has accessed the camera through web.

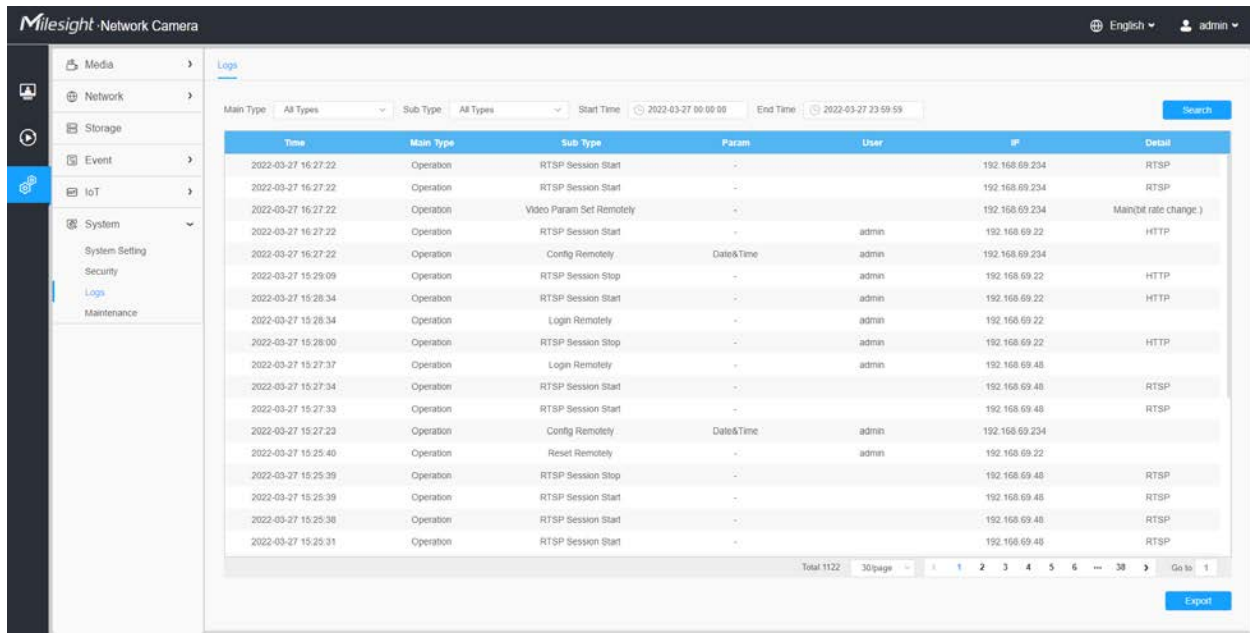
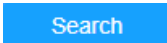



Table 146. Description of the buttons

Parameters	Function Introduction
Main Type	There are five main log types: All Type , Event , Operation , Information , Exception and Smart .
Sub Type	On the premise that main type has been selected, select the sub type to narrow the range of logs.
Start Time	The time log starts.
End Time	The time log ends.
	Search the logs.
	Export the logs.

Parameters	Function Introduction
Go to	Input the number of logs' page.

Maintenance

Here you can configure System Maintenance and Auto Reboot.

System Maintenance

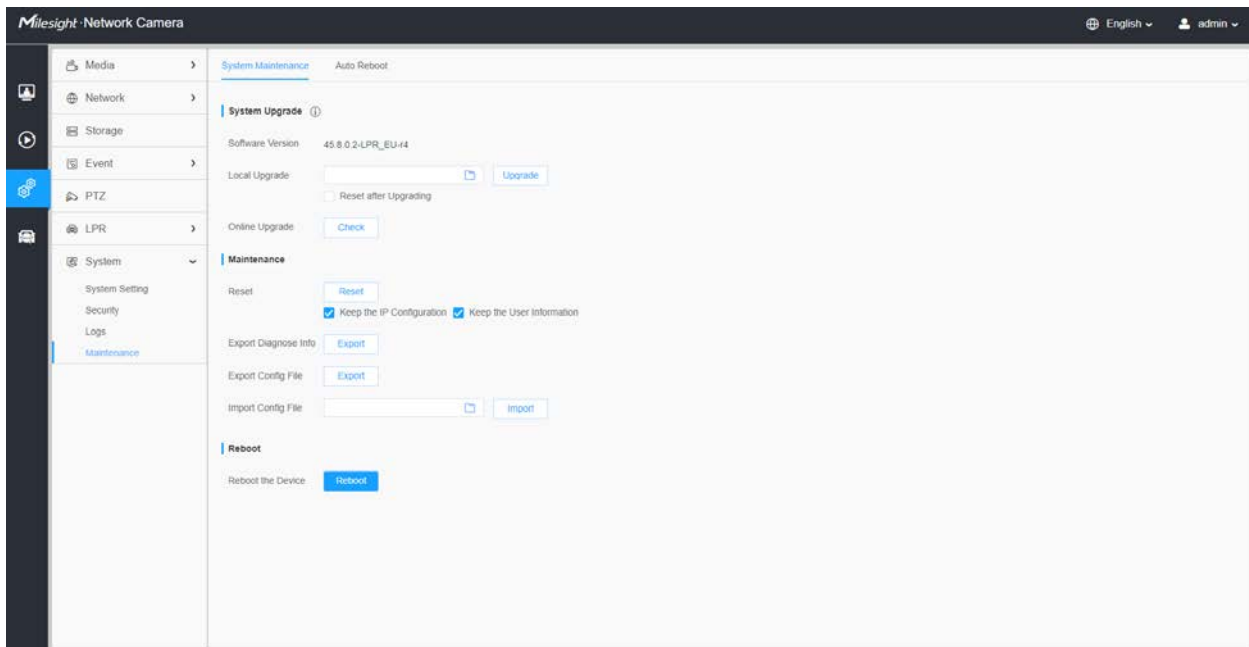



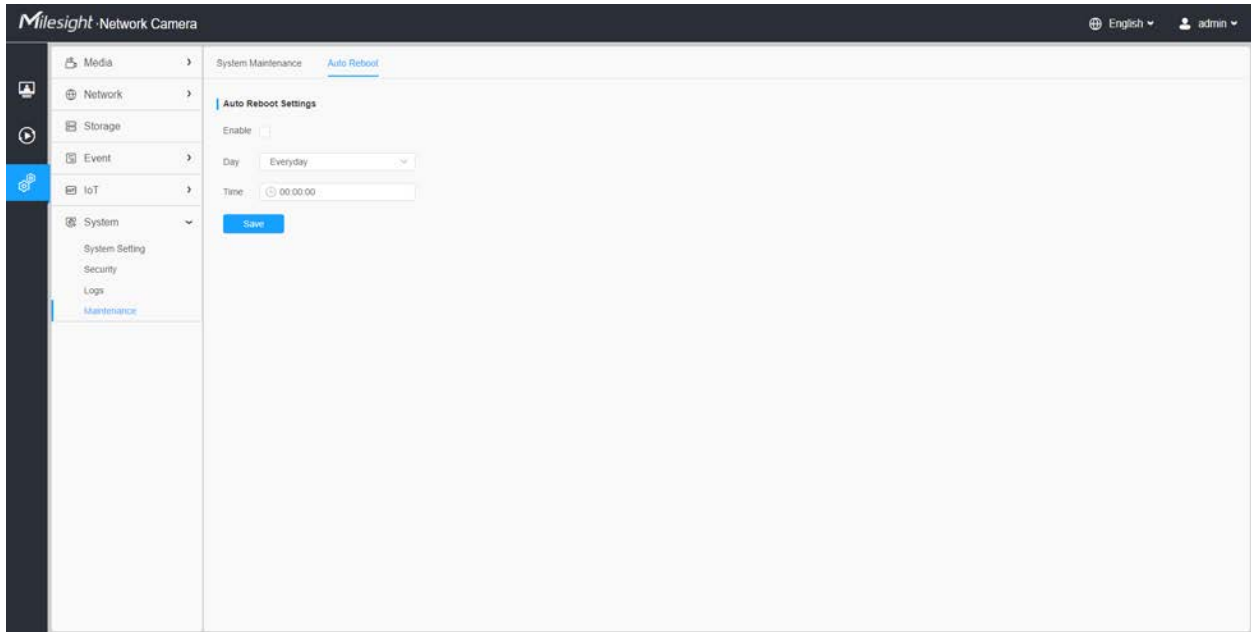

Table 147. Description of the buttons

Parameters	Function Introduction
<p>System Upgrade</p>	<p>Software Version: The software version of the camera.</p> <p>Local Upgrade: Click the "Browse" button and select the upgrading file, then click the "Upgrade" button to upgrade. After the system reboots successfully, the update is done.</p> <p>You can check "Reset after Upgrading" to reset the camera after upgrading it.</p> <p>Online Upgrade: Click the "Check" button to check the current latest firmware version on our website, and then click "OK" to upgrade to this version.</p> <p>It will prompt "The current version is the latest version" if your camera is already the latest version.</p> <div data-bbox="592 709 1188 1008" style="border: 1px solid #ccc; padding: 10px; margin: 10px 0;"> <div style="background-color: #007bff; color: white; padding: 5px; display: flex; justify-content: space-between; align-items: center;"> Tips × </div> <div style="text-align: center; margin-top: 10px;">  <p>The current version is the latest version.</p> <div style="margin-top: 10px; display: inline-block; background-color: #007bff; color: white; padding: 5px 15px; border-radius: 5px;">OK</div> </div> </div> <p> Note: Do not disconnect the power of the device during the update. The device will be restarted to complete the upgrading.</p>

Parameters	Function Introduction
<p style="text-align: center;">Maintenance</p>	<p>Reset: Click "Reset" button to reset the camera to factory default settings.</p> <p>Keep the IP Configuration: Check this option to keep the IP configuration when resetting the camera.</p> <p>Keep the User information: Check this option to keep the user information when resetting the camera.</p> <p>Export Diagnose Info: Click this button to export logs and system information of the device operation status.</p> <p> Note: The file format is ".txt".</p> <p>Export Config File: Click this button and a window will pop up as shown below:</p> <div data-bbox="591 732 1390 1062" style="border: 1px solid #ccc; padding: 10px; background-color: #f9f9f9;"> <div style="background-color: #0070c0; color: white; padding: 5px; display: flex; justify-content: space-between;">File Encryption Configuration×</div> <div style="padding: 10px;"> <p>Input the encryption password <input style="width: 100%;" type="text"/></p> <p>Confirm <input style="width: 100%;" type="text"/></p> <div style="display: flex; justify-content: center; gap: 20px;"> Save Cancel </div> </div> </div> <p>You need to enter and confirm password again, then click save button to export configuration file.</p> <p>Import Config File: Click this button, then a window will pop up and you can click "OK" to update the configuration.</p> <p>It will pop up a window to prompt "Input the password of config file" , then enter password and click save button to import configuration file.</p> <div data-bbox="591 1329 1390 1587" style="border: 1px solid #ccc; padding: 10px; background-color: #f9f9f9;"> <div style="background-color: #0070c0; color: white; padding: 5px; display: flex; justify-content: space-between;">File Encryption Configuration×</div> <div style="padding: 10px;"> <p>Input the encryption password <input style="width: 100%;" type="text"/></p> <div style="display: flex; justify-content: center; gap: 20px;"> Save Cancel </div> </div> </div> <p> Note:</p> <p>Export and import the same configuration file. Password must be the same.</p>

Auto Reboot



Set the date and time to enable Auto Reboot function, the camera will reboot automatically according to the customized time in case that camera overload after running a long time.

Chapter 4. Parking Management

4.1 Product Description

4.1.1 Product Overview

Milesight AI Outdoor Parking Management Pro Bullet Plus Camera is designed for outdoor parking management. High-accuracy outdoor parking space detection based on AI algorithm enables simultaneous detection and management of up to 100 parking spaces. Besides, excellent scene adaptability realizes 24/7 parking management surveillance to help guide parking for more efficient and intelligent parking management. Make parking easy and smart!

4.1.2 Related Product

Table 148.

Product	Name
	AI Outdoor Parking Management Pro Bullet Plus Camera

4.1.3 Hardware Overview

- AI Outdoor Parking Management Pro Bullet Plus Camera

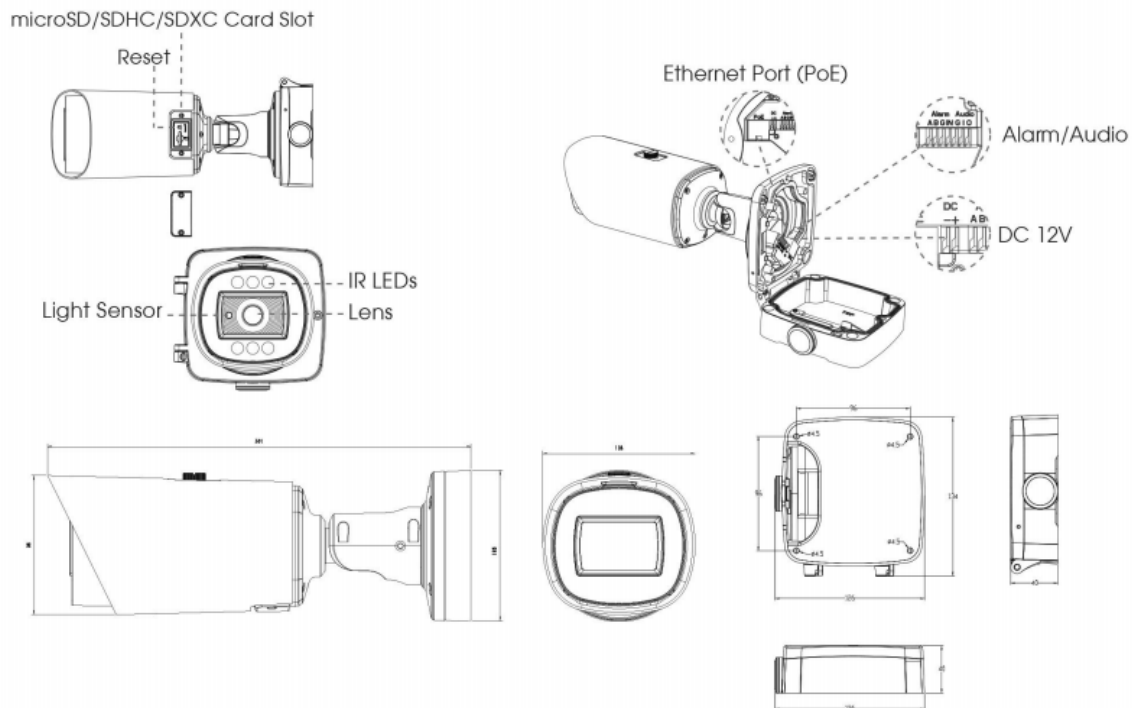

4.1.4 Benefits of the Camera

- **Intelligent AI Parking Space Detection Algorithm**

High-accuracy outdoor parking space detection based on AI algorithm can realize simultaneous detection and management of up to 100 parking spaces with up to 98% detection accuracy, which greatly helps guide parking and realizes more efficient and intelligent parking management.

- **Excellent Scene Adaptability**

With a series of cutting-edge image technologies, AI Outdoor Parking Management Pro Bullet Plus Camera has excellent scene adaptability. The wide field of view of the motorized zoom lens allows for a wider monitoring range, while the 4K resolution ensures that the images are sharp enough. In addition, under the 1/1.8" STARVIS starlight sensor and image-based frame accumulation technology, it also ensures the detection of parking lots at night, providing 24/7 surveillance monitoring.

- **High compatibility**

To maximize the usability and compatibility, the AI Outdoor Parking Management Pro Bullet Plus Camera supports CGI/APIs, which allows the easy open integration with

third-party platforms. The network protocol such as HTTP(s) offers a wide range of options for data processing. The parking information is transmitted to the third-party parking system to help form a complete set of solutions, guide the driver to find the parking space quickly and realize intelligent management.

- **Unique Structure Design**

The unique structure design of the camera enlarges the space and greatly saves efforts for installers, such as the integrated cable management bracket. And the IP67-rated weather proofing and IK10-rated vandal proofing allow to protect the camera against adverse impacts to ensure the robust performance.

- **Flexible Configuration**

The configuration of Parking Space Detection is very flexible and convenient. Area Name, Planned Spaces of Area, Distribution and Numbering Scheme of the detection area can be customized, which provides a easy detection area configuration method and conforms to user habits. And the red overlay of the occupied parking space provides a more intuitive interface.

4.1.5 Installation Guide

Installation Suggestions

1. The installation angle should not be too small, otherwise the cars will obscure each other. Recommended angle range: 45°~60°.

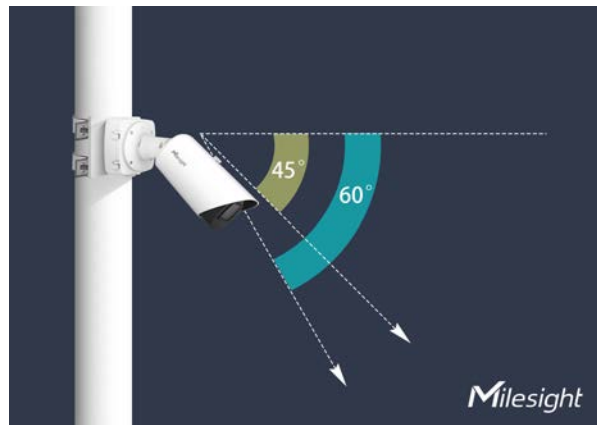

2. The camera should not be installed to shoot against the wide side of the car, or the car will be badly blocked between each other. If it can not be avoided, a very high installation height is needed to prevent obscuring.



3. Recommended installation height: 3.5m~10m. The higher the height, the less obscuring and the better the algorithm accuracy will be.

• **Example 1:**



Table 149. Parking Space Information

Parking Space Size	Lane Width	Number of Parking Spaces
2.5mx5m	5m	7x14=98

Table 150. Camera Information

Number of Cameras	Installation Height	Installation Angle	Min. Distance to Parking Space
1	10m	45°	5m

- **Example 2:**

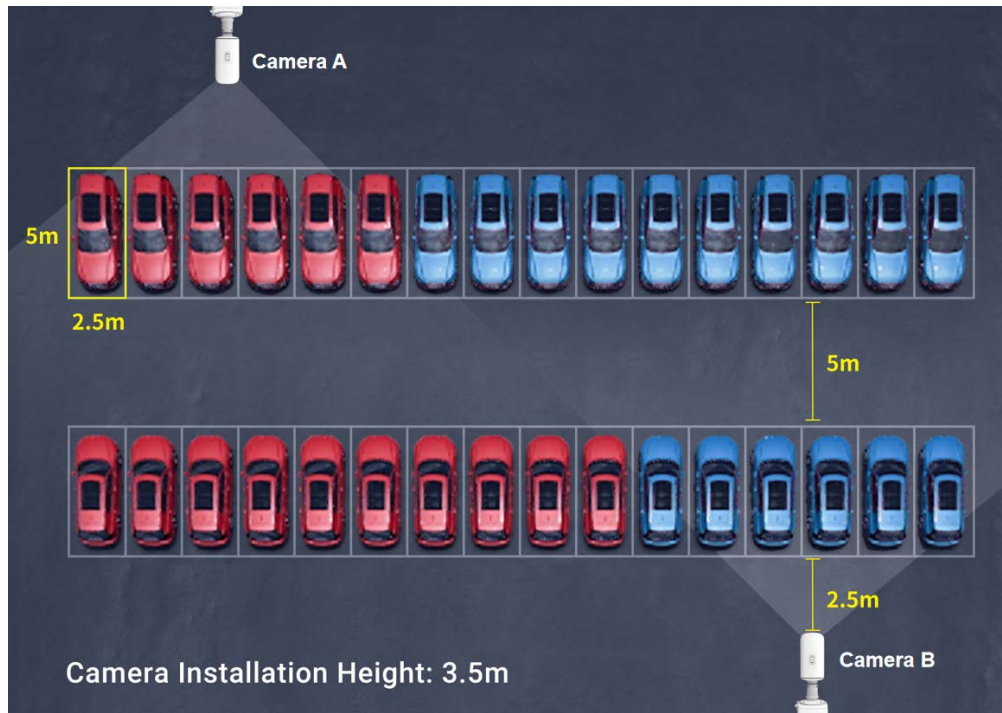

Note: The red car area is detected by Camera A, and the blue car area is detected by Camera B.

Table 151. Parking Space Information

Parking Space Size	Lane Width	Number of Parking Spaces
2.5mx5m	5m	2x16=32

Table 152. Camera Information

Number of Cameras	Installation Height	Installation Angle	Min. Distance to Parking Space
2	3.5m	48°	2.5m

4.1.6 Related Documents

Table 153.

Document Type	Link
	AI Outdoor Parking Management Camera

Document Type	Link
Datasheet	https://www.milesight.com/static/file/en/download/datasheet/ipc/Milesight-AI-Outdoor-Parking-Management-Pro-Bullet-Plus-Camera-Datasheet-en.pdf
Quick Start Guide	https://www.milesight.com/static/file/en/download/user-manual/ipc/Milesight-Network-Camera-Quick-Start-Guide.pdf

4.2 Configuration Flow

The configuration flow of AI Outdoor Parking Management Camera is shown in the following figure.

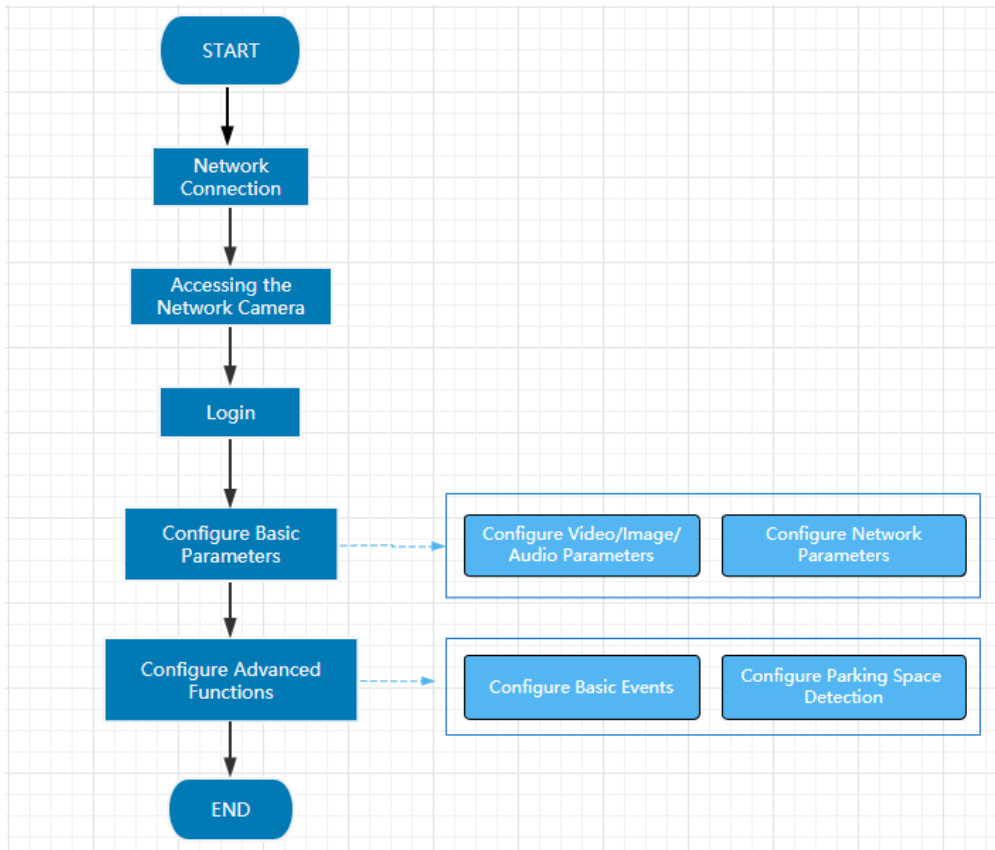

More configuration details is shown in the following table.

Table 154. Description of flow

Configuration	Description	Reference
Network Connection	Connect the network camera. You can set the camera over the LAN or dynamic IP connection.	Setting the Camera over the LAN (page 11)

Configuration	Description	Reference
Accessing the Network Camera	Accessing from IP address, web browser and MileSight back-end software are available.	Assigning an IP Address (page 12)
Configure Basic Parameters	After login the camera, you can adjust the video/image/audio/network parameters as needed.	Video (page 33) Image (page 36)
Configure Advanced Functions	Configure the Basic Event and Parking Space Detection.	Motion Detection (page 82) Parking Management (page 375)

4.3 Network Connection

Setting the Camera over the LAN

Connecting the camera to a switch or a router is the most common connection method. The camera must be assigned an IP address that is compatible with its LAN.

Connect the Camera to the PC Directly

In this method, only the computer connected to the camera will be able to view the camera. The camera must be assigned a compatible IP address to the computer. Details are shown as the following figure.



Connect via a Switch or a Router

Refer to the following figure to set network camera over the LAN via the switch or router.

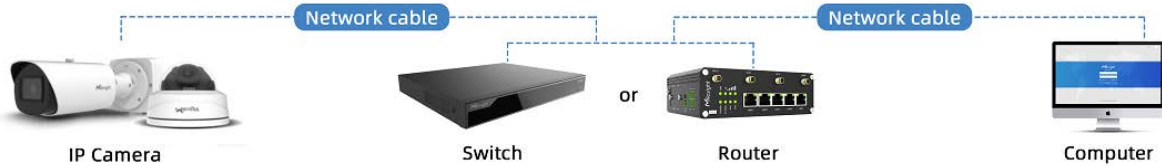

Dynamic IP Connection

Step1: Connect the network camera to a router;

Step2: On the camera, assign a LAN IP address, the Subnet mask and the Gateway;

Step3: On the router, set port forwarding. E.g. 80, 8000 and 554 ports. The steps for port forwarding vary depending on different routers. Please look up the router's user manual for assistance with port forwarding;

Step4: Apply a domain name from a domain name provider;

Step5: Configure the DDNS settings in the setting interface of the router;

Step6: Visit the camera via the domain name.

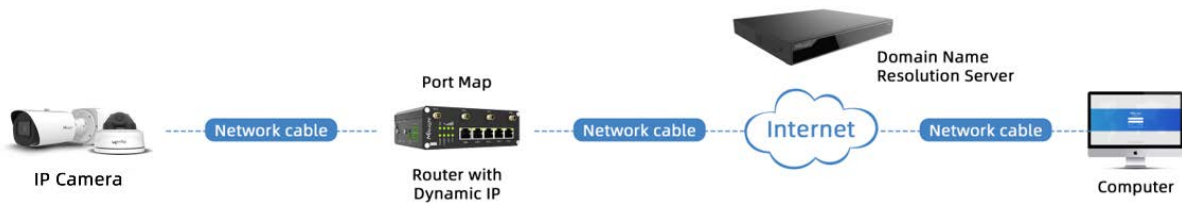

4.4 Accessing the Network Camera

Assigning an IP Address

The Network Camera must be assigned an IP address to be accessible. The default IP address of Milesight network cameras is 192.168.5.190.

You can also change the IP address of the camera via Smart Tools or browser. Please connect the camera in the same LAN of your computer.

Assigning an IP Address Using Smart Tools

Smart Tools is a software tool which can automatically detect multiple online Mileight network cameras in the LAN, set IP addresses, and manage firmware upgrades. It's recommended to use when assigning IP addresses for multiple cameras.

Step1: Install Smart Tools (The software could be downloaded from our website);

Step2: Start Smart Tools, click the IPC Tools page, then enter the device information, such as IP address, MAC address, Status, Port number, Netmask, and Gateway, then all related Mileight network camera in the same network will be displayed. Details are shown as the figure below;

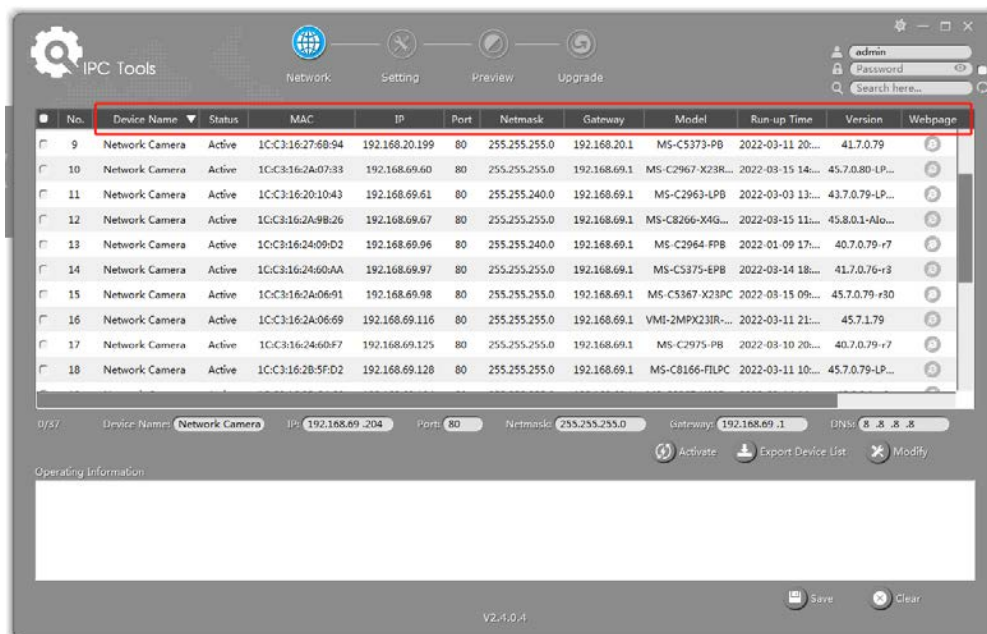

Step3: Select a camera or multiple cameras according to the MAC addresses;

Select single camera:

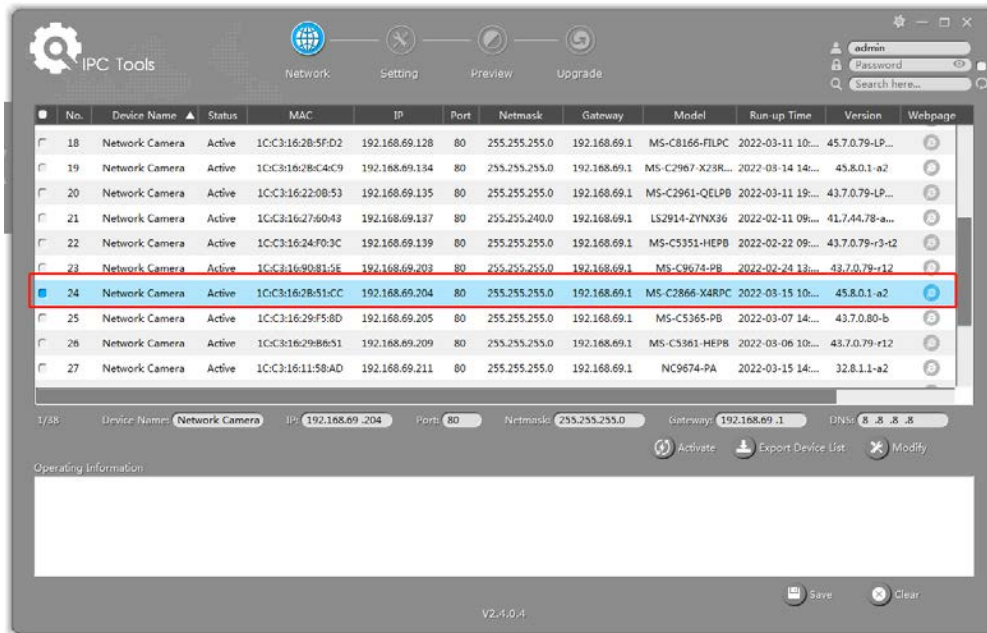

Select multiple cameras:

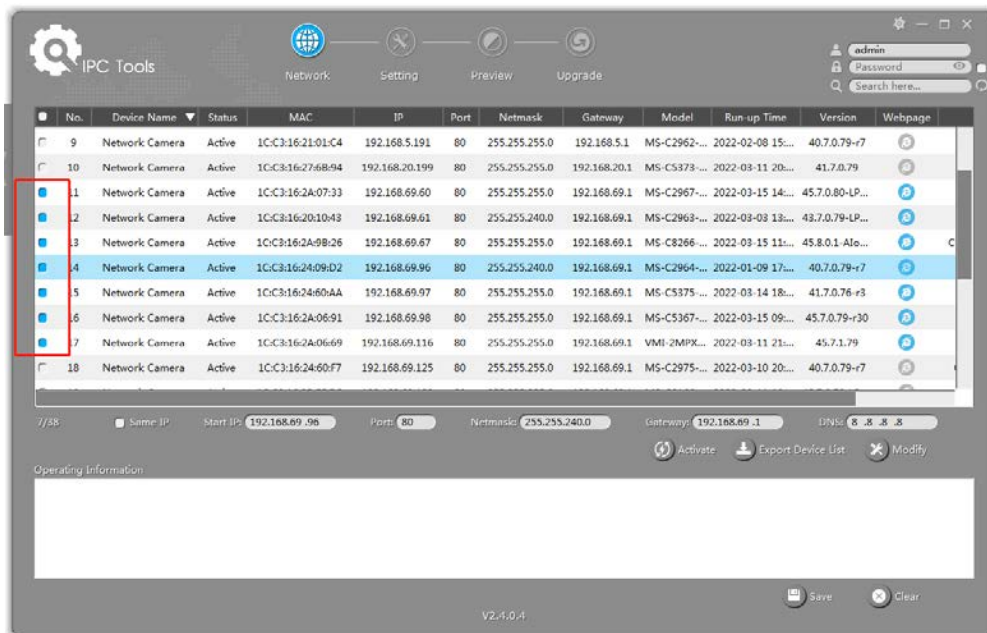

Step4: If the selected camera shows "Inactive" in the status bar, click "Activate" to set the password when using it for the first time. You can also set the security questions when activating the camera in case that you forget the password (You can reset the password by answering three security questions correctly). Click 'Save' and it will show that the activation was successful.

 **Note:**

- Password must be 8 to 32 characters long, contain at least one number and one letter.
- You need to upgrade Smart Tools version to V2.4.0.1 or above to activate the camera.

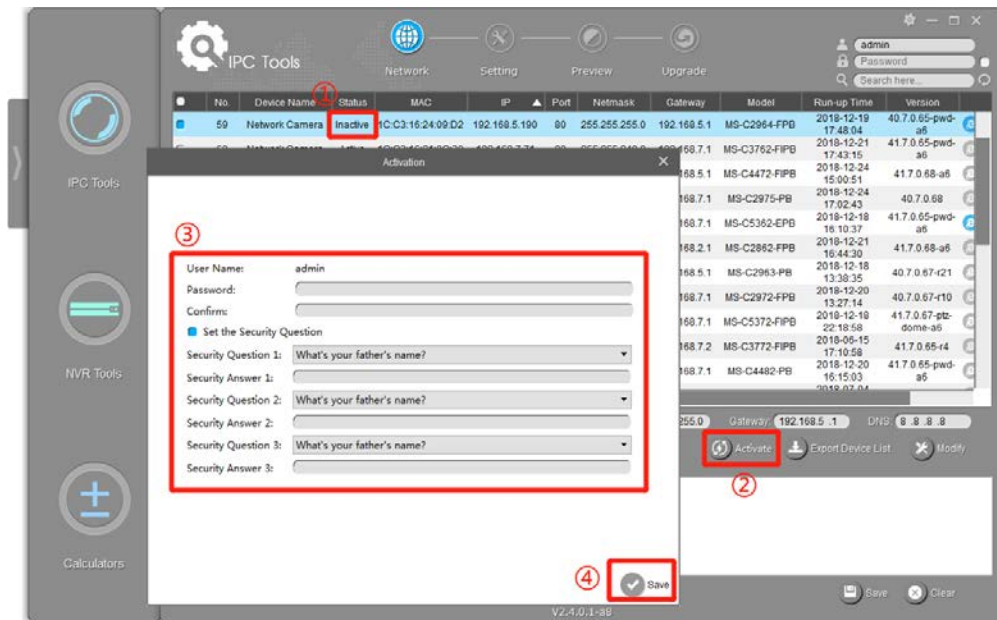

Step5: After activation, you can change the IP address or other network values, and then click "Modify" button.

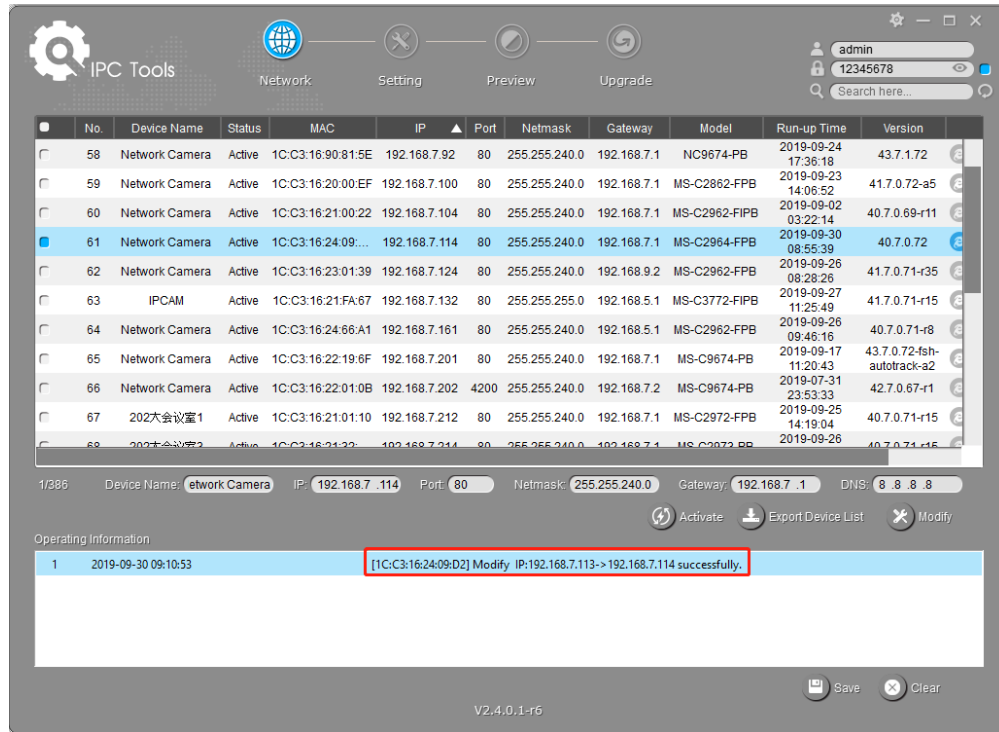

Step6: By double clicking the selected camera or the browser of interested camera, you can access the camera via web browser directly. The Internet Explorer window will pop up.

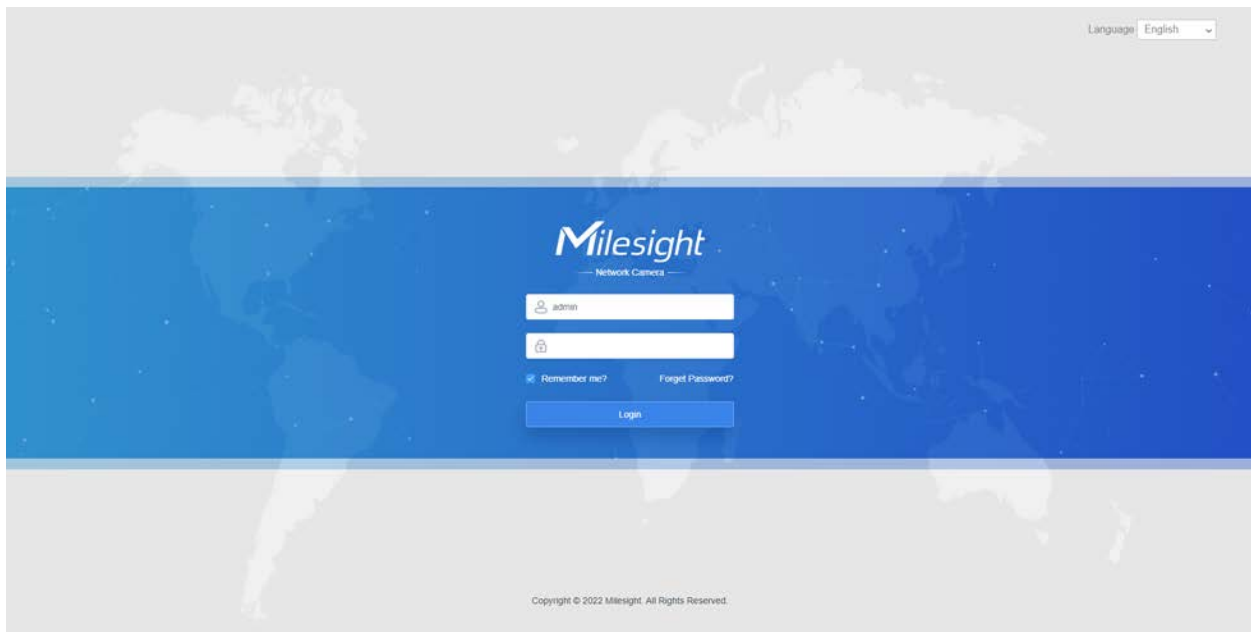

More usage of Smart Tools, please refer to the **Smart Tools User Manual**.

Assign An IP Address via Browser

If the network segment of the computer and that of the camera are different, please follow the steps to change the IP address:

Step1: Change the IP address of computer to 192.168.5.0 segment, here are two ways as below:

a. Start-->Control Panel-->Network and Internet Connection-->Network Connection-->Local Area Connection, and double click it;

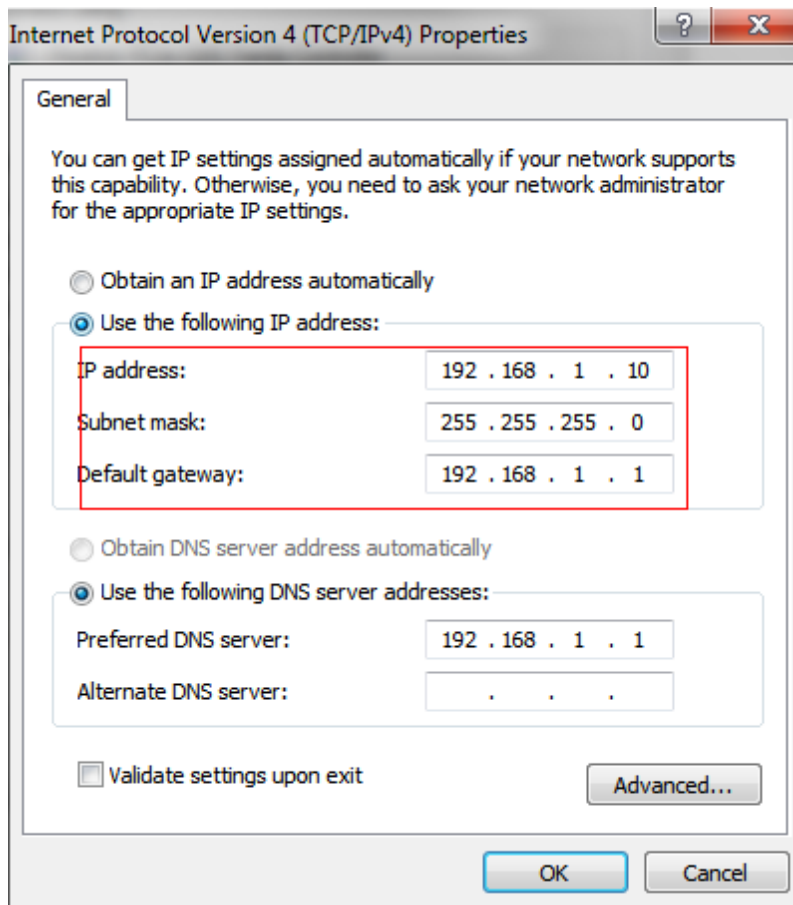

b. Click "Advanced", and then click "IP settings"--> "IP address"--> "Add". In the pop-up window, enter an IP address that in the same segment with Milesight network camera (e.g. 192.168.5.61, but please note that this IP address shall not conflict with the IP address on the existing network);

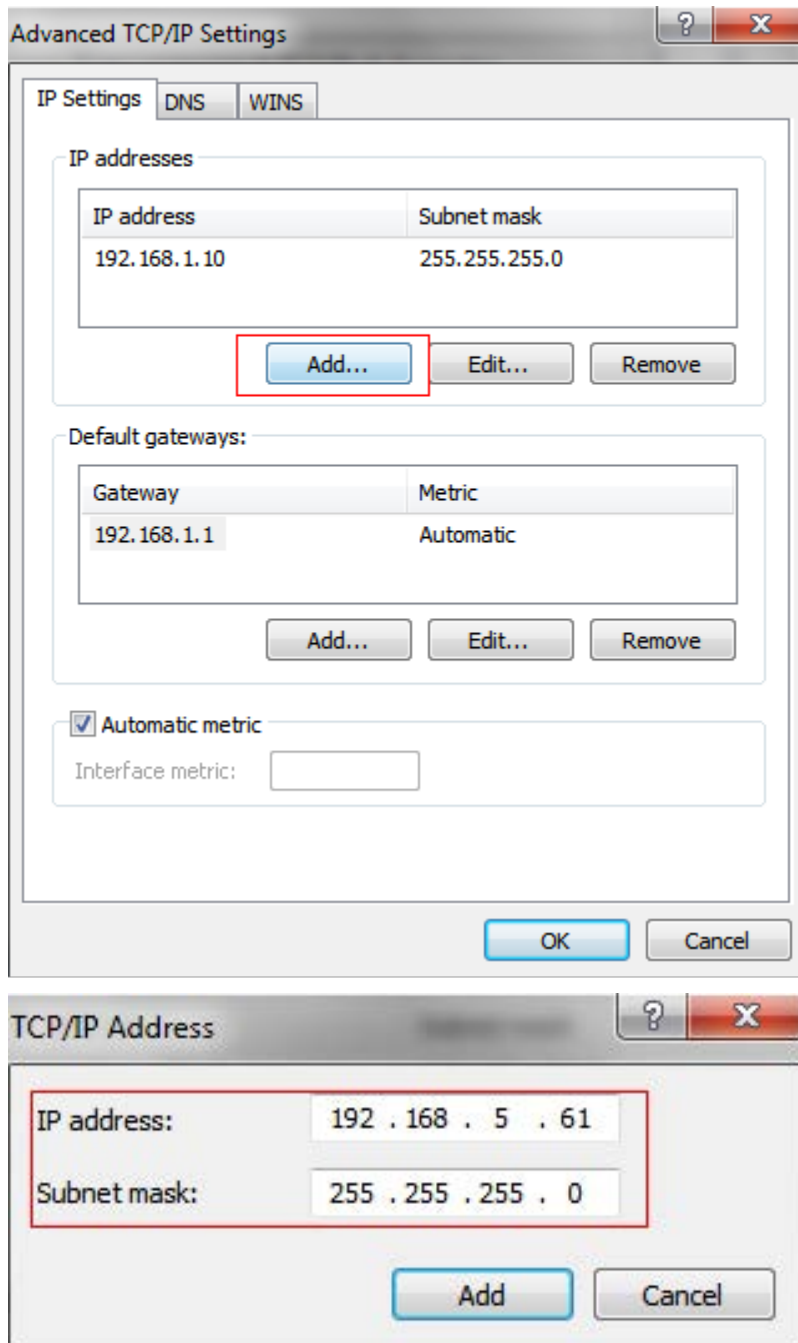

Step2: Start the browser. In the address bar, enter the default IP address of the camera: <http://192.168.5.190>;

Step3: You need to set the password first when using it for the first time. And you can also set three security questions for your device after activation. Then you can log in to the camera with the user name (admin) and a custom password.

 **Note:**

- Password must be 8 to 32 characters long, contain at least one number and one letter.
- You can click the “forget password” in login page to reset the password by answering three security questions when you forget the password, if you set the security questions in advance.

Step4: After login, please select “Settings” --> “Network” --> “Basic” --> “TCP/IP”. The Network Settings page appears (Shown as below Figure);

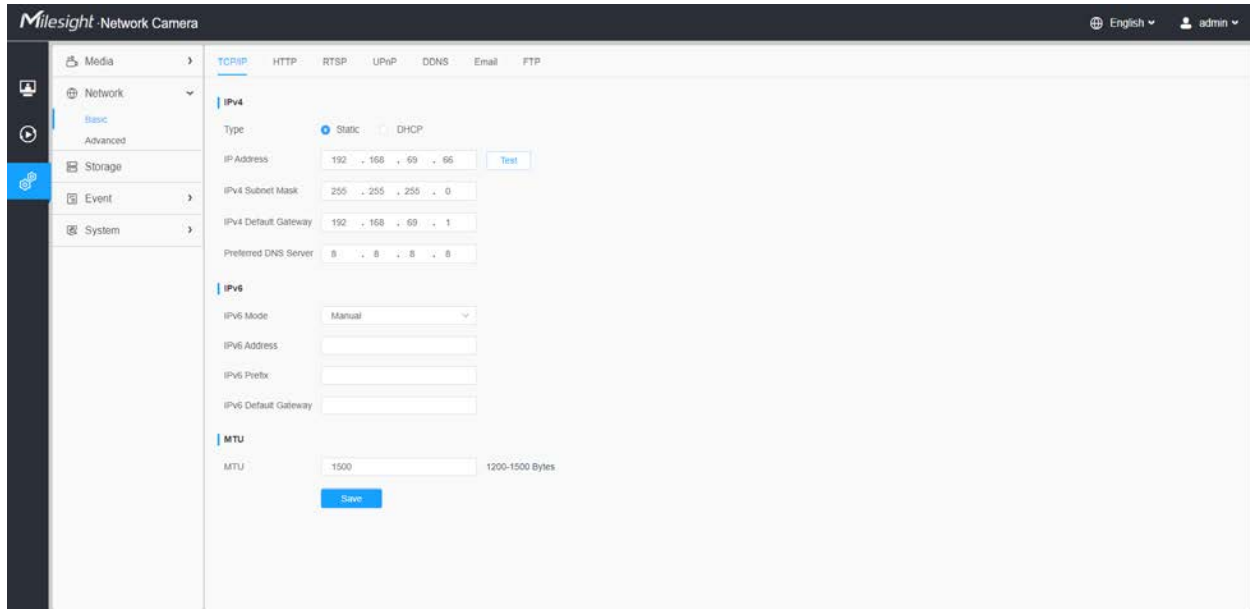

Step5: Change the IP address or other network values. Then click “Save” button;

Step6: The change of default IP address is completed.

Accessing from the Web Browser

The camera can be used with the most standard operating systems and browsers. And the camera was upgraded to support Plugin-Free Mode. In Plugin-Free Mode, you can preview the video on the browser without plugin. Currently Plugin-Free Mode is supported in Firefox & Google Chrome & Safari & Edge browser for Windows system, MAC system, iOS system and Android system. Both H.265&H.264 video codec are supported in Plugin-Free Mode for camera, and it will play the secondary stream by default.

Note:

- For more details about set plugin-free mode of MileSight camera, please refer to <https://milesight.freshdesk.com/a/solutions/articles/69000643388>.

4.5 Live View

Live Video

After logging in the network camera web GUI successfully, user is allowed to view live video as follows.

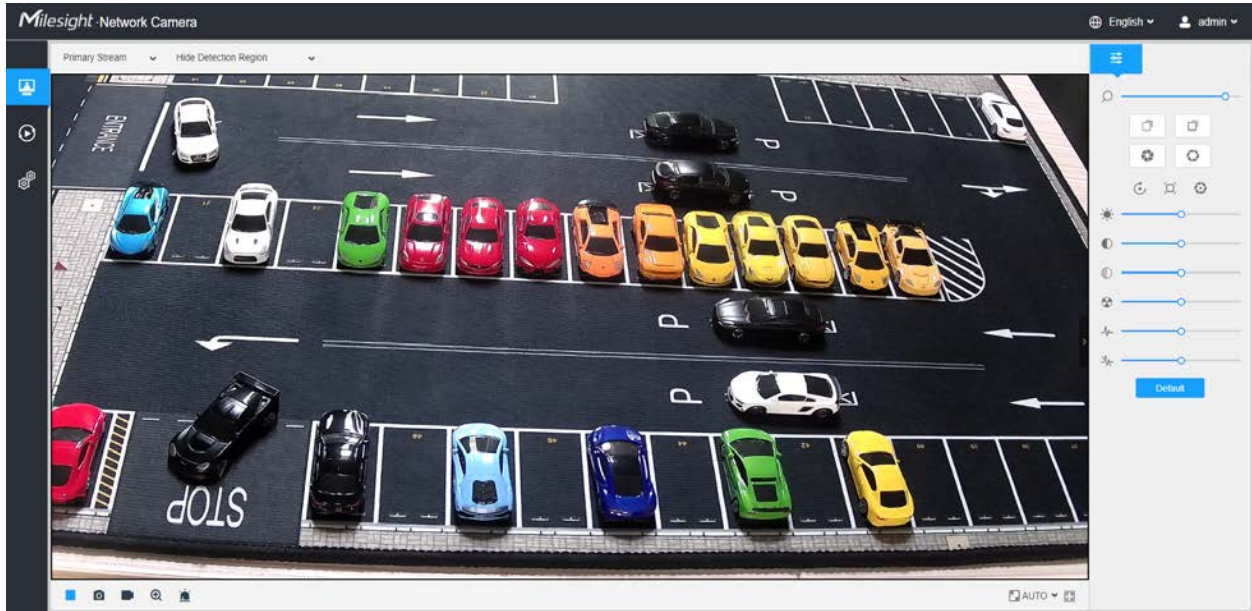



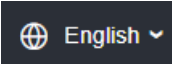
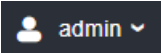
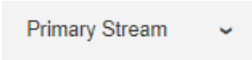









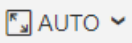

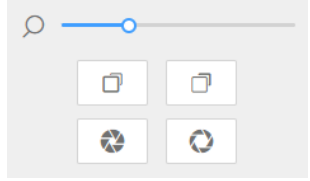









Table 155. Description of the buttons

No.	Parameter	Description
1	 Live Video	Click to access the live view page.
2	 Playback	Click to access the playback page.
3	 Settings	Click to access the configuration page.
4		Click to select system language.

No.	Parameter	Description
5		Display the user name and click to logout.
6		Choose the stream (Primary/Secondary/Tertiary) to show on the current video window.
7		<p>Choose the options (Hide Detection Region/Parking Space Detection) to hide/display detection region on the current video window.</p> 
8	 Recording	When recording, the icon appears.
9	 Alarm	When an alarm of Motion Detection was triggered, the icon appears.
10	 Alarm	Except for the kinds of alarms above, when other alarms were triggered, the icon appears.
11	 Stop/Play	Stop/Play live view.
12	 Snapshot	Click to capture the current image and save to the configured path. The default path is: C:\VMS\+-1\ IMAGE-MANUAL.
13	 Start/Stop Recording	Click to Start Recording video and save to the configured path. The default path is C:\VMS\+-1\MS_Record. Click again to Stop Recording .

No.	Parameter	Description
14	 Digital Zoom	When enabled, you can zoom in a specific area of video image with your mouse wheel.
15	 Manual Output	Manually trigger Camera Alarm Output.
16	 Window Size	Click to display images at a window size.
17	 Full Screen	Click to display images at full-screen.
		<p>Zoom: Adjust the Zoom length of the lens.</p> <p> Note: Only work when your camera is equipped with motorized lens.</p>
		<p>Focus-/Focus+: Adjust focus of the lens.</p> <p> Note: Only work when your camera is equipped with motorized lens.</p>
		<p>Lens Initialization, Auxiliary Focus and Auto Iris.</p> <p> Note:</p> <ul style="list-style-type: none"> The Auto Iris is turned on by default when your camera is equipped with auto focus lens. The Auto Iris support turn on/off when your camera is equipped with P-Iris.
		<p>Brightness: Adjust the Brightness of the scene.</p>
		<p>Contrast: Adjust the color and light contrast.</p>
		<p>Saturation: Adjust the Saturation of the image. Higher Saturation makes colors appear more "pure" while lower one appears more "wash-out".</p>
		<p>Sharpness: Adjust the Sharpness of image. Higher Sharpness sharps the pixel boundary and makes the image looks "more clear".</p>
		<p>2D DNR/3D DNR: Adjust the noise reduction level.</p>
<p>Default: Restore brightness, contrast and saturation to default settings.</p>		

4.6 Playback

Playback



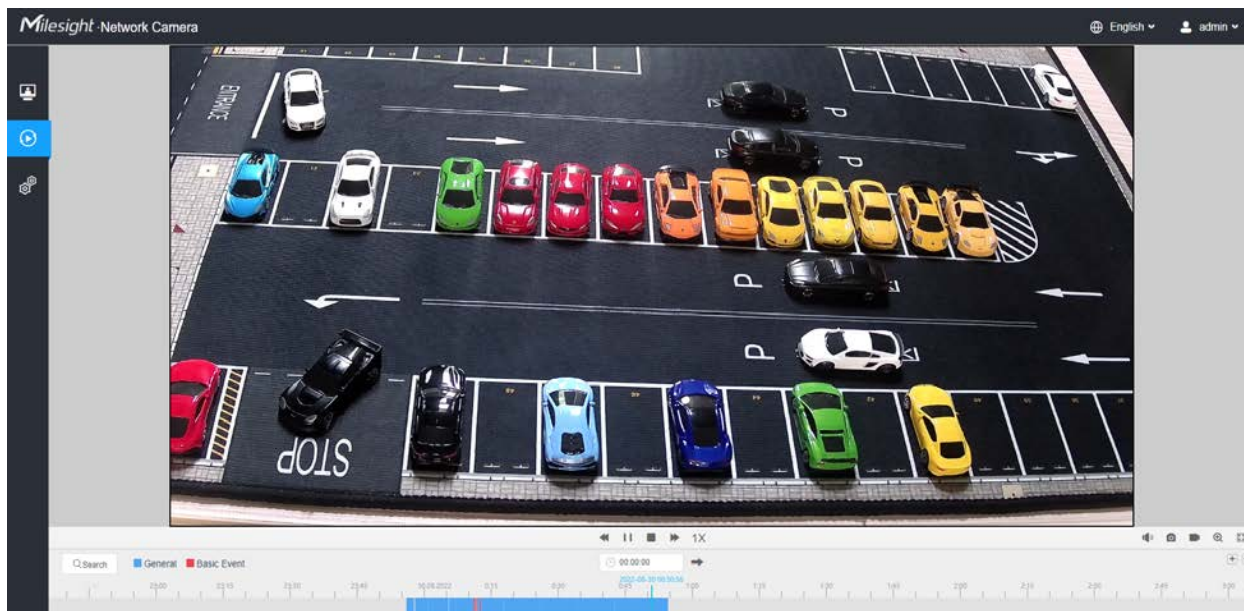

Click  to enter playback interface. In this part, you can search and playback the recorded video files stored in SD cards or NAS. The Playback interface is as below:

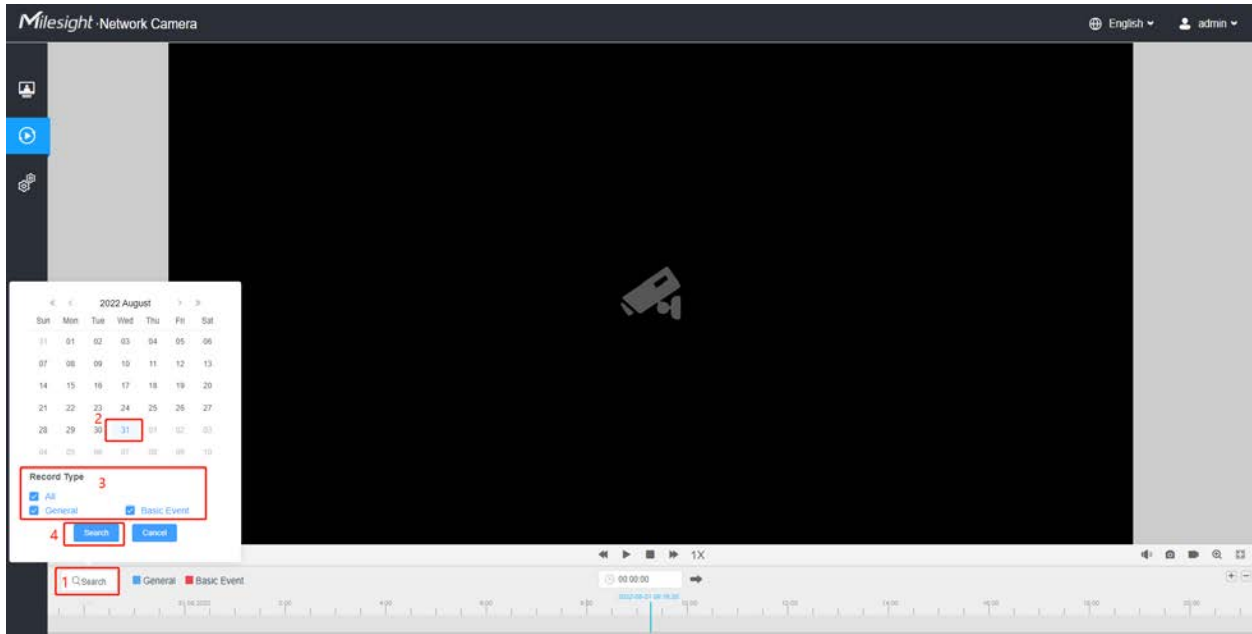

Step1: Click the “**Search**” botton, choose the data and record type when the window pops up.



Step2: The timeline displays the video files for the day and show different colors according to selected record type. Drag the progress bar with the mouse to locate the exact playback point as needed.

Note: You can also input the time and click  to locate the playback point in the  00:00:00 filed. You can also click   to zoom out/in the progress bar.

Step3: Click  to play the video files found on this date. The toolbar on the bottom of playback interface can be used to control playing progress.

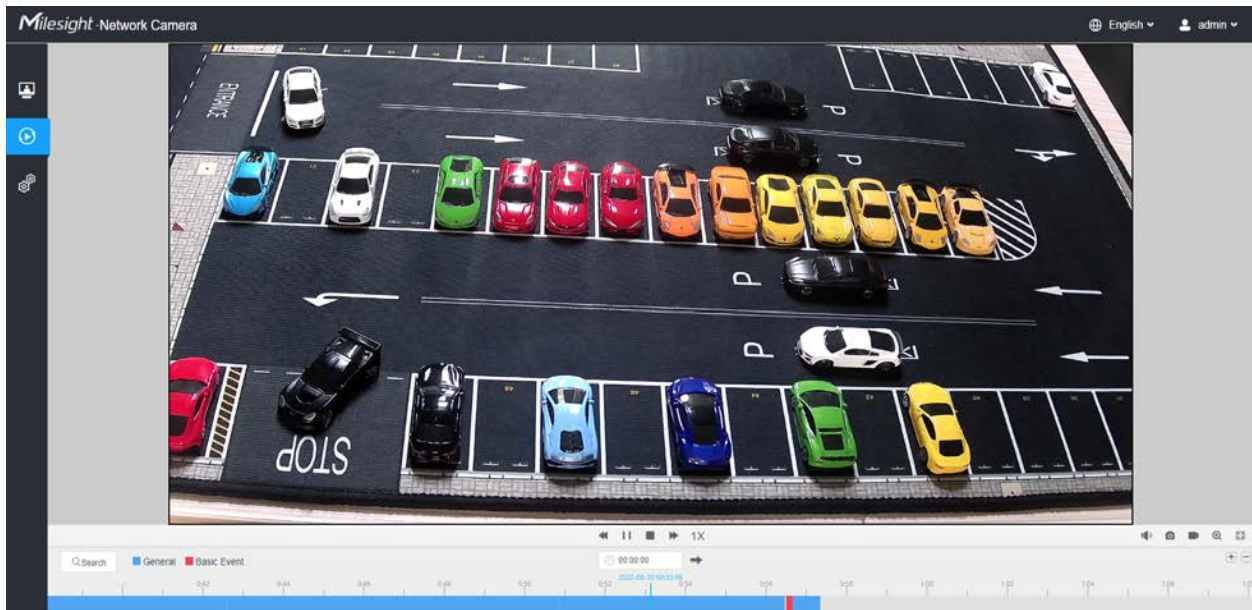

Table 156. Description of the buttons











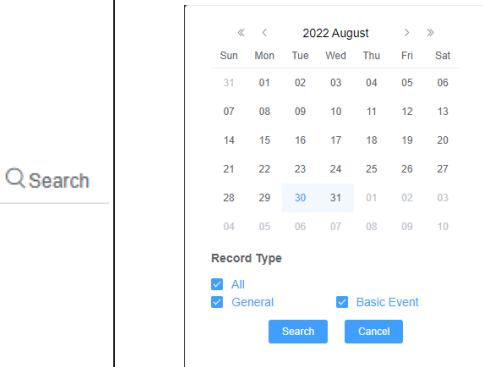

No.	Parameter	Description
		<p>Search the recorded videos by record type (All/General/Basic Event). The timeline will show different colors according to selected record type as below:</p> <div style="border: 1px solid #ccc; padding: 5px; width: fit-content; margin: 10px auto;"> ■ General ■ Basic Event </div>
1	 <p>Speed Down/Speed Up/Speed</p>	<p>Adjust the speed of video playback.</p> <p>Speed Down: Includes 0.5X and 0.25X for Play.</p> <p>Speed Up: Includes 2X and 4X for Play.</p> <p>Speed: The default playback speed is 1X</p>
2	 <p>Play/Pause</p>	<p>Play/Pause the video.</p>
3	 <p>Stop</p>	<p>Stop the video.</p>
4	 <p>Search Time</p>	<p>Select the time that want to locate.</p>
5	 <p>Jump</p>	<p>Go To.</p>

Table 157. Description of the buttons

No.	Parameter	Description
1	 <p>Mute</p>	<p>Click to enable the audio.</p>

No.	Parameter	Description
2	 Snapshot	Click to take a snapshot.
3	 Start/Stop recording	Click to start/stop recording.
4	 Digital Zoom	Click to zoom on/off .
5	 Full Screen	Full Screen.
6	 Time Expand/Narrow	Time narrow/expand.

4.7 Settings

4.7.1 Media

Video

Stream parameters can be set in this module, adapting to different network environments and demands.

Primary Stream Settings

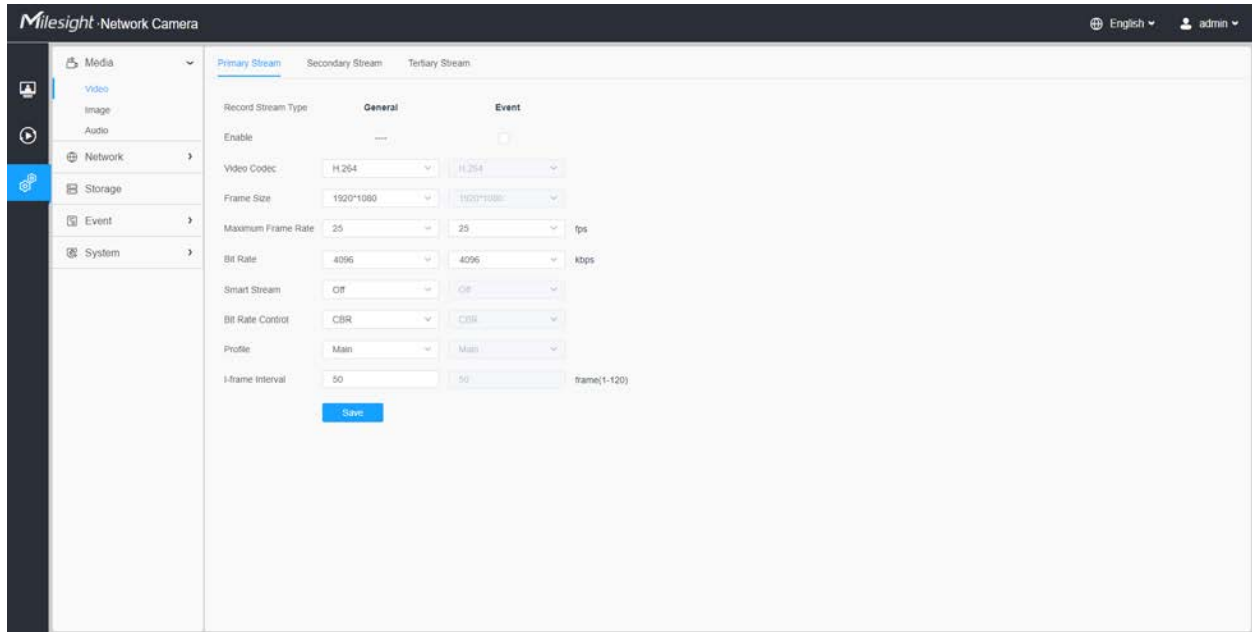

Secondary Stream Settings

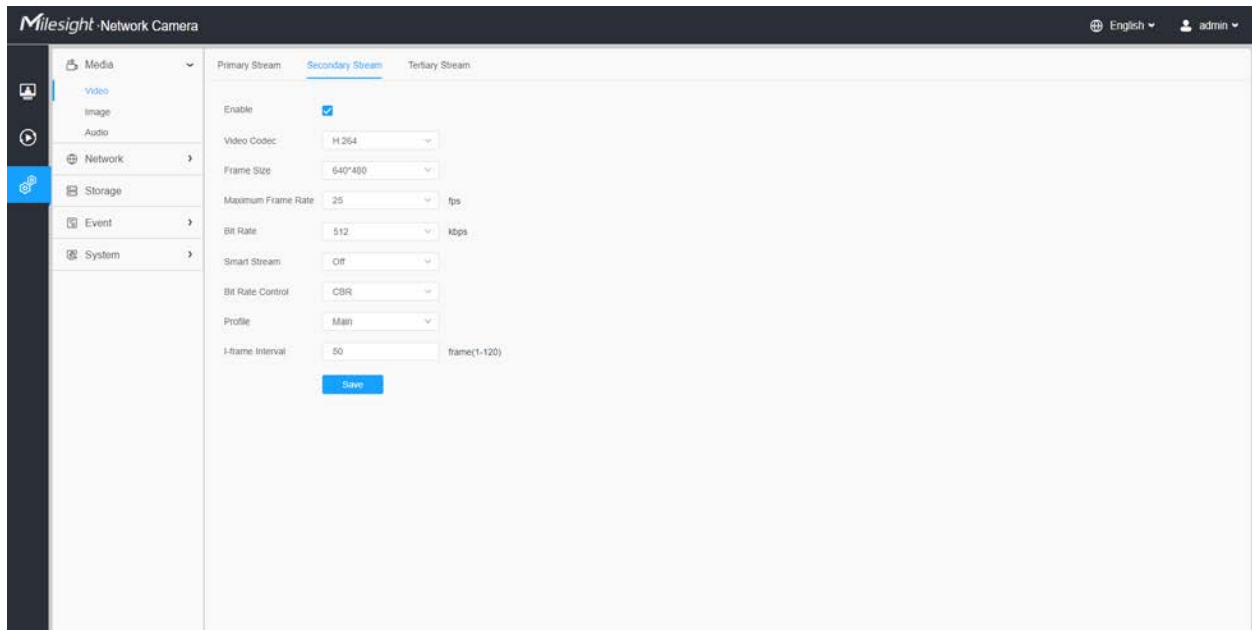

Tertiary Stream Settings

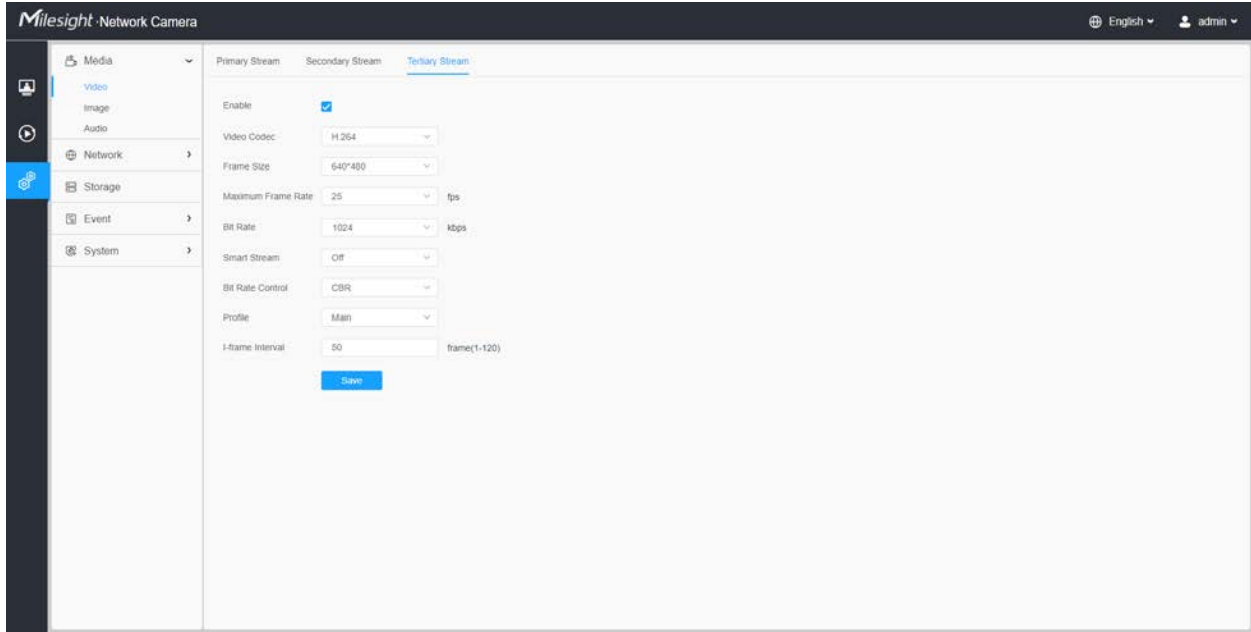



Table 158. Description of the buttons

Parameters	Function Introduction
<p>Record Stream Type</p>	<p>General & Event are available only for Primary Stream. General refers to continuous record video, while Event includes events that can trigger alarms, such as Motion, Exception, LPR and so on.</p> <p>This item can separately set different bit rate and frame rate for different Recording Stream Types. If user chooses Event, video will be recorded according to the configuration of video stream type when an event happens, thereby greatly reducing the recording storage space.</p>
<p>Enable Event Stream</p>	<p>This item is optional only if you selected the Event.</p>
<p>Video Codec</p>	<p>H.265/H.264/MJPEG are available.</p>
<p>Frame Size</p>	<p>Options include 8M(3840×2160), 6M(3072×2048), 5M(2592*1944), 5M(2560*1920), 5M(2560*1440), 4M(2592*1520), 3M(2304*1296), 3M(2048*1536), 1080P(1920*1080), 2M(1600 *1200), 1.3M(1280*960), 720P(1280*720), D1(704*576).</p> <p>For Secondary Stream, it includes 704*576, 640*480, 640*360, 352*288, 320*240, 320*192, 320*176.</p> <p>For Tertiary Stream, it include 1920*1080, 1280*720, 704*576, 640*480, 640*360, 352*288, 320*240, 320*192, 320*176.</p> <p> Note: The options of Frame Size are variable according to the model.</p>
<p>Maximum Frame Rate</p>	<p>Maximum refresh frame rate of per second and it is variable according to the mode.</p>

Parameters	Function Introduction
Bit Rate	Transmitting bits of data per second, this item is optional only if you select the H.265/H.264 Set the bitrate to 16~16384 Kbps. The higher value corresponds to the higher video quality, and the higher bandwidth is required as well.
Smart Stream	Optional to turn On/Off Smart Stream mode. Smart Stream mode remarkably reduces the bandwidth and the data storage requirements for network cameras while ensuring the high quality of images, and it is a 10-level adjustable codec. Level: Level 1~10 are available as needed.
Bit Rate Control	CBR: Constant Bitrate. The rate of CBR output is constant.
Bit Rate Control	VBR: Variable Bitrate. VBR files vary the amount of output data per time segment.
Image Quality	Low/Medium/High are available, this item is optional only if you select VBR.
Profile	The option is for H.264, Main/High/Base can be selected as needed.
I-frame Interval	Set the I-frame interval to 1~120, 50 for the default. This item is optional only if you select the H.265/H.264. The number must be a multiple of the number of frames.

Image

General settings of image including the image adjustment, day/night setting and image enhancement can be set in this module. OSD (On Screen Display) content, privacy mask and video time can be displayed to rich the image information.

General

General settings of image including the Image Adjustment, Day/Night Switch, Day/Night Parameters, Exposure, Backlight, White Balance, Image Enhancement and Display can be set in this module.

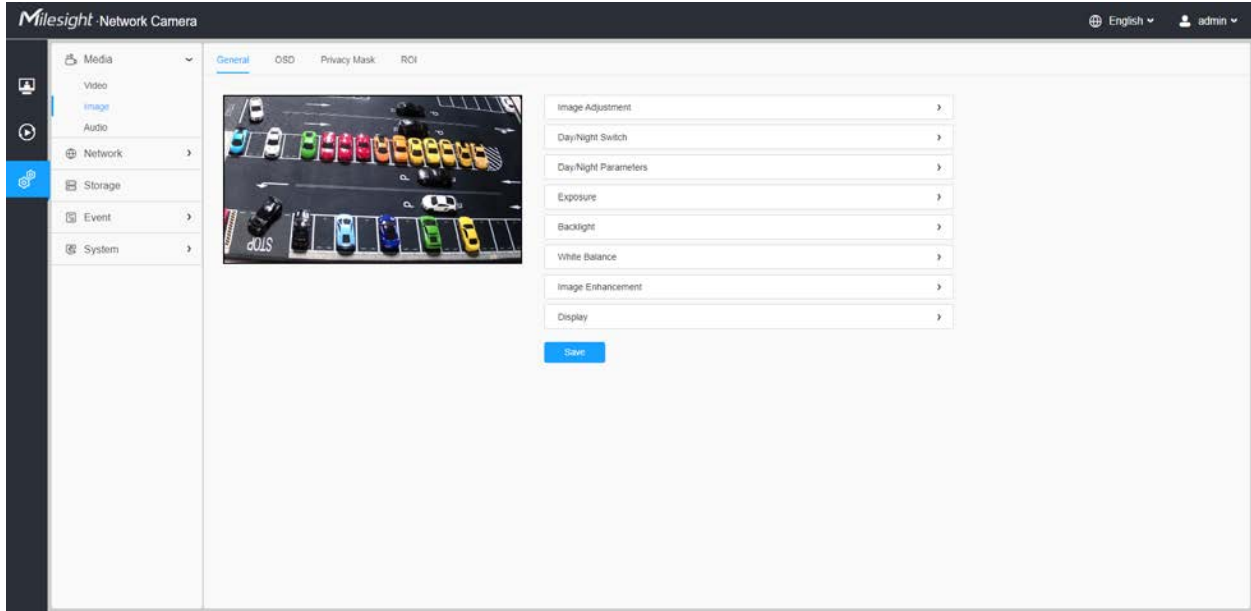

[Image Adjustment]

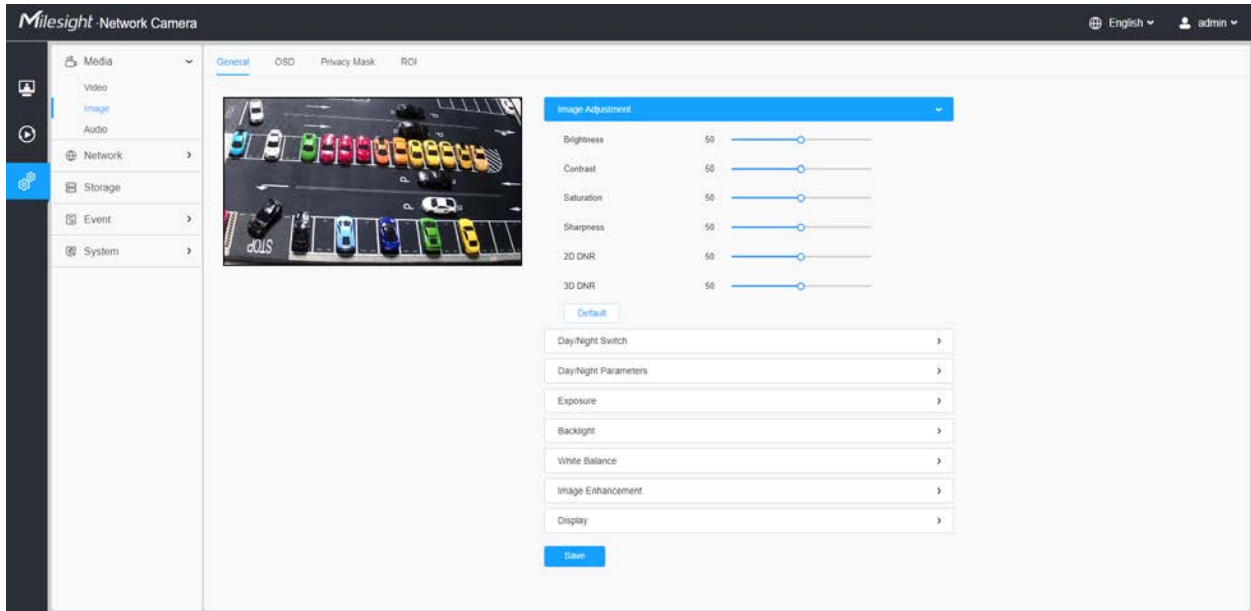
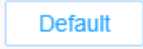

Table 159. Description of the buttons

Parameters	Function Introduction
Brightness	Adjust the Brightness of the scene.
Contrast	Adjust the color and light contrast.
Saturation	Adjust the Saturation of the image. Higher Saturation makes colors appear more "pure" while lower one appears more "wash-out".

Parameters	Function Introduction
Sharpness	Adjust the Sharpness of image. Higher Sharpness sharpens the pixel boundary and makes the image looks “more clear”.
2D DNR	Adjust the noise reduction level.
3D DNR	Restore brightness, contrast and saturation to default settings.
	Click this button to restore to the default setting.

[Day/Night Switch]

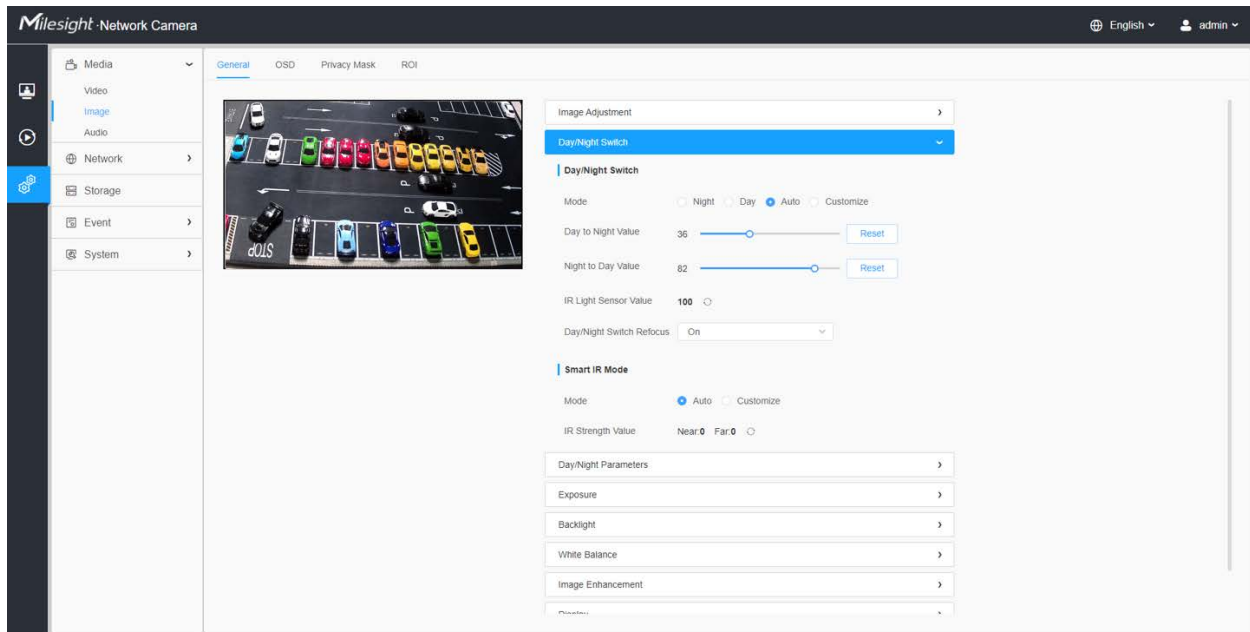

This option is used to control the Day/Night mode. And we applied **Smart IR II Technology** on the camera. It combines the High Beam and Low Beam, upgrading the IR LEDs technology to provide better image clarity and quality regardless of the object distance. Also, the Low Beam and High Beam's brightness can be adjusted manually or automatically on the basis of the Zoom ratio. Moreover, with the IR anti-reflection panel, the infrared light transmittance is highly increased.



There are 4 modes for Day/Night Switch, including Night, Day, Auto and Customize.

Table 160. Description of the options

Parameters	Function Introduction
Day/Night Switch	<p>Switch to Night Mode according to the parameters of night mode.</p> <p> Note: There are several parameters such as Exposure Level, Maximum Exposure Time and IR-CUT Interval, etc, associated with the mode.</p>

Parameters		Function Introduction
	Day	Switch to Day Mode according to the parameters of night mode.  Note: There are several parameters such as Exposure Level, Maximum Exposure Time and IR-CUT Interval, etc, associated with the mode.
	Auto	Select this option to automatically switch the Day/Night Mode based on the image. <ul style="list-style-type: none"> • Day to Night Value: You can set the sensitivity for switching Day Mode to Night Mode. When IR Light Sensor Current Value is lower than this value, it will switch Day Mode to Night Mode. You can click  to reset the value to 36. • Night to Day Value: This is the sensitivity for switching Night Mode to Day Mode. When IR Light Sensor Current Value is higher than this value, it will switch Night Mode to Day Mode. You can click  to reset the value to 82. • IR Light Sensor Value: The current value of the IR light sensor.
	Customize	Select this option to customize the Start Time and End Time of Night. <ul style="list-style-type: none"> • Start Time of Night: You can set the time for start the Night Mode. • End Time of Night: You can set the time for start the Day Mode.
	Day/Night Switch Refocus	With this option enabled, the camera will refocus when switching between day mode and night mode.

There are 2 modes for Smart IR Mode to achieve the best effect, including Auto and Customize.

Table 161. Description of the buttons

Parameters		Function Introduction
Smart IR Mode	Auto	Select this option to automatically adjust the strength of the Low-Beams LED, High-Beams LED on the basis of the Zoom ratio.
	Customize	Select this option to manually adjust the strength of the Low-Beams LED, High-Beams LED. You can click  to reset the light strength. <ul style="list-style-type: none"> • Near View IR Level: Adjust the light strength of Low-Beams LED light level from 0 to 100. • Far View IR Level: Adjust the light strength of High-Beams LED light level from 0 to 100. • IR Strength Value: Show the current value of Low-Beams LED, High-Beams LED.

[Day/Night Parameters]

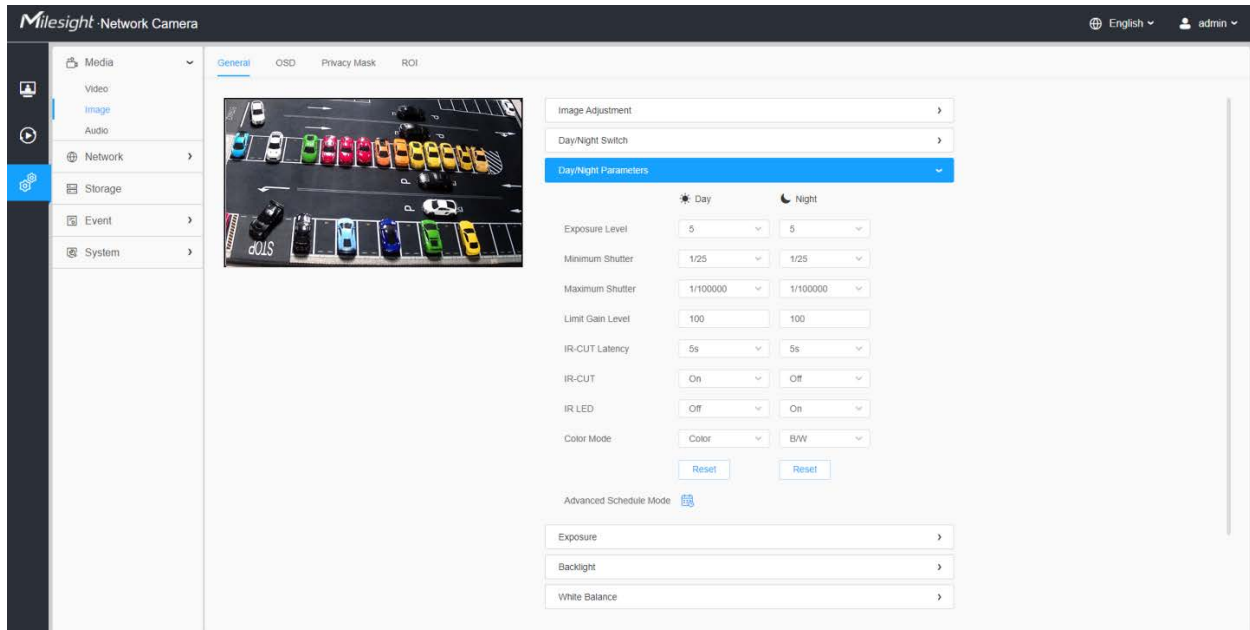

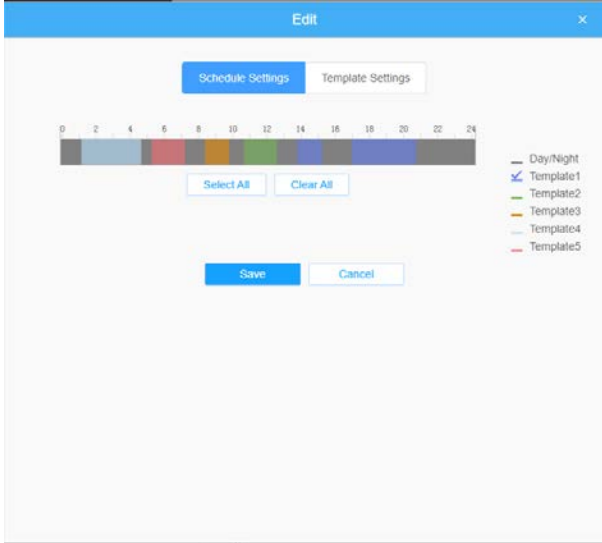

Table 162. Description of the buttons

Parameters	Function Introduction
Exposure Level	Level 0~10 are available to meet your need.
Minimum Shutter	Minimum Shutter is the same as Maximum Exposure Time. Set the minimum Shutter to 1~1/100000s.
Maximum Shutter	Maximum Shutter is the same as Minimum Exposure Time. Set the maximum Shutter to 1~1/100000s.
IR-CUT Latency	The interval time of switching one mode to another.
Limit Gain Level	Set the Limit Gain Level to 1~100.
IR-CUT	Turn on/off IR-CUT.
IR LED	Turn on/off IR-LED.
Color Mode	Select B/W or Color mode.

Parameters	Function Introduction
<div style="text-align: center;">  <p>Advanced Schedule Mode</p> </div>	<p>Here you can customize your special demands for different time, then the Day mode and Night mode will switch automatically according to your settings.</p> 

[Exposure]

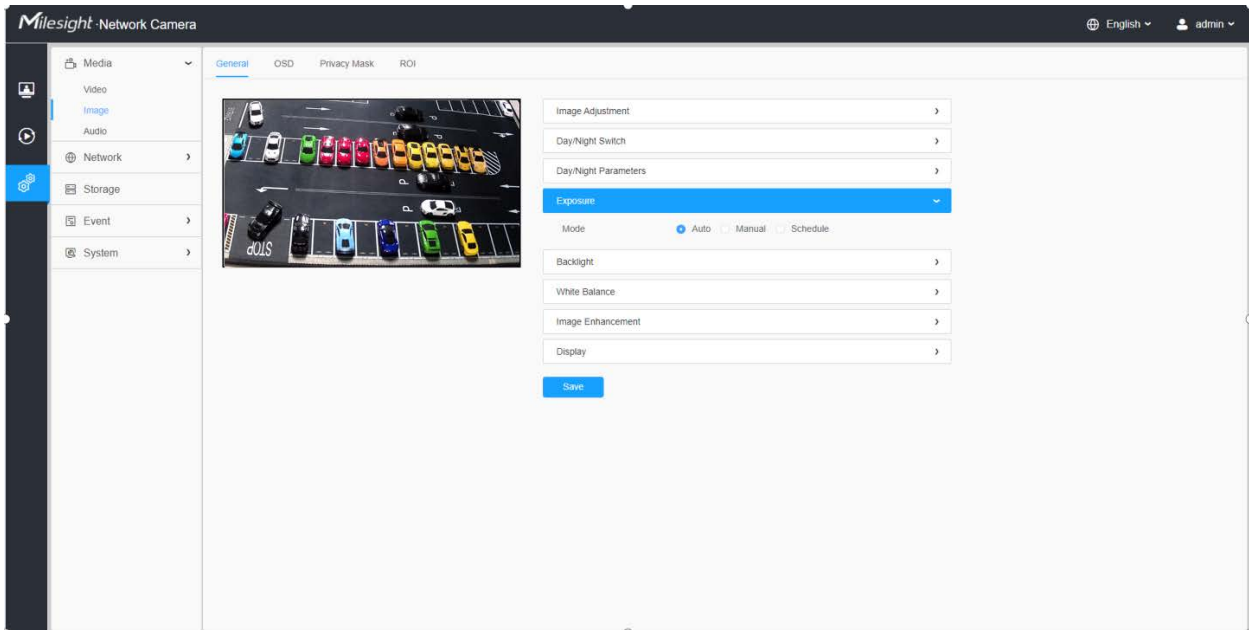
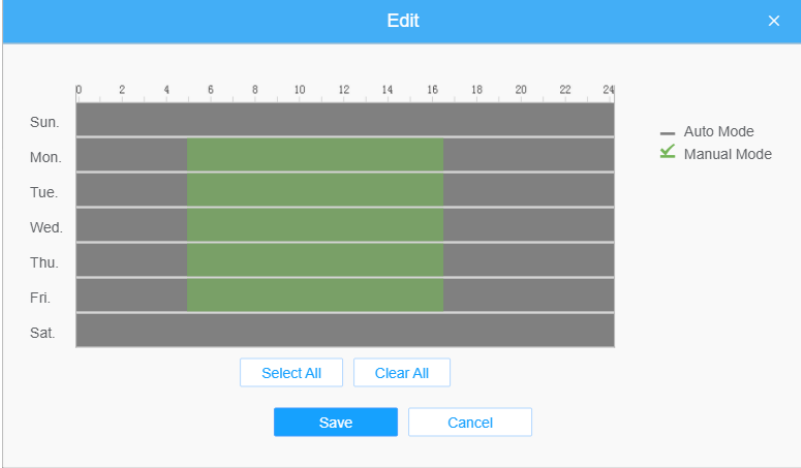

Table 163. Description of the buttons

Parameters	Function Introduction
<p style="text-align: center;">Exposure Mode</p>	<p>Auto Mode, Manual Mode and Schedule Mode are available.</p> <p>Auto Mode: The camera will adjust the brightness according to the light environment automatically.</p> <p>Manual Mode: The camera will adjust the brightness according to the value you set, you can set the exposure time from 1~1/100000s, the higher the value is, the brighter the image is.</p> <p>Schedule Mode: You can customize the schedule to enable/disable Auto Mode and Manual Mode.</p> 

[Backlight]

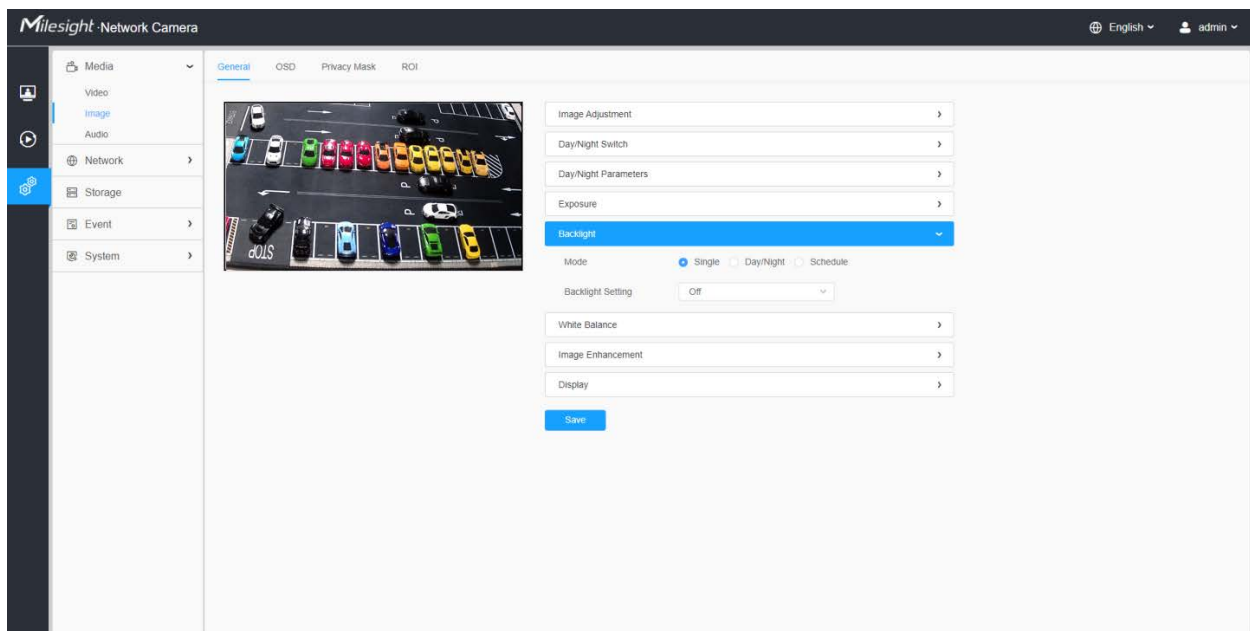

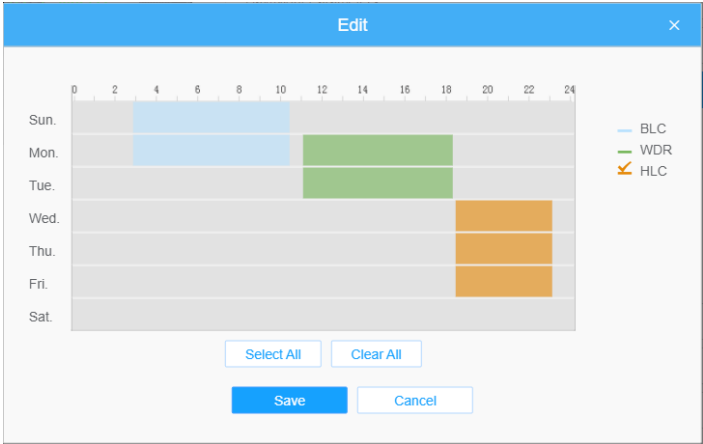

Table 164. Description of the buttons

Parameters	Function Introduction
<p style="text-align: center;">Backlight Mode</p>	<p>Single Mode: Set single mode for BLC/WDR/HLC.</p> <p> Note: Do not support WDR and General HLC while High Frame Rate is enabled.</p> <p>Day/Night Mode: Support BLC/WDR/HLC on Day Enhancement Mode/Night Enhancement Mode separately.</p> <p>Schedule Mode: Set schedule mode for BLC/WDR/HLC. You can customize the schedule to enable/disable BLC/WDR/HLC mode.</p> 

 **Note:**

- For more details about **Milesight WDR on & off Video**, you can click to the YouTube:
<https://www.youtube.com/watch?v=McoOL0Pyk0w>
- For more details about **Milesight Ultra Low-light Video Demo - HLC**, you can click to the YouTube:
<https://www.youtube.com/watch?v=ly8uKWbii40>
- For more details about **Milesight Super WDR Pro**, you can click to the YouTube:
<https://www.youtube.com/watch?v=edsPZXBjRnl>
- For more details about **Milesight Super WDR Performance**, you can click to the YouTube:
<https://www.youtube.com/watch?v=BKEZ6BW-YZE>

[White Balance]

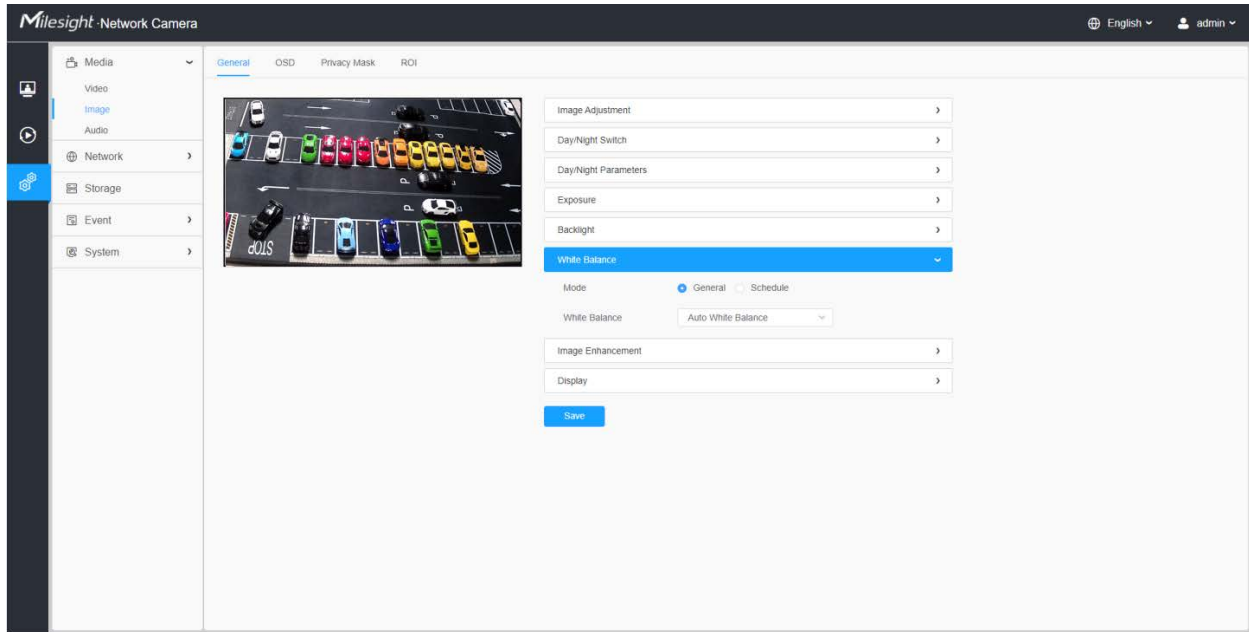
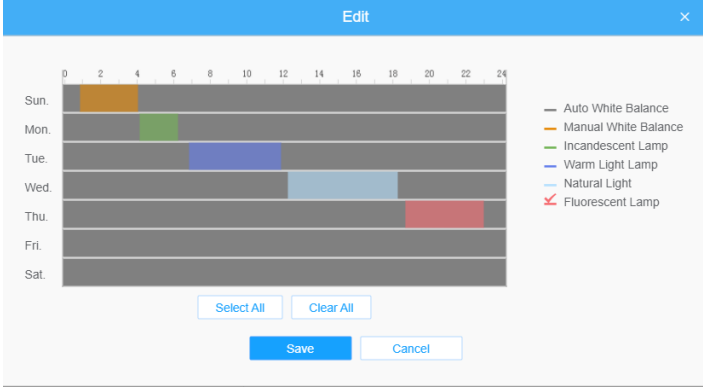

Table 165. Description of the buttons

Parameters	Function Introduction
<p>White Balance</p>	<p>To restore white objects, removed color distortion caused by the light of the environment.</p> <p>Mode: General and Schedule are available.</p> <hr/> <p>General Mode: Select a white balance mode as required</p> <ul style="list-style-type: none"> • Auto White Balance: This option will automatically enable the White Balance function. • Manual White Balance: Set Red Gain Level and Blue Gain Level manually. • Incandescent Lamp: Select this option when light is similar with incandescent lamp. • Warm Light Lamp: Select this option when light is similar with warm light lamp. • Natural Light: Select this option when there is no other light but natural light. • Fluorescent Lamp: Select this option when light is similar with Fluorescent Lamp.

Parameters	Function Introduction
	<p>Schedule Mode: Select this option that you can customize the schedule to enable/ disable above modes.</p> 

[Image Enhancement]

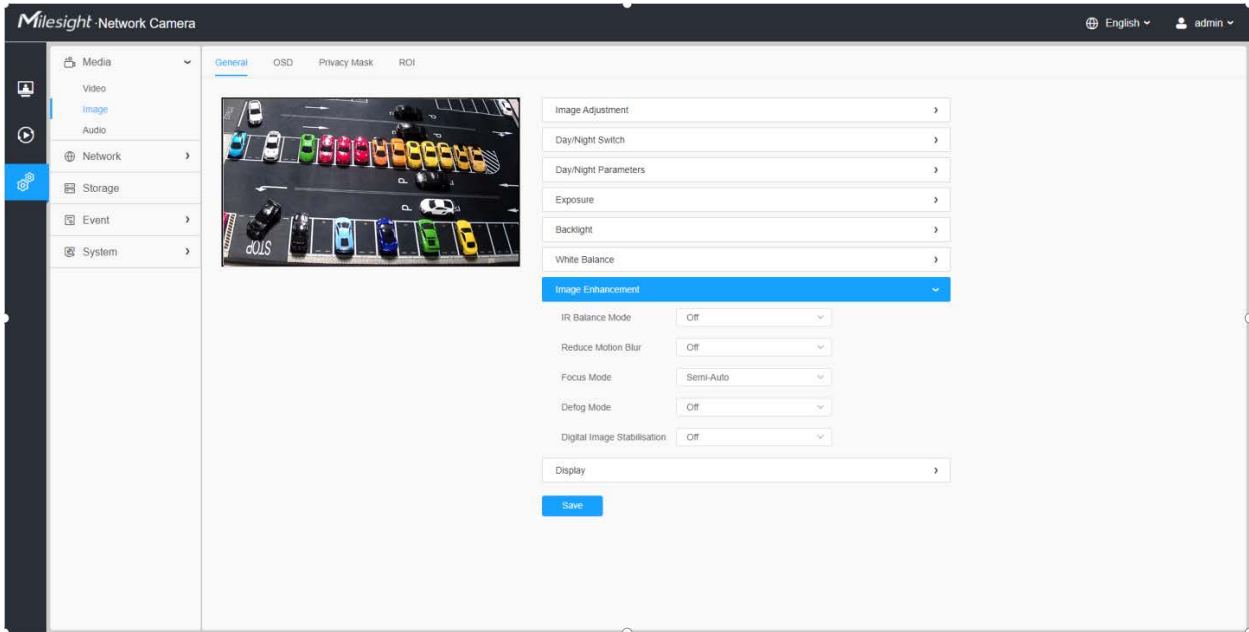



Table 166. Description of the buttons

Parameters	Function Introduction
<p>IR Balance Mode</p>	<p>There is an option to turn On/Off the IR LED.</p> <p>IR Balance Mode would avoid the problem of overexposure and darkness, and the IR LED will change according to the actual illumination.</p>

Parameters	Function Introduction
Reduce Motion Blur	<p>Enable this function to reduce the motion blur of objects effectively.</p> <p>You can adjust the deblur level from 1 to 100.</p> <p> Note: For more details about Milesight Deblur, you can click to the YouTube: https://www.youtube.com/watch?v=-vynrami51s</p>
Defog Mode	<p>Better image effect in foggy weather.</p> <p> Note:</p> <ul style="list-style-type: none"> For more details about Milesight Defog, you can click to the YouTube: https://www.youtube.com/watch?v=a9od7Trao4U
Digital Image Stabilisation	Decrease the blur and shakiness of the image.

[Display]

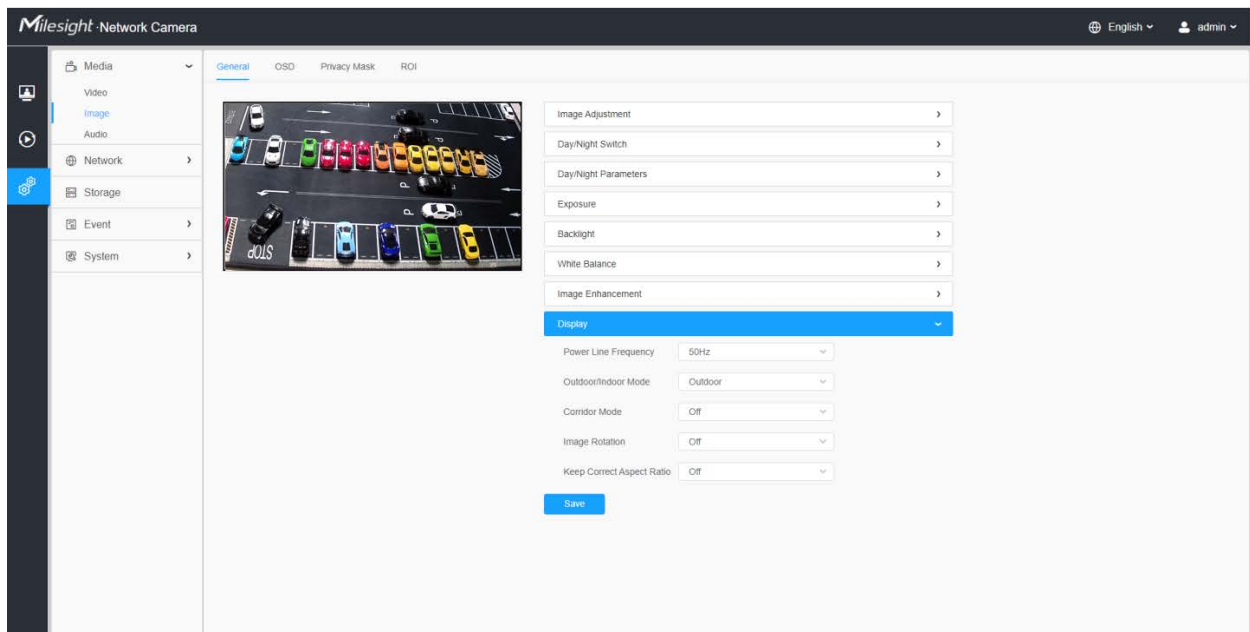

Table 167. Description of the buttons

Parameters	Function Introduction
Power Line Frequency	60Hz and 50Hz are available.
Outdoor/Indoor Mode	Select indoor or outdoor mode to meet your needs.

Parameters	Function Introduction
Corridor Mode	<p>There are three options available, you can select one to meet your need.</p> <p>Off: Keep the image in normal direction.</p> <p>Clockwise 90°: Rotate the image by 90° clockwise.</p> <p>Anticlockwise90°: Rotate the image by 90° anticlockwise.</p>
Image Rotation	<p>There are four options available, you can select one to meet your need.</p> <p>Off: Keep the image in normal direction.</p> <p>Rotating 180°: Upside down the image.</p> <p>Flip Horizontal: Flip the image horizontally.</p> <p>Flip vertical: Flip the image vertically.</p>
Keep Correct Aspect Ratio	<p>With this option enabled, the camera will prevent the image from distortion when resolution ratio is changed.</p>

OSD

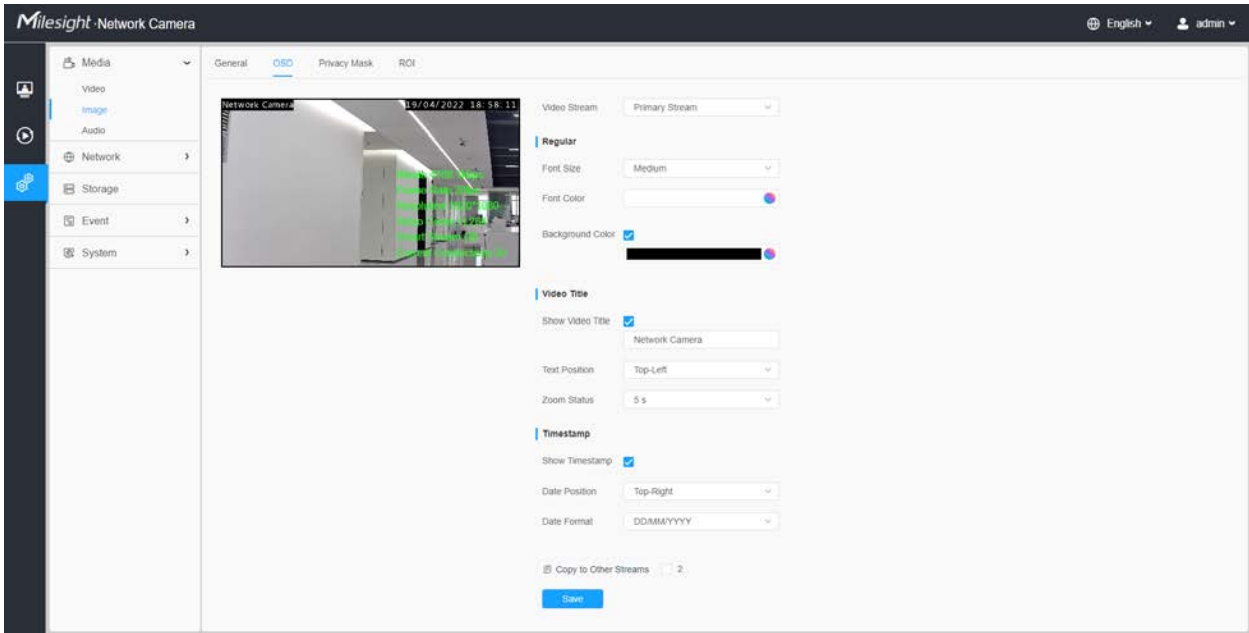
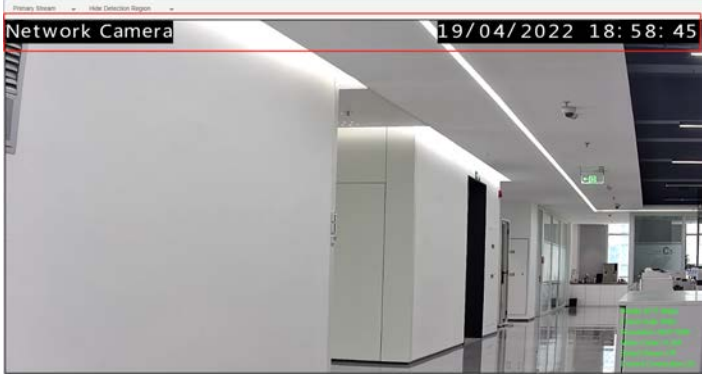

Table 168. Description of the buttons

Parameters	Function Introduction
Video Stream	Enable to set OSD for primary stream and secondary stream.
Font Size	Smallest/Small/Medium/Large/Largest/Auto are available for title and date.
Font Color	Enable to set different color for title and date.

Parameters	Function Introduction
Background Color	<p>Enable to set different colors for display information background on screen.</p> <p>You can set different colors for font and background of image , then the image OSD will show as below:</p> 
Show Video Title	Check the check box to show video title.
Video Title	Customize the OSD content.
Text Position	OSD display position on the image.
Show Timestamp	Check the checkbox to display date on the image.
Date Position	Date display position on the image.
Date Format	The format of date.
Copy to Other Streams	Copy the settings to other streams.

Privacy Mask

Privacy mask enables to cover certain areas on the live video to prevent certain spots in the surveillance area from being viewed and recorded.

You can select the color type and mosaic type to use for the cover certain areas on the live video. The mosaic type can maintain the continuity of the picture and improve the visual effect. Up to 28 mask areas are supported, which includes 24 mask areas and 4 mosaic areas.

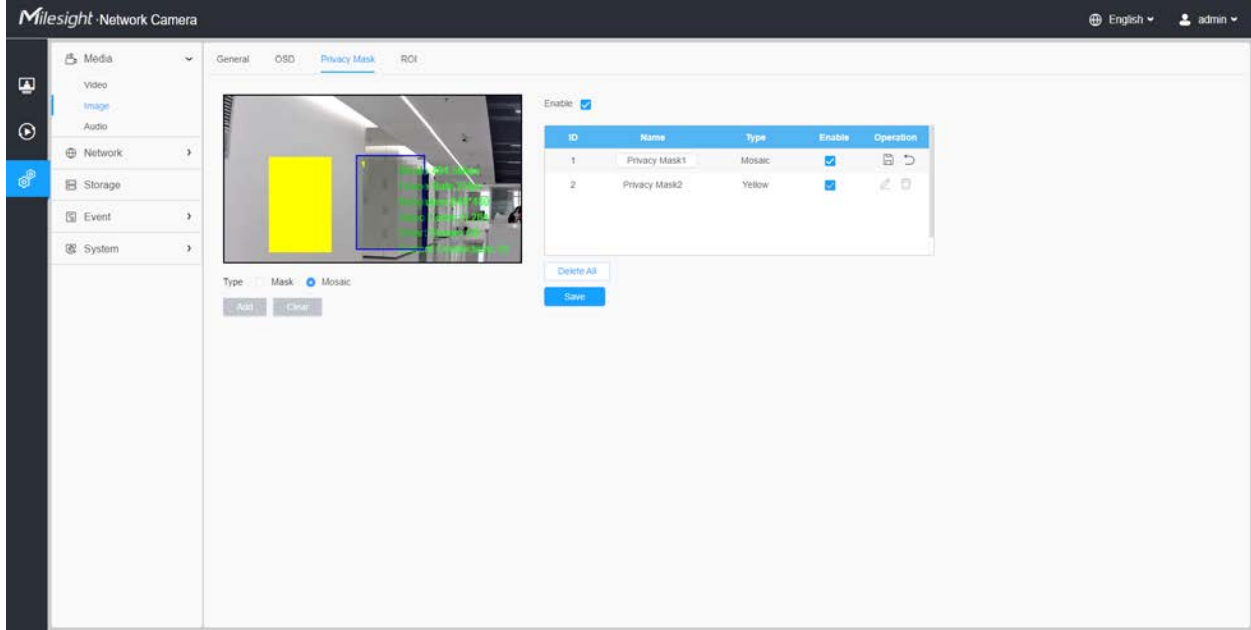
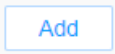







Table 169. Description of the buttons

Parameters	Function Introduction	
Enable	Check the check box to enable the Privacy Mask function.	
Type	Select the type to use for the privacy areas, there are two types available: Mask and Mosaic.	
	Drew an privacy area on the live video as needed.	
	Clear the area you drew on the live video.	
Operation		Enable/disable the selected ROI areas.
		Change the color of Mask area, there are eight colors available: White, Black, Blue, Yellow, Green, Brown, Red and Purple
		Delete the privacy mask area

ROI

Region of interest (often abbreviate ROI), is a selected subset of samples within a dataset identified for a particular purpose. Users can select up to 8 key regions of a scene to transmit through separate streams for targeted preview and recording.

By using Milesight ROI technology, more than 50% of bit rate can be saved and therefore less bandwidth demanded and the storage usage reduced. So according to this, you can set a small bit rate for high resolution.

 **Note:** For more details about how to set ROI, please refer to <https://milesight.freshdesk.com/a/solutions/articles/69000643441>.

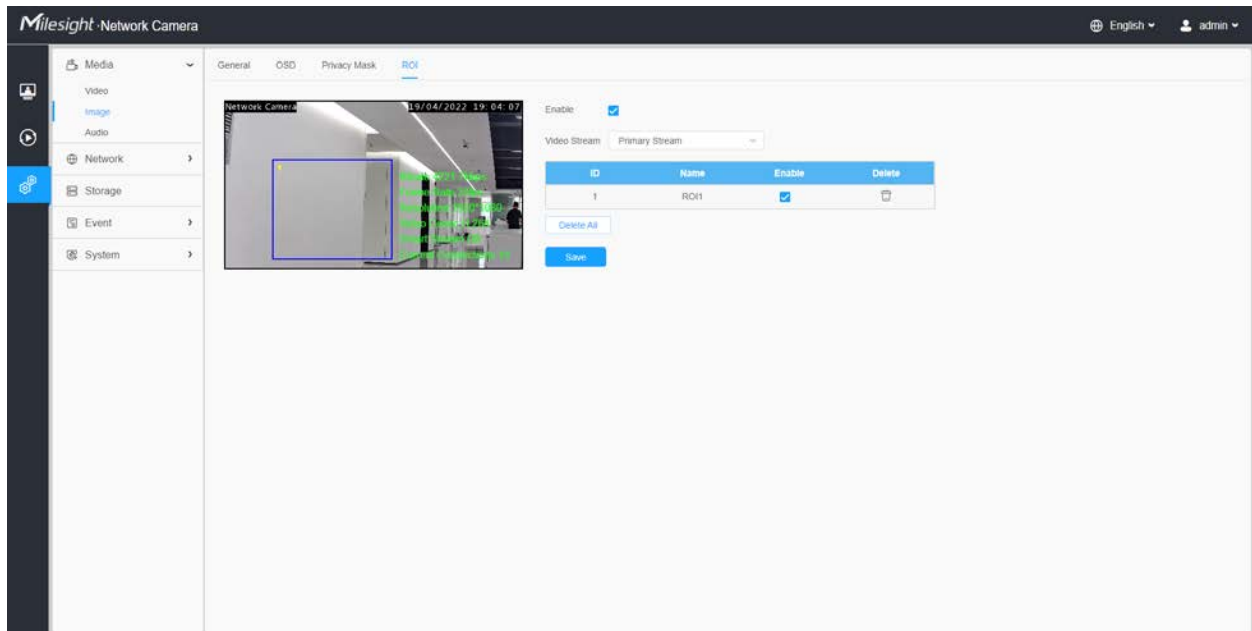



Table 170. Description of the buttons

Parameters	Function Introduction	
Enable	Check the checkbox to enable the ROI function.	
Video Stream	Choose the Video Stream.	
ROI	<input type="checkbox"/> / <input checked="" type="checkbox"/>	Enable/disable the selected ROI areas.
		Delete the selected ROI areas.
Delete All	Clear all areas you drew before.	

 **Note:**

- You can set a low bit rate. For example, you can set a bit rate with 512Kbps and a resolution with 1080P, then you can see the image quality of ROI is more clear and fluent than the other region.

Audio

Audio

This audio function allows you to hear the sound from the camera or transmit your sound to the camera side. A two-way communication is also possible to be achieved with this feature. Alarm can be triggered when the audio input is above a certain alarm level you set, and configured audio can be played when an alarm occurs.

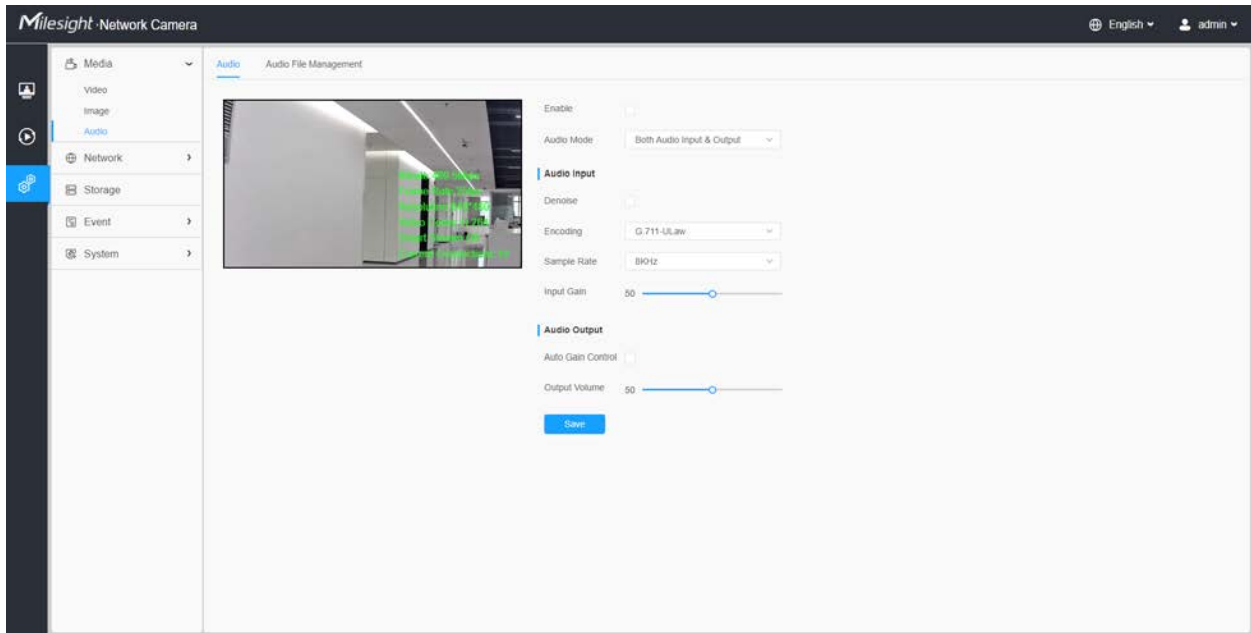

Table 171. Description of the buttons

Parameters	Function Introduction
Enable	Check on the checkbox to enable audio feature.
Audio Mode	Audio Input/Audio Output/Both Audio Input & Output are optional.

Parameters	Function Introduction
Audio Input	<p>Denoise: Set it as On/Off. When you set the function on, the noise detected can be filtered.</p> <p>Encoding: G.711-ULaw, G.711-ALaw, AAC LC, G.722 and G.726 are available</p> <p>Audio Bit Rate: The function is available only for AAC LC, and supports up to 48kbps.</p> <p>Sample Rate: 8KHz, 16KHz, 32KHz, 44.1KHz, and 48KHz are available.</p> <p>Input Gain: Input audio gain level, 0-100.</p> <p>Alarm Level: Alarm will be triggered if voice alarm is enabled and input gained volume is higher than the alarm level, 1-100.</p>
Audio Output	<p>Auto Gain Control: This function is only for H.265 series, improve the quality of audio</p> <p>Output Volume: Adjust volume of output</p>

Auto File Management

You can upload up to 5 audio files manually to Flash or SD Card on the Audio web page and you can also edit the audio file's name when upload.

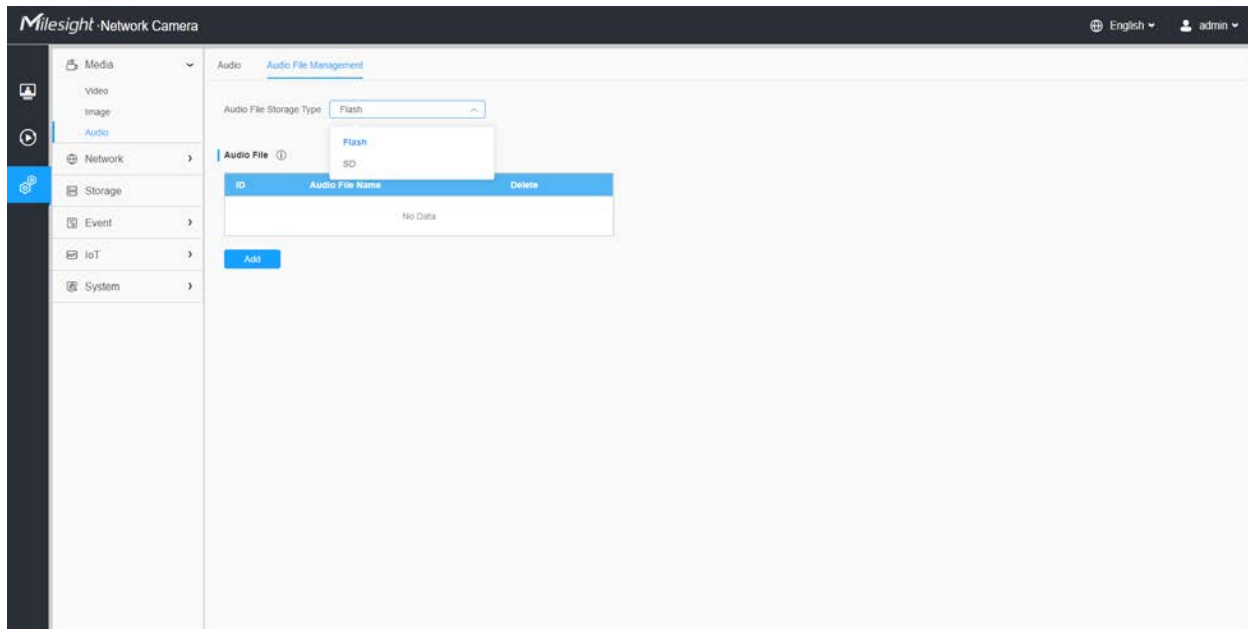

Note:

- The Audio mode and Audio Output are only for certain modules.
- Only support '.wav' audio files with codec type PCM/PCMU/PCMA, 64kbps or 128 kbps and no more than 500k.

4.7.2 Network

Basic

TCP/IP

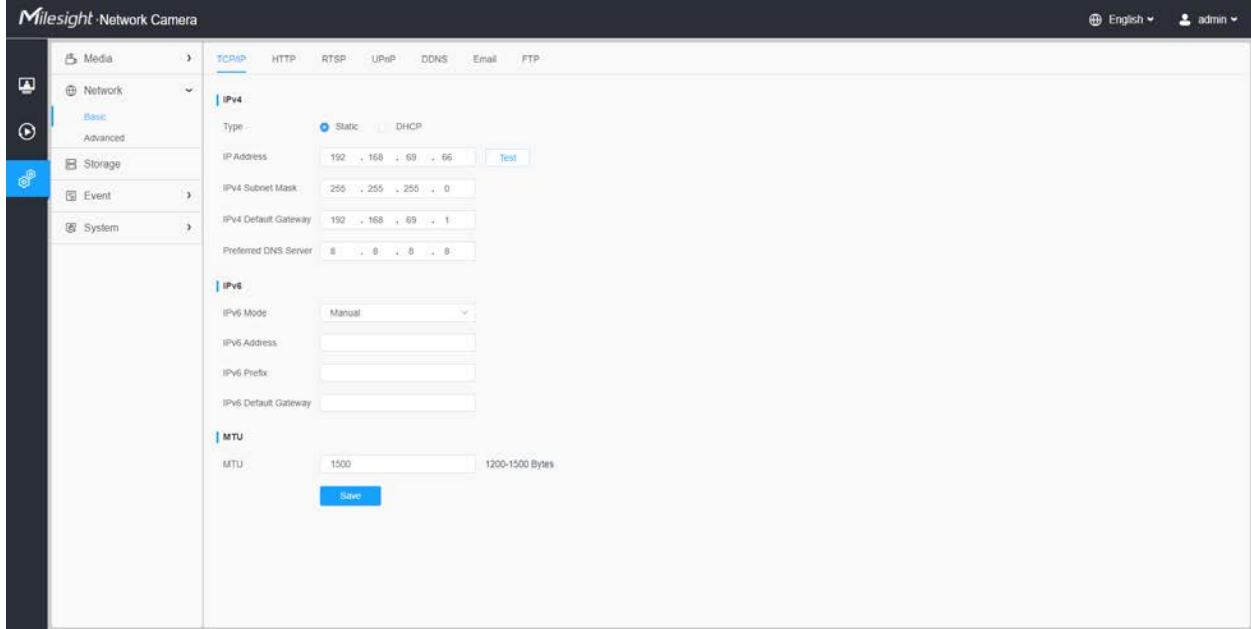



Table 172. Description of the buttons

Parameters	Function Introduction
IPv4	<p>Type: Static Type and DHCP Type are optional for user to get IPv4 address automatically or use fixed IP address.</p> <p>IPv4 Address: An address that used to identify a network camera on the network.</p> <p> Note: The Test button is used to test if the IP is conflicting.</p> <p>IPv4 Subnet Mask: It is used to identify the subnet where the network camera is located.</p> <p>IPv4 Default Gateway: The default router address.</p> <p>Preferred DNS Server: The DNS Server translates the domain name to IP address.</p>

Parameters	Function Introduction
<p>IPv6</p>	<p>IPv6 Mode: Choose different modes for IPv6: Manual/Route Advertisement/DHCPv6</p> <p>IPv6 Address: IPv6 Address used to identify a network camera on the network</p> <p>IPv6 Prefix: Define the prefix length of IPv6 address</p> <p>IPv6 Default Gateway: The default router IPv6 address</p>
<p>MTU</p>	<p>Maximum Transmission Unit. The default value is 1500. You can customize the value from 1200 to 1500 as needed.</p>
<p>Save</p>	<p>Save the configuration.</p>

HTTP

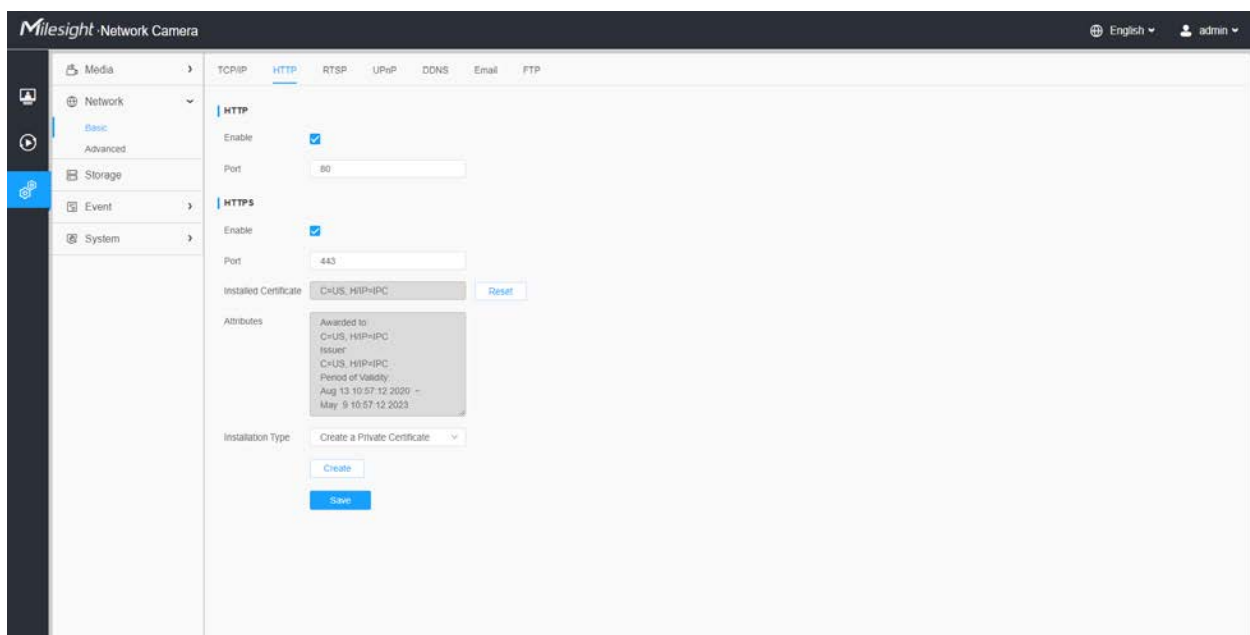

Table 173. Description of the buttons

Parameters	Function Introduction
<p>HTTP</p>	<p>Enable: Start or stop using HTTP.</p> <p>Port: Web GUI login port, the default is 80, the same with ONVIF port.</p>



Parameters	Function Introduction
HTTPS	<p>Enable: Start or stop using HTTPS.</p> <p>Port: Web GUI login port via HTTPS, the default is 443.</p> <p> Note: For more details about how to use enable HTTPS access, please refer to https://milesight.freshdesk.com/a/solutions/articles/69000797384.</p>
Installed Certificate	Upload and set the SSL certificate.
Attributes	
Installation Type	
	Save the configuration.

Table 174. HTTP URL are as below:

Stream	URL
Main Stream	http://username:password@IP:port/ipcam/mjpeg.cgi
Secondary Stream	http://username:password@IP:port/ipcam/mjpegcif.cgi
Tertiary Stream	http://username:password@IP:port/ipcam/mjpegthird.cgi

RTSP

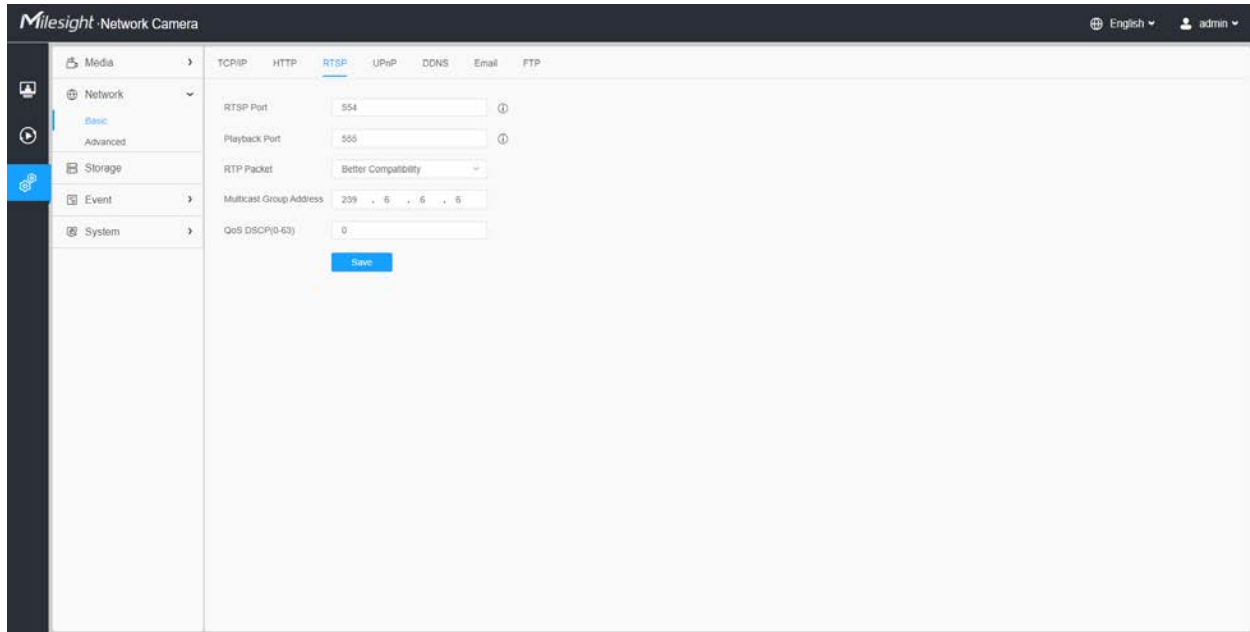

Table 175. Description of the buttons



Parameters	Function Introduction
RTSP Port	The port of RTSP, the default is 554.
Playback Port	Playback Port The port of playback, the default is 555.  Note: Port 0 means closing playback function.
RTP Packet	There are Better Compatibility and Better Performance two options, if your camera's image mess up, please switch this option.
Multicast Group Address	Support multicast function.
QoS DSCP	The valid value range of the DSCP is 0-63.
	Save the configuration.

Table 176. RTSP URL are as below:

Stream	URL
Primary Stream	rtsp://IP:RTSP Port/main
Secondary Stream	rtsp://IP:RTSP Port/sub
Tertiary Stream	rtsp://IP:RTSP Port/third

Note:

- DSCP refers to the Differentiated Service Code Point; and the DSCP value is used in the IP header to indicate the priority of the data.
- A reboot is required for the settings to take effect.

UPnP

Universal Plug and Play (UPnP) is a networking architecture that provides compatibility among networking equipment, software and other hardware devices. The UPnP protocol allows devices to connect seamlessly and to simplify the implementation of networks in the home and corporate environments. With the function enabled, you don't need to configure the port mapping for each port, and the camera is connected to the Wide Area Network via the router.

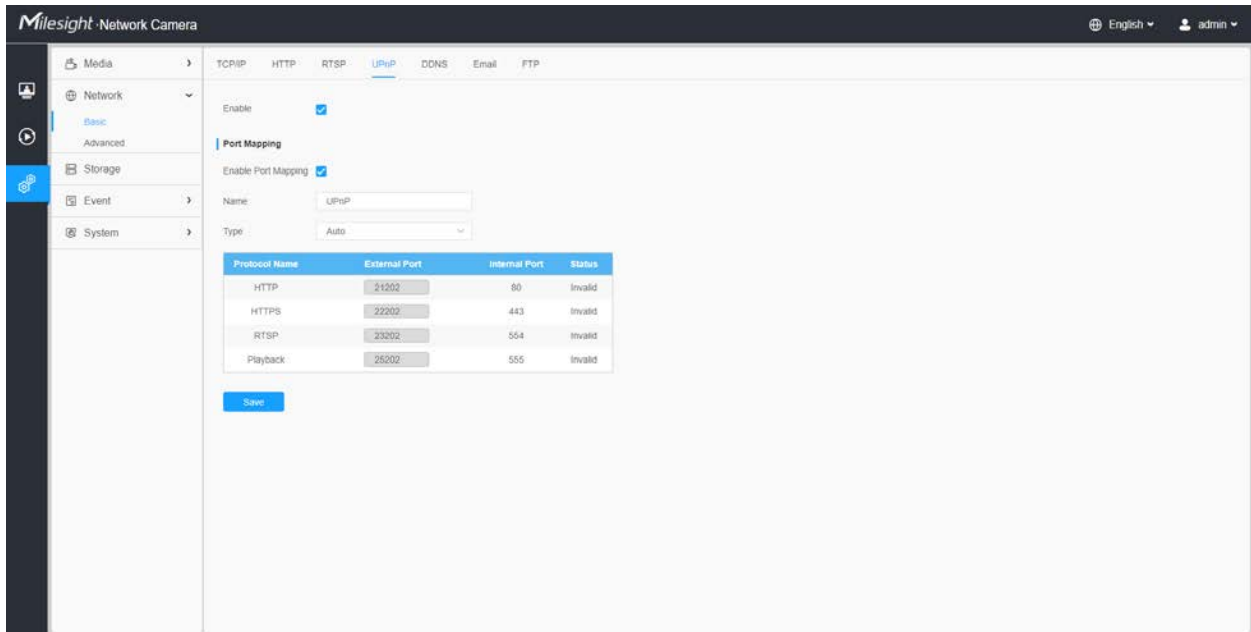

Table 177. Description of the buttons

Parameters	Function Introduction
Enable	Check the checkbox to enable the UPnP function.
Enable Port Mapping	Check the checkbox to enable the Port Mapping
Name	The name of the device detected online can be edited

Parameters	Function Introduction
Type	<p>Auto: Automatically obtain the corresponding HTTP and RTSP port, without any settings</p> <p>Manual: Need to manually set the appropriate HTTP port and RTSP Port. When choose Manual, you can customize the value of the port number by yourself</p>
Save	Save the configuration.

DDNS

DDNS allows you to access the camera via domain names instead of IP address. It manages to change IP address and update your domain information dynamically. You need to register an account from a provider.

 **Note:** For more details about how to set DDNS, please refer to <https://milesight.freshdesk.com/a/solutions/articles/69000643406>.

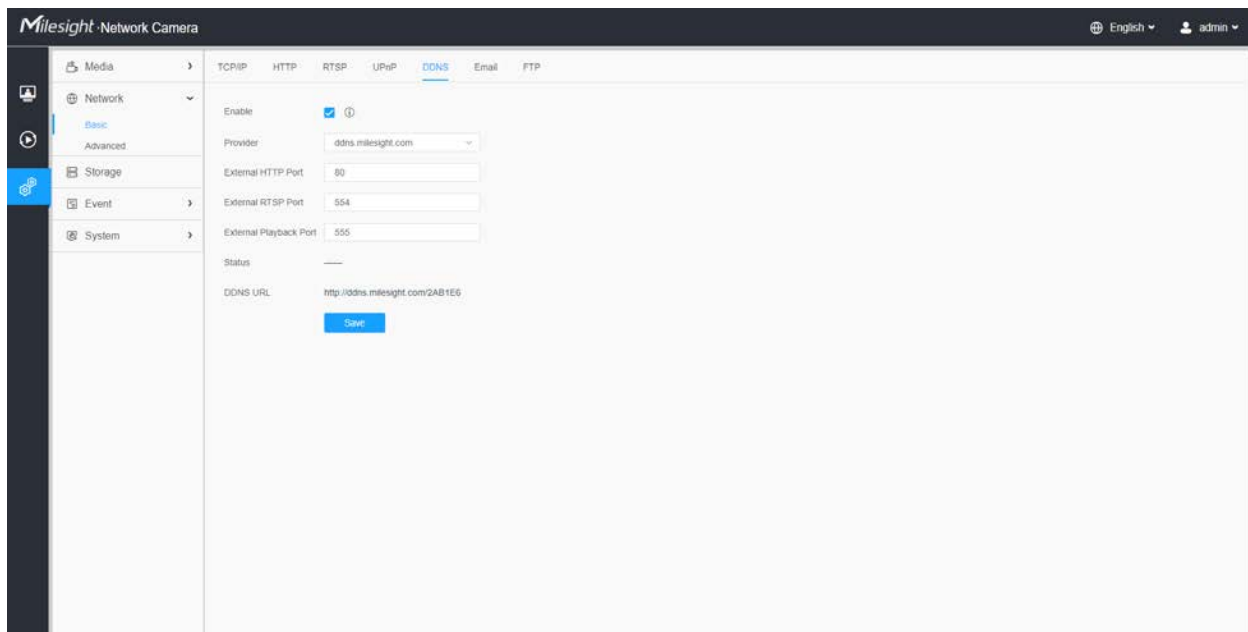

You can choose “ddns.milesight.com” as provider for DDNS. After enabling it, you can access the device via the URL “http://ddns.milesight.com/MAC address”.

Table 178. Description of the buttons

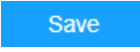
Parameters	Function Introduction
Enable DDNS	Check the checkbox to enable DDNS service.  Note: Recommend to enable and configure UPnP ports which can be used directly in DDNS.
Provider	Get support from DDNS provider: ddns.milesight.com, freedns.afraid.org, dyndns.org, www.no-ip.com, www.zoneedit.com. You can also customize the provider for DDNS.
Hash	A string used for verifying, only for "freedns.afraid.org".
User name	Account name from the DDNS provider, unavailable for "freedns.afraid.org".
Password	Account password, unavailable for "freedns.afraid.org".
Host name	DDNS name enabled in the account.
Status	Display DDNS running status.
	Save the configuration.

 **Note:**

- Please do the Port Forwarding of HTTP Port and RTSP Port before you use Milesight DDNS.
- Make sure that the internal and the external port number of RTSP are the same.

Email

Alarm video files can be sent to specific mail account through SMTP server. You must configure the email settings correctly before using it.

The screenshot shows the 'Email' configuration page in the MileSight Network Camera web interface. The page is divided into a left sidebar with navigation options (Media, Network, Storage, Event, System) and a main content area. The 'Email' tab is selected, showing a form with the following fields and options:

- Enable:** A checked checkbox.
- User Name:** Input field containing '1013698401@qq.com'.
- Sender Email Address:** Input field containing '1013698401@qq.com'.
- Password:** Input field with masked characters '*****'.
- Email Server:** Input field containing 'smtp.qq.com'.
- Email Port:** Input field containing '25'.
- Recipient Email Address1:** Input field containing 'atba@milesight.com'.
- Recipient Email Address2:** Empty input field.
- Encryption:** Radio buttons for 'None' (selected), 'SSL', and 'TLS'.
- Snapshot Settings:**
 - Alarm Snapshot File Name:** Dropdown menu with 'YYYY-MM-DD' selected.
 - Timing Snapshot File Name:** Dropdown menu with 'YYYY-MM-DD' selected.

At the bottom of the form are two buttons: 'Save' and 'Test'.

Table 179. Description of the buttons

Parameters	Function Introduction
Enable	Check the checkbox to enable Email function.
User Name	The sender's name. It is usually the same as the account name.
Sender Email Address	Email address to send video files attached emails.
Password	The password of the sender.
Email Server	The email server IP address or host name(e.g. smtp.gmail.com).
Email Port	The default TCP/IP port for SMTP is 25(not secured). For SSL/TLS port, it depends on the mail you use.
Recipient Email Address1	Email address to receive video files.
Recipient Email Address2	Email address to receive video files.
Encryption	Check the checkbox to enable SSL or TLS if it is required by the SMTP server.

Parameters	Function Introduction
<p align="center">Snapshot Settings</p>	<p>Alarm Snapshot File Name: Default(YYYY-MM-DD) /MM-DD-YYYY/ DD-MM-YYYY/ Add prefix/ Overwrite with the base file name/ Customize are available.</p> <p>Timing Snapshot File Name: Default(YYYY-MM-DD) /MM-DD-YYYY/ DD-MM-YYYY/ Add prefix/ Overwrite with the base file name/ Customize are available.</p>
<p align="center">Save</p>	<p>Save the configuration.</p>
<p align="center">Test</p>	<p>Test whether the configuration is successful.</p>

 **Note:** You can refer to the following file name tip to customize the file name.

File Name Tip

&Device - Device Name

&Y - Year

&M - Month

&D - Day

&h - hour

&m - minute

&s - second

&ms - millisecond

&& - &

FTP

Alarm video files can be sent to specific FTP server. You must configure the FTP settings correctly before using it.

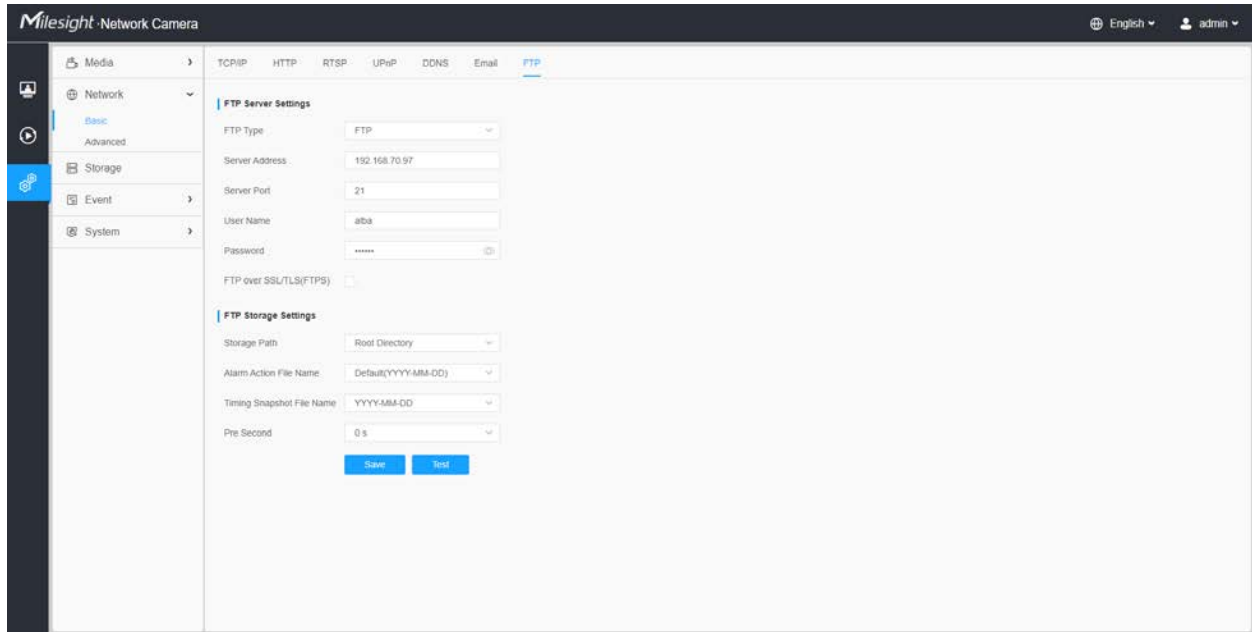

Table 180. Description of the buttons

Parameters		Function Introduction
FTP Server Settings	FTP Type	FTP and SFTP are optional.
	Server Address	FTP/SFTP server address.
	Server Port	The port of the FTP server. Generally it is 21. The port of the SFTP server. Generally it is 22.
	User Name	User name used to log in to the FTP/SFTP sever.
	Password	User password.
FTP Storage Settings	Storage Path	Storage Path where video and image will be uploaded to the FTP server. Four FTP storage path types are available, including Root Directory, Parent Directory, Child Directory and Customize.
	Parent Directory	Choose IP Address/ Device Name/ Date as the folder name of Parent Directory, or customize the folder name.
	Child Directory	Choose IP Address/ Device Name/ Date as the folder name of Child Directory, or customize the folder name.

Parameters		Function Introduction
FTP Storage Settings	Multilevel Folder Name	If the storage path is more than two levels, enter Multilevel FTP storage path here manually.
	Alarm Action File Name	Choose the default(YYYY-MM-DD) or customize the alarm action file name.
	Video File Name	If you choose to customize the alarm action file name, YYYY-MM-DD/ MM-DD-YYYY/ DD-MM-YYYY/ Add prefix are available.
	Image File Name	If you choose to customize the alarm action file name, YYYY-MM-DD/ MM-DD-YYYY/ DD-MM-YYYY/ Add prefix are available.
	Timing Snapshot File Name	Default(YYYY-MM-DD) /MM-DD-YYYY/ DD-MM-YYYY/ Add prefix/ Overwrite with the base file name are available.
	Pre Second	Reserve the record time before alarm, 0~10 sec.
Save		Save the configuration, 0s ~ 10s are optional.
Test		Test whether the configuration is successful.

 **Note:**

- Parent Directory will be under Root Directory, and Child Directory will be under Parent Directory.
- You can refer to the following file name tip to customize the file name.

Advanced

VLAN

A virtual LAN (VLAN) is any broadcast domain that is partitioned and isolated in a computer network at the data link layer (OSI layer 2). LAN is an abbreviation of local area network. VLANs allow network administrators to group hosts together even if the hosts are not on the same network switch. This can greatly simplify network design and deployment, because VLAN membership can be configured through software. Without VLANs, grouping hosts according to their resource needs necessitates the labour of relocating nodes or rewiring data links.

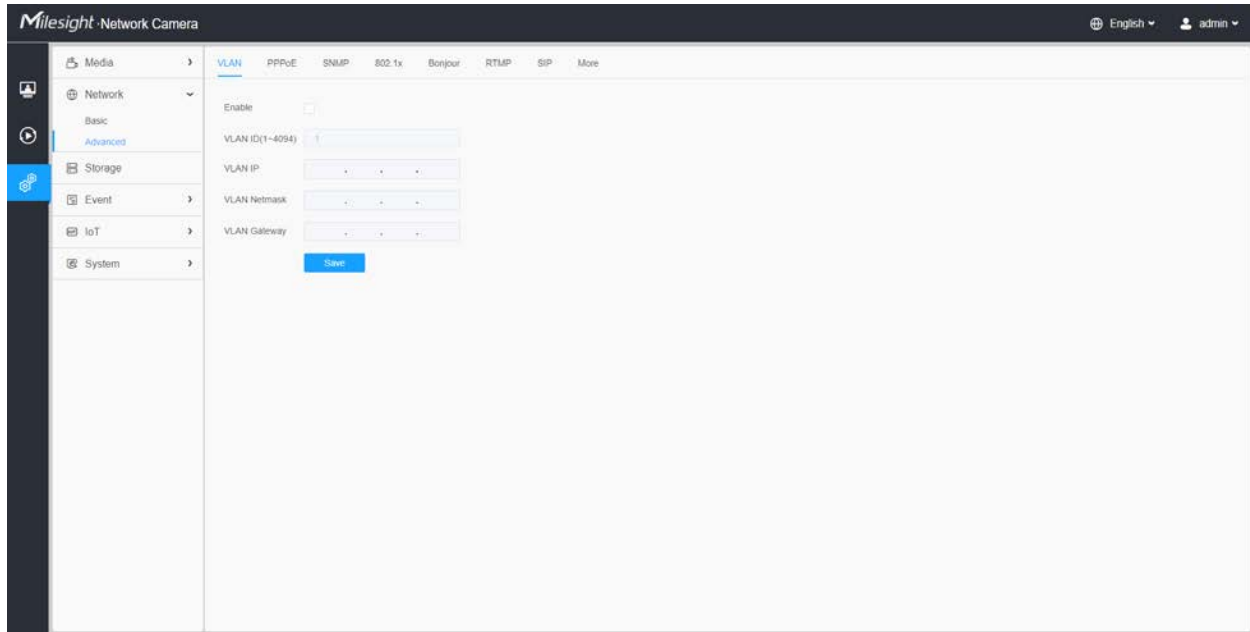

Note: About how to set up VLAN in switches, please refers to your switches user manual.

PPPoE

This camera supports the PPPoE auto dial-up function. The camera gets a public IP address by ADSL dial-up after the camera is connected to a modem. You need to configure the PPPoE parameters of the network camera.

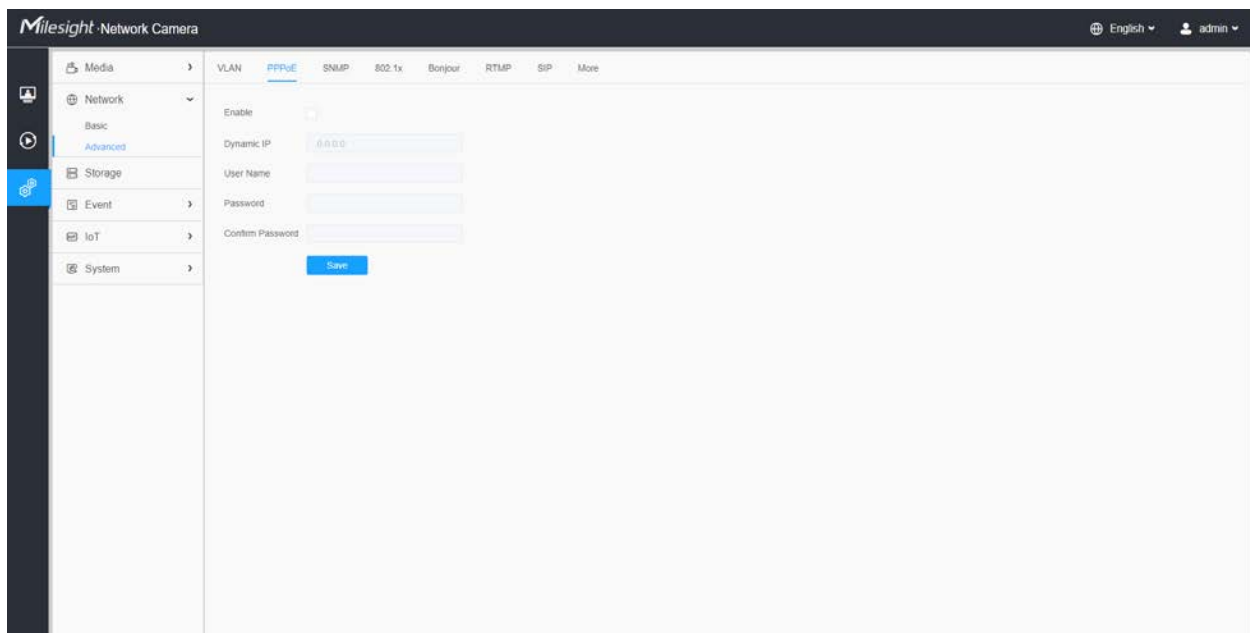

Note:

- The obtained IP address is dynamically assigned via PPPoE, so the IP address always changes after rebooting the camera. To solve the inconvenience of the dynamic IP, you need to get a domain name from the DDNS provider (e.g. DynDns.com).
- The user name and password should be assigned by your ISP.

SNMP

You can set the SNMP function to get camera status, parameters and alarm related information and manage the camera remotely when it is connected to the network.

Before setting the SNMP, please download the SNMP software and manage to receive the camera information via SNMP port. By setting the Trap Address, the camera can send the alarm event and exception messages to the surveillance center.

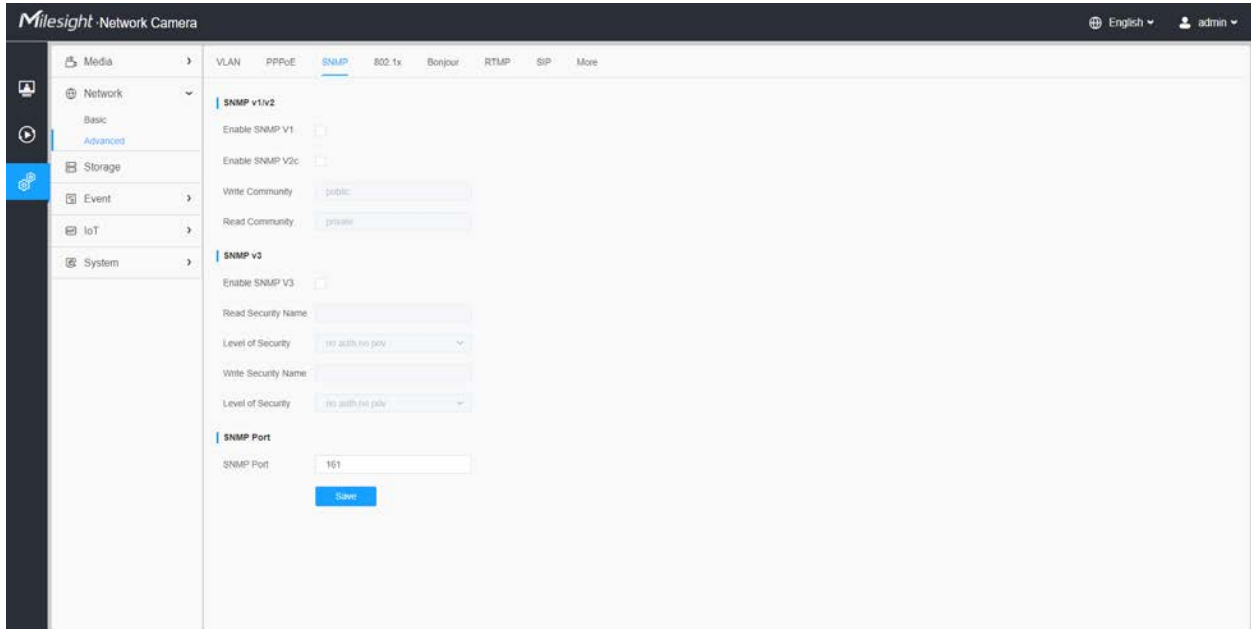

Table 181. Description of the buttons

Parameters	Function Introduction
<p>SNMP v1/v2</p>	<p>The version of SNMP, please select the version of your SNMP software.</p> <p>Enable SNMP v1: Provide no security.</p> <p>Enable SNMP v2: Require password for access.</p> <p>Write Community: Input the name of Write Community.</p> <p>Read Community: Input the name of Read Community</p>

Parameters	Function Introduction
SNMP v3	<p>Enable SNMP v3: Provide encryption and the HTTPS protocol must be enabled.</p> <p>Read Security Name: Input the name of Read Security Community.</p> <p>Level of Security: There are three levels available: (auth, priv), (auth, no priv) and (no auth, no priv).</p> <p>Write Security Name: Input the name of Write Security Community.</p> <p>Level of Security: There are three levels available: (auth, priv), (auth, no priv) and (no auth, no priv).</p>
SNMP Port	The port of SNMP, the default is 161.
Save	Save the configuration.

 **Note:**

- The settings of SNMP software should be the same as the settings you configure here;
- A reboot is required for the settings to take effect.

802.1x

The IEEE 802.1X standard is supported by the network cameras, and when the feature is enabled, the camera data is secured and user authentication is needed when connecting the camera to the network protected by the IEEE 802.1X.

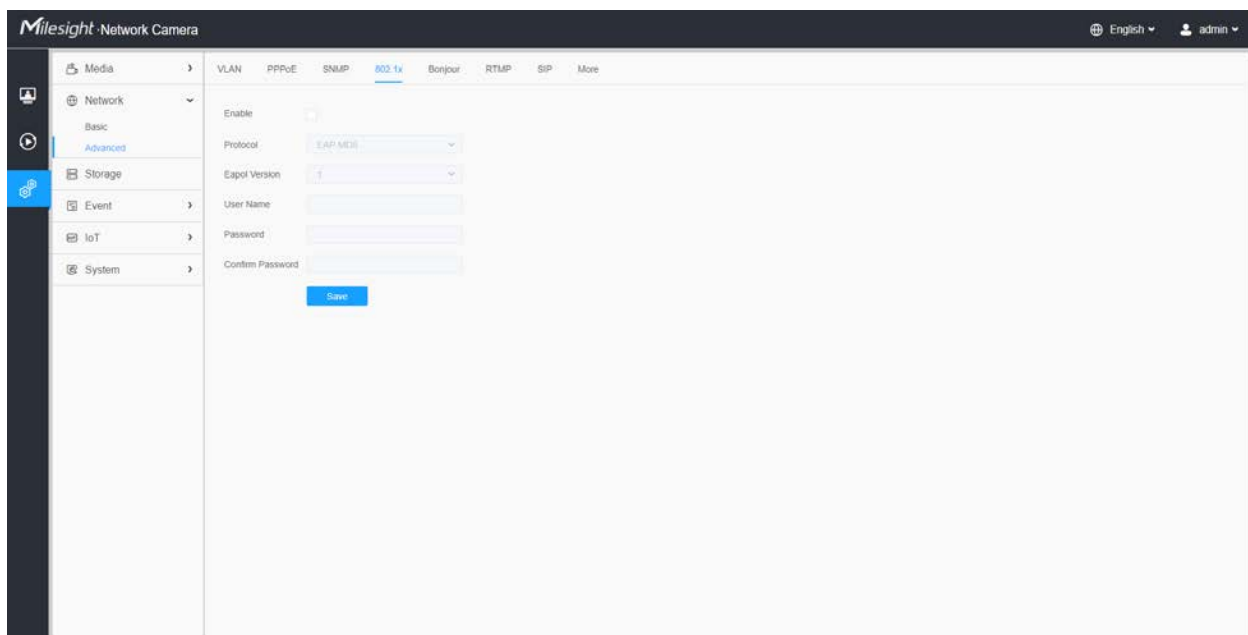

Bonjour

Bonjour is based on Apple's multicast DNS service. Bonjour devices can automatically broadcast their service information and listen to the service information of other devices.

If you don't know the camera information, you can use the Bonjour service on the same LAN to search for network camera devices and then to access the devices.

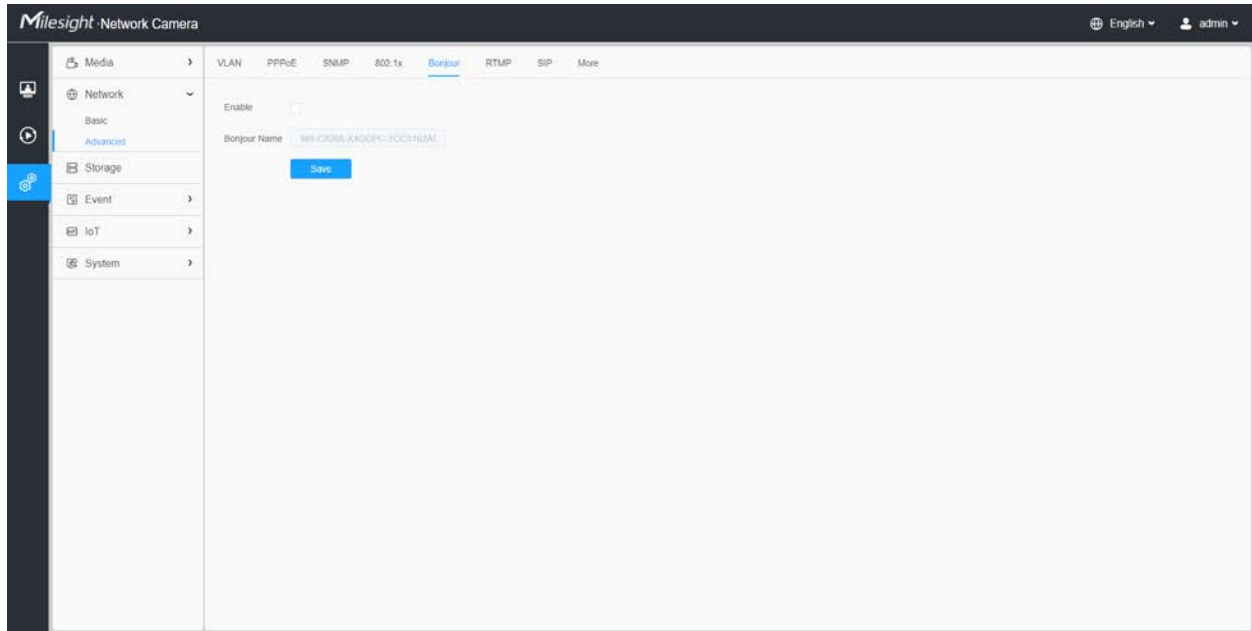

RTMP

Real-Time Messaging Protocol (RTMP) was initially a proprietary protocol for streaming audio, video and data over the Internet, between a Flash player and a server. RTMP is a TCP-based protocol which maintains persistent connections and allows low-latency communication. It can realize the function of live broadcast so that customers can log in to the camera wherever there is a network.

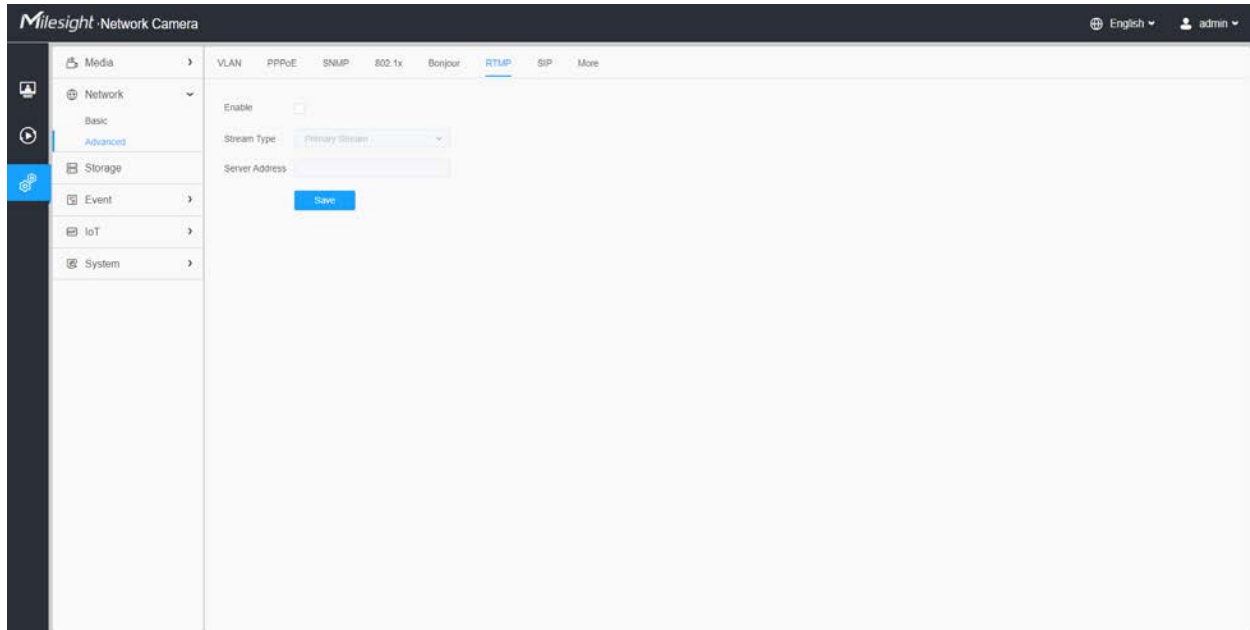

Note:

- For YouTube live broadcast, if you use a newly created account to live broadcast, you need to wait for 24hrs to activate the account for using live function.
- For RTMP, since G.711 is not available for YouTube, so you can only play video from MileSight Network Camera with H.264 video coding and AAC audio coding on YouTube.
- Server Address in Network Camera RTMP interface needs to be filled with the format: `rtmp://< Server URL >/< Stream key >`, remember it needs '/' to connect between < Server URL > and < Stream key >.
- For more details about how to use RTMP for live broadcast, please refer to <https://milesight.freshdesk.com/a/solutions/articles/69000643313>.

SIP

The Session Initiation Protocol(SIP) is a signaling communications protocol, widely used for controlling multimedia communication sessions such as voice and video calls over Internet Protocol (IP) networks. This page allows user to configure SIP related parameters. MileSight Network cameras can be configured as SIP endpoint to call out when alarm triggered; or allow permitted number to call in to check the video if the video IP phone is used.

 **Note:** For more details about how to use SIP, please refer to <https://milesight.freshdesk.com/a/solutions/articles/69000643391>.

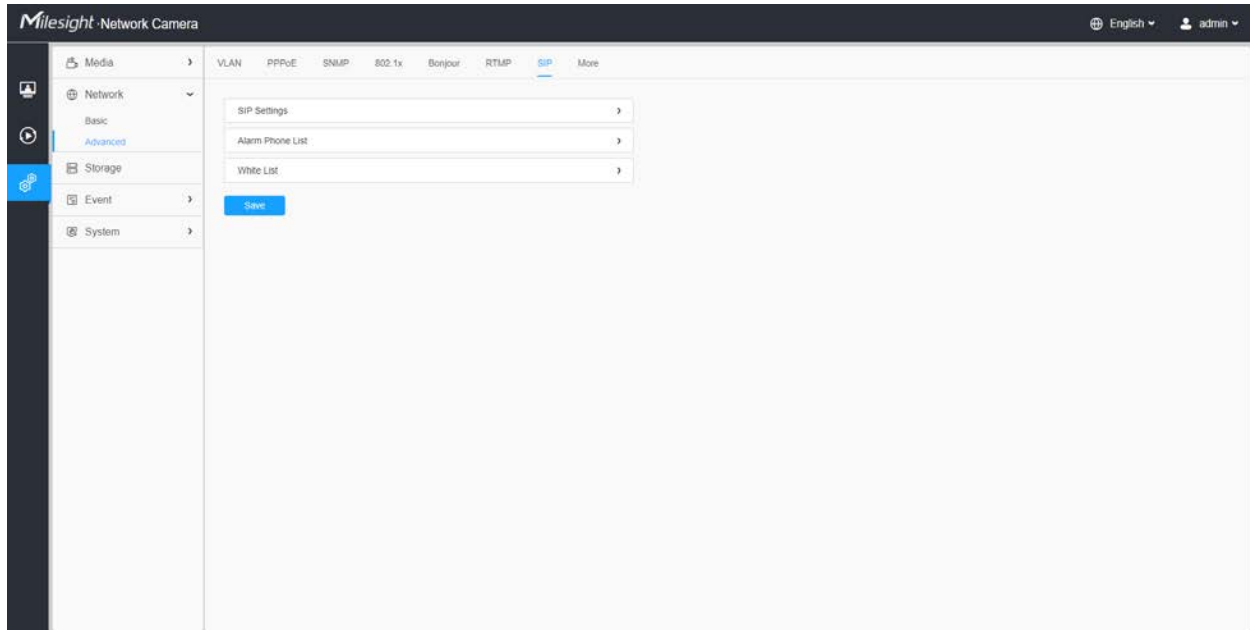

To use this function, the settings in SIP page must be configured properly. There are two ways to get video through SIP, one is to dial the IP address directly, the other is account registration mode. the details are as follows:

Method 1: IP Direct mode

Dial on the camera's IP address directly through SIP phone, so you can see the video.

 **Note:** SIP phone and the camera should in the same network segment.

Method2: Account registration mode

- Before using the SIP, you need to register an account for the camera from the SIP server;
- Register another user account for the SIP device from the same SIP server;
- Call the camera User ID from the SIP device, you will get the video on the SIP device.

[SIP Settings]

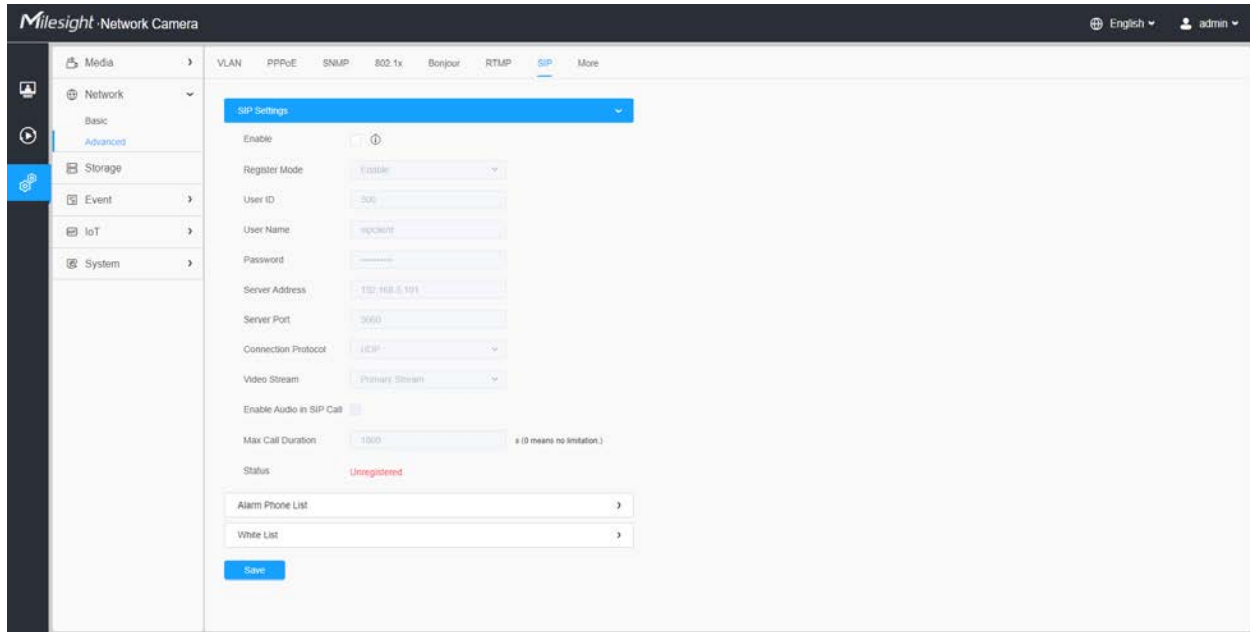



Table 182. Description of the buttons

Parameters	Function Introduction
Enable	Start or stop using SIP.  Note: SIP supports Direct IP call.
Register Mode	Choose to use Enable mode or Disable mode. Enable mode means to use SIP with register account. Disable mode refers to use SIP without register account, just use the IP address to call.
User ID	SIP ID.
User Name	SIP account name.
Password	SIP account password.
Server Address	Server IP address.
Server Port	Server port.
Connection Protocol	UDP/TCP.
Video Stream	Choose the video stream.

Parameters	Function Introduction
Enable Audio in SIP Call	Enable/disable audio in SIP call.
Max Call Duration	The max call duration when use SIP.
Status	SIP registration status. Display “Unregistered” or “Registered” .

[Alarm Phone List]

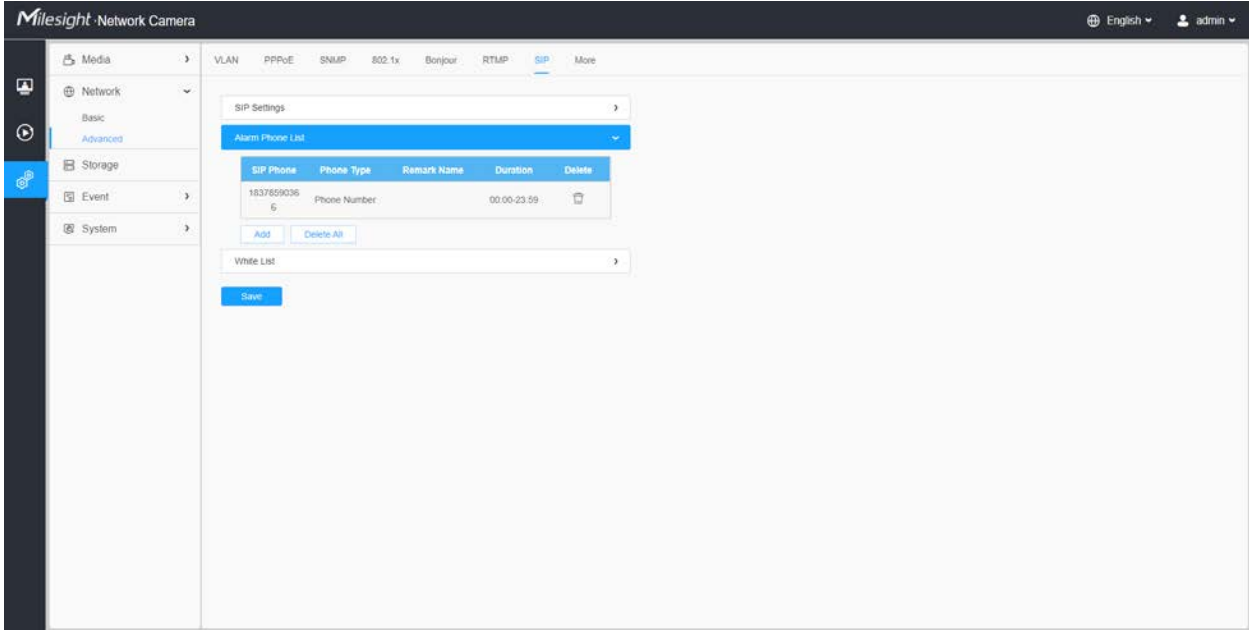
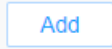

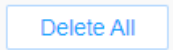

Table 183. Description of the buttons

Parameters	Function Introduction
	Add alarm phone to the camera. Phone Type: Phone Number(Call by phone number) & Direct IP Call(Check to accept peer to peer IP call). To Phone Number/IP Address: Call by phone number or IP address. Remark Name: Display name. Duration: The time schedule to use SIP.
	Delete the selected alarm phone.
	Delete all added alarm phone.

[White List]

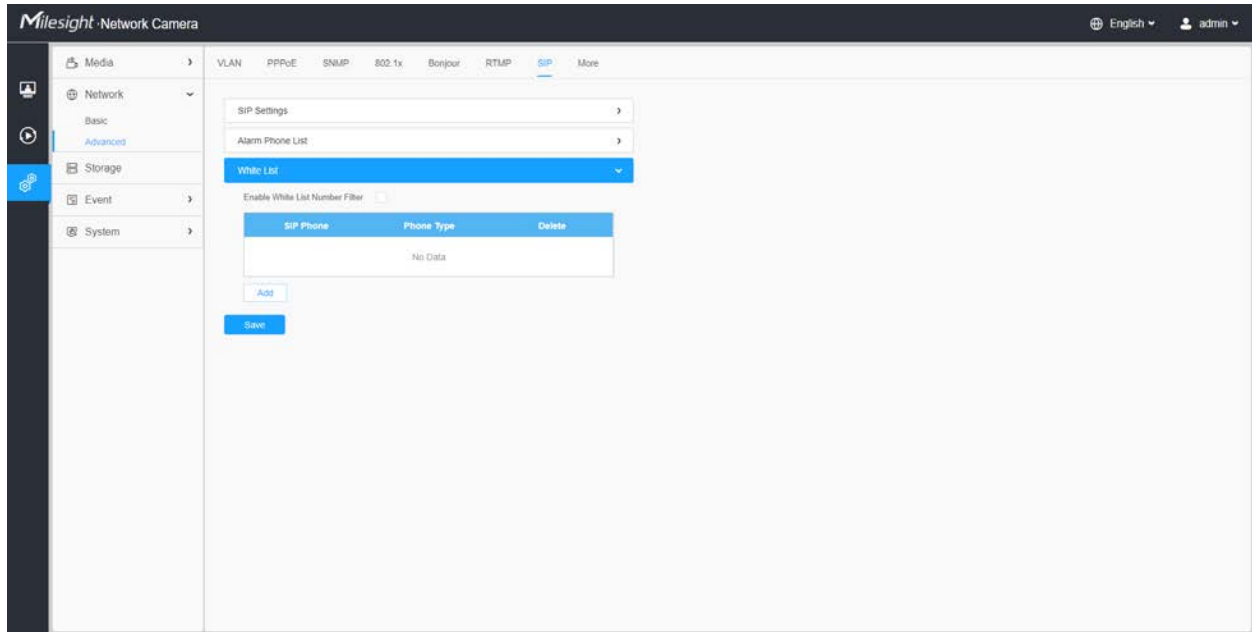
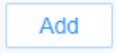

Table 184. Description of the buttons

Parameters	Function Introduction
<p>Enable White List Number Filter</p>	<p>When enabled, only the designated phone number or IP address can visit</p>
<p></p>	<p>Phone Type: Phone Number(Call by phone number) & Direct IP Call. Phone Number/IP Address: Including the phone number or IP address on the white list.</p>

More

Here you can set more functions, like Push Message Settings and ONVIF Settings.

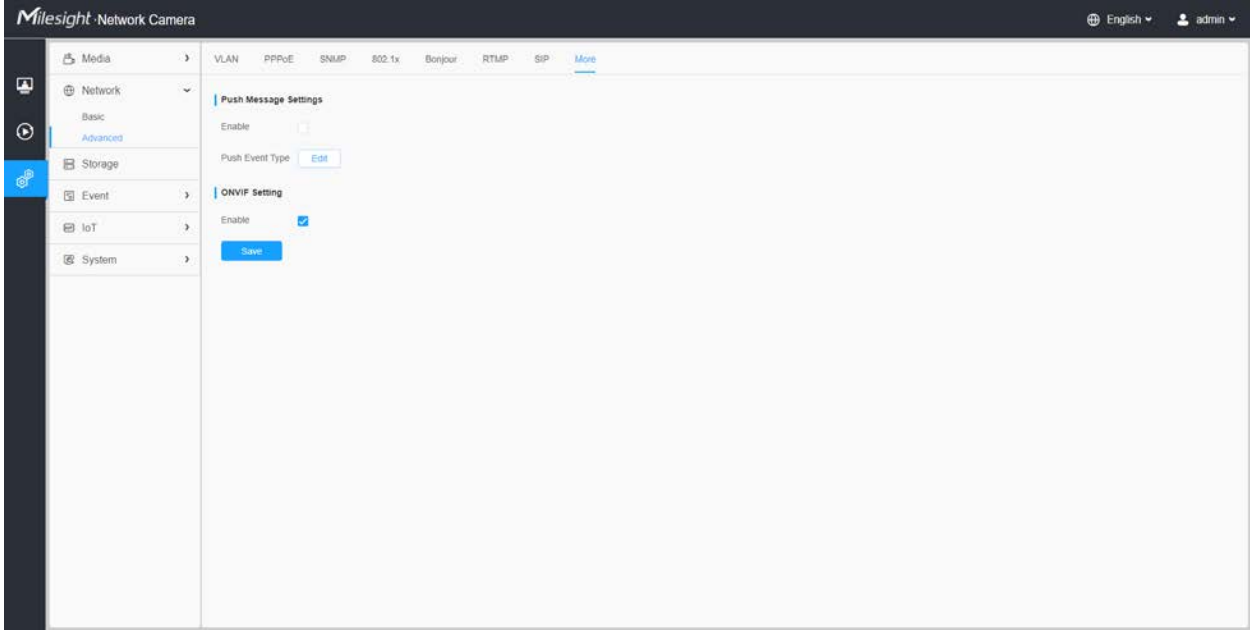
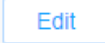
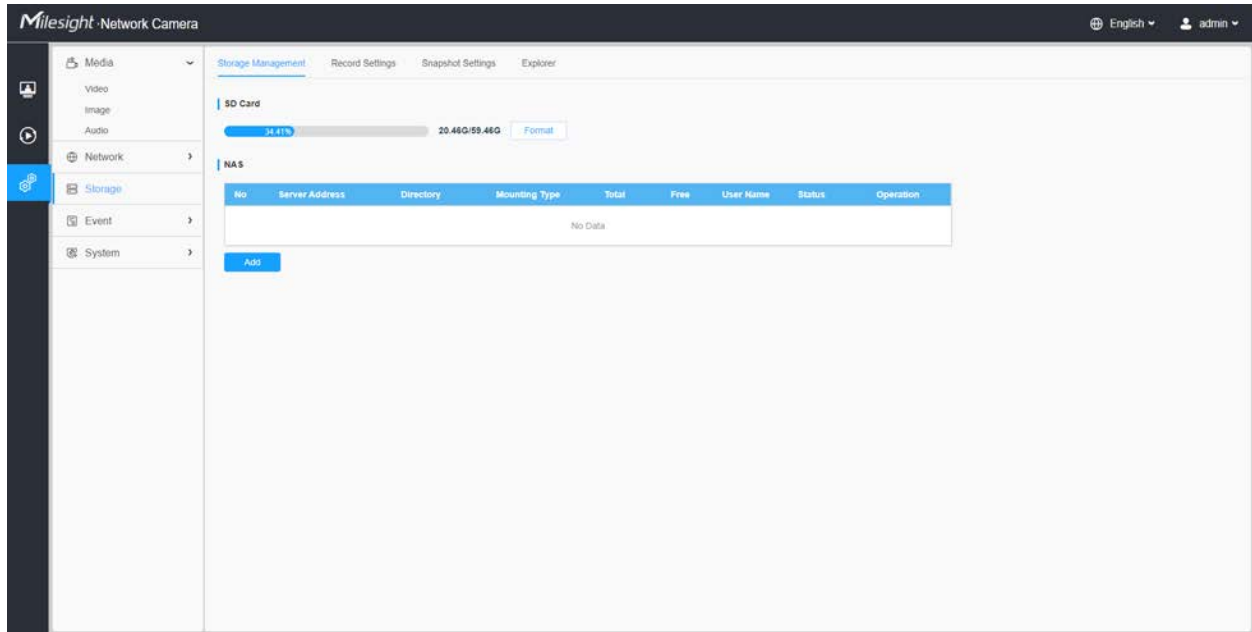

Table 185. Description of the buttons

Parameters	Function Introduction
<p>Push Message Settings</p>	<p>Enable: Enable/disable the Push Message function</p> <p>Push Event Type: You can click  to choose the types of Events' message which will be pushed to M-sight Pro App as shown below:</p> <div data-bbox="578 1146 1373 1482" style="border: 1px solid #ccc; padding: 10px; background-color: #f9f9f9;"> <p style="text-align: center; border-bottom: 1px solid #ccc; margin-bottom: 10px;">Edit ×</p> <p>Push Event Type</p> <p><input checked="" type="checkbox"/> All</p> <p><input checked="" type="checkbox"/> Motion Detection <input checked="" type="checkbox"/> Audio Alarm <input checked="" type="checkbox"/> External Input</p> <p style="text-align: center; margin-top: 10px;"><input type="button" value="Save"/> <input type="button" value="Cancel"/></p> </div>
<p>ONVIF Setting</p>	<p>Here you can choose whether to enable or disable camera ONVIF function. If camera ONVIF function is enabled, it can be searched out, added and connected by third-party software through ONVIF protocols. Generally, the default status of ONVIF function is enabled.</p>

4.7.3 Storage

Storage Management



Note: Before you start:

- To configure record settings, please make sure that you have the network storage device within the network or the SD card inserted in your camera.
- Choose the storage mode according to your needs.

Table 186. Description of the buttons

Parameters	Function Introduction
SD Card	<p>Format: Format SD card, the files in SD card will be removed.</p> <p>Mount/UnMount: Mount/Dismount SD card.</p> <p>Delete: Enable cyclic storage, when the free disk space reach at a certain value, it will automatically delete the files at certain percentage according to your settings.</p>

Parameters	Function Introduction
<p style="text-align: center;">Nas</p>	<p>The network disk should be available within the network and properly configured to store the recorded files, etc.</p> <p>NAS (Network-Attached Storage), connecting the storage devices to the existing network, provides data and files services.</p> <div data-bbox="607 459 1403 852" style="border: 1px solid #ccc; padding: 10px; margin: 10px 0;"> <div style="background-color: #007bff; color: white; padding: 5px; display: flex; justify-content: space-between; align-items: center;"> Add × </div> <div style="padding: 10px;"> <p>Server Address* <input style="width: 100%;" type="text"/></p> <p>Directory* <input style="width: 100%;" type="text"/></p> <p>Mounting Type NFS ▼</p> <div style="display: flex; justify-content: center; gap: 20px; margin-top: 10px;"> Save Cancel </div> </div> </div> <p>Server Address: IP address of NAS server.</p> <p>Directory: Input the NAS directory, e.g. “\path”.</p> <p>Mounting Type: NFS and SMB/CIFS are available. And you can set the user name and password to guarantee the security if SMB/CIFS is selected.</p> <p> Note:</p> <ul style="list-style-type: none"> Up to 5 NAS disks can be connected to the camera. For more details about how to use NAS on Milesight Network Camera, please refer to https://milesight.freshdesk.com/a/solutions/articles/69000797902.

Record Settings

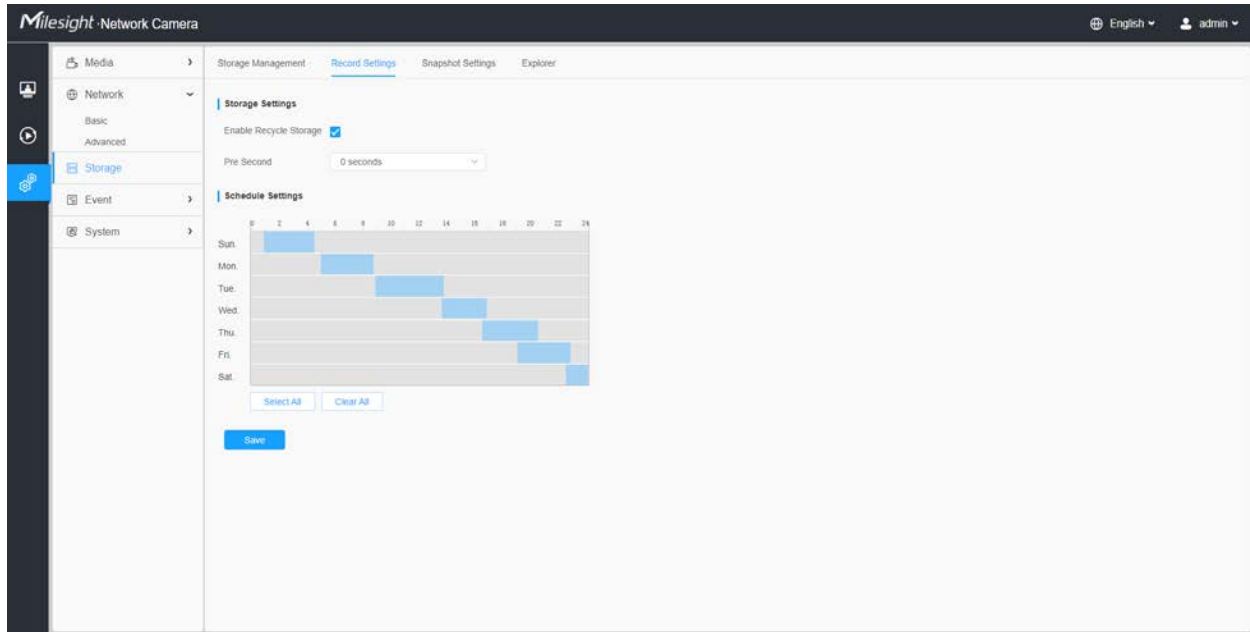
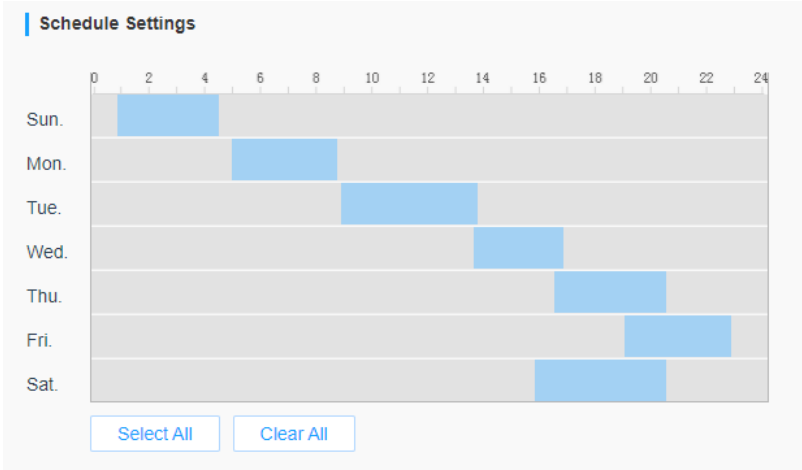
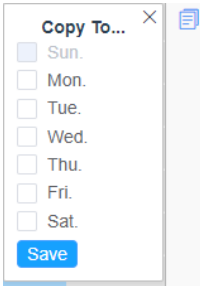
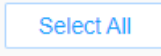
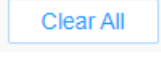
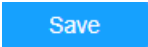



Table 187. Description of the buttons

Parameters	Function Introduction
Enable Recycle Storage	Enable/Disable Recycle Storage, if you enable this option, it will delete the files when the free disk space reaches a certain value.
Pre Second	Reserve the record time before alarm, 0~10 sec.
Schedule Settings	Edit record schedule as needed. Intuitive scheduling by drawing the time bar directly. 

Parameters	Function Introduction	
<p>Schedule Settings</p>		<p>Copy the schedule area to another date.</p>
		<p>Select all schedule.</p>
		<p>Clear all schedule.</p>
	<p>Save the configuration.</p>	

 **Note:** SD Card or NAS are available.

Snapshot Settings

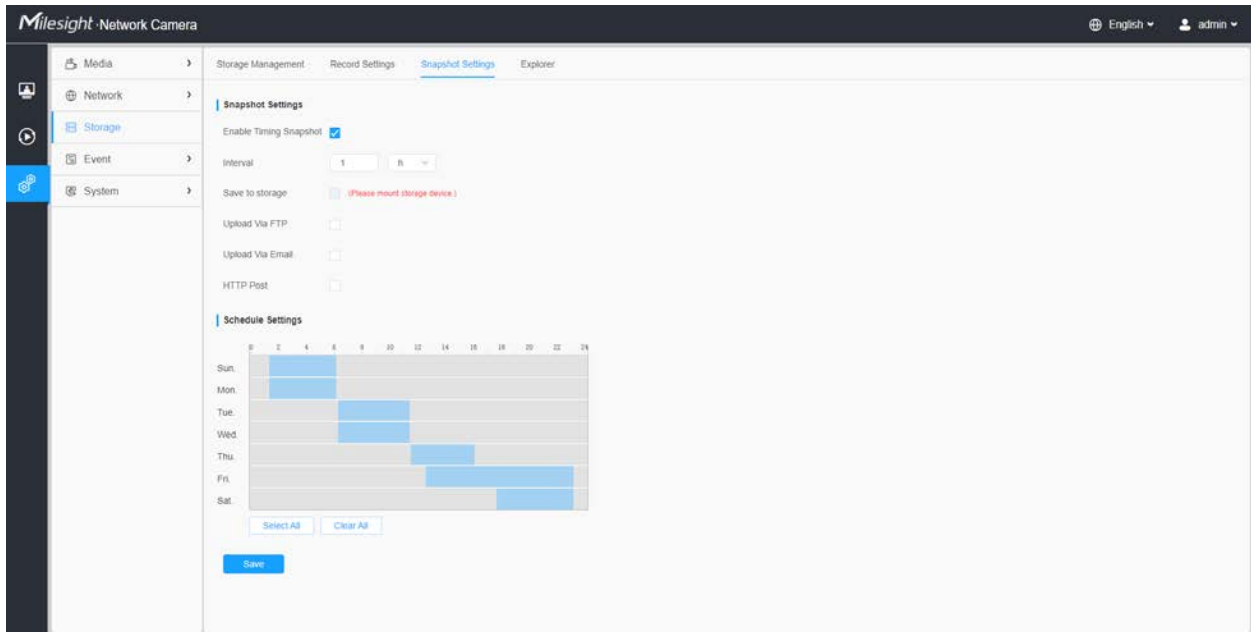

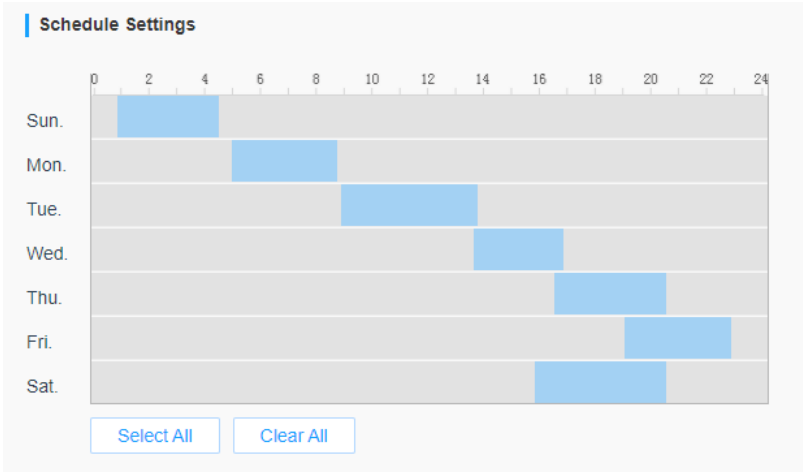
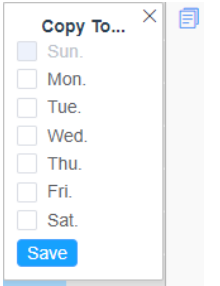
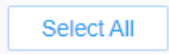



Table 188. Description of the buttons

Parameters	Function Introduction	
<p>Snapshot Settings</p>	<p>Enable Timing Snapshot: Check the checkbox to enable the Timing Snapshot function</p> <p>Interval: Set the snapshots interval, input the number and choose the unit(millisecond, second, minute, hour, day).</p> <p>Save Into Storage: Save the snapshots into SD card or NAS, and choose the file name to add time suffix or overwrite the base file name.</p> <p>Save Into NAS: Save the snapshots into NAS, and choose the file name to add time suffix or overwrite the base file name.</p> <p>Upload Via FTP: Upload the snapshots via FTP.</p> <p>Upload Via Email: Upload the snapshots via Email.</p> <p> Note: If you choose to add time suffix, every snapshot picture will be saved, but if you choose to overwrite the base file name, only one latest picture will be saved. When you choose add overwrite the base file name to SD Card or NAS, it will create a file named "Snapshot" to place the snapshot.</p> <p>HTTP Post: Upload the snapshots via HTTP Post. Support uploading the snapshots to specified HTTP URL.</p>	
<p>Schedule Settings</p>	<p>Edit record schedule as needed. Intuitive scheduling by drawing the time bar directly.</p> 	
<p>Schedule Settings</p>		<p>Copy the schedule area to another date.</p>
		<p>Select all schedule.</p>

Parameters	Function Introduction	
	<div style="border: 1px solid #ccc; padding: 2px; display: inline-block;">Clear All</div>	Clear all schedule.
<div style="background-color: #007bff; color: white; padding: 5px; display: inline-block;">Save</div>	Save the configuration.	

Explorer

Files will be seen on this page when they are configured to save into SD card or NAS. You can set time schedule every day for recording videos and save video files to your desired location.

 **Note:** Files are visible once SD card is inserted. Don't insert or pull out SD card when power on

Video files are arranged by date. Set file type and start/end time to search out files. Each day files will be displayed under the corresponding date, from here you can copy and delete files etc. You can visit the files in SD card by ftp, for example, ftp://username:password@192.168.5.190(user name and password are the same as the camera account and the IP followed is the IP of your device.).

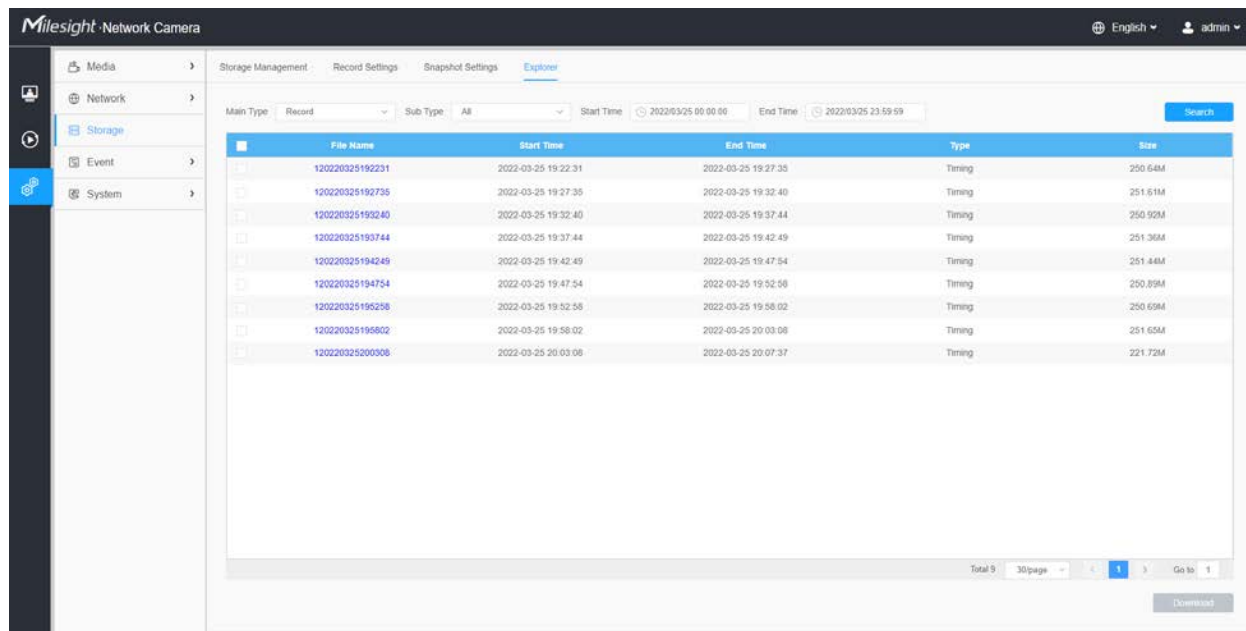

4.7.4 Event

Basic Event

Motion Detection

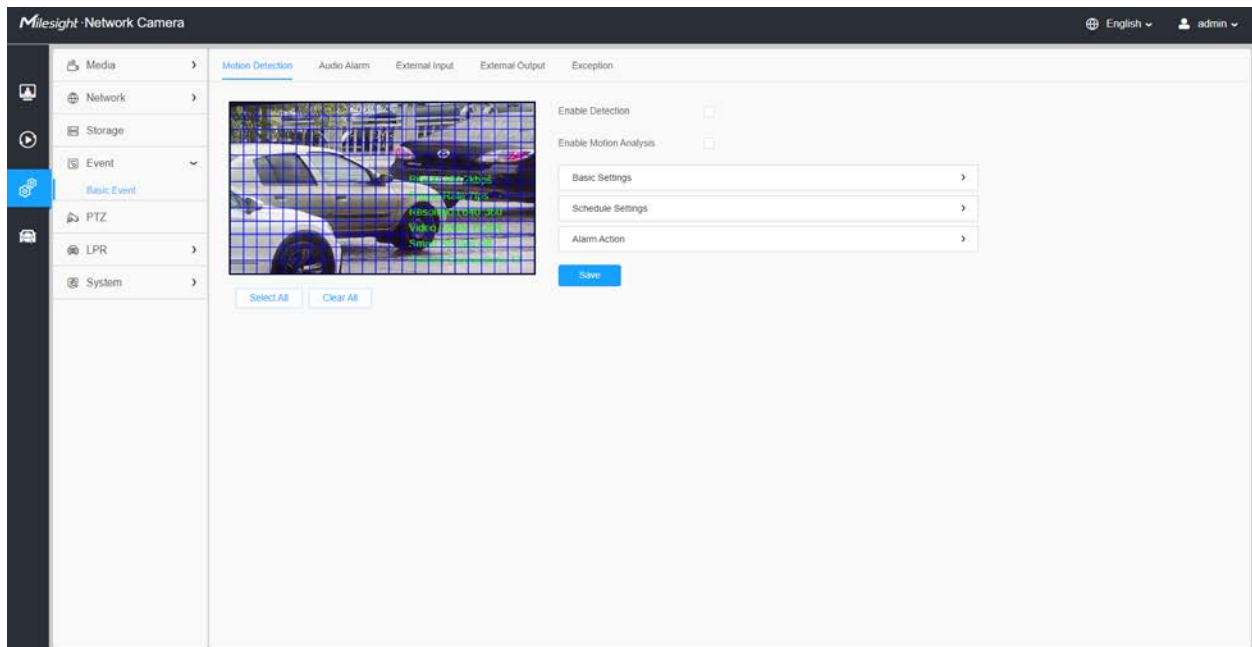

 **Note:** For more details about how to set motion detection, please refer to <https://milesight.freshdesk.com/a/solutions/articles/69000643423>.

Settings steps are shown as follows:

Step1: Check the checkbox to enable the motion detection.

Step2: Check the check box to enable the motion analysis.

Step3: Select the detection mode;

Step4: Set motion region;

Table 189. Description of the buttons

Parameters	Function Introduction
Enable Detection	Check the checkbox to enable Motion Detection function.

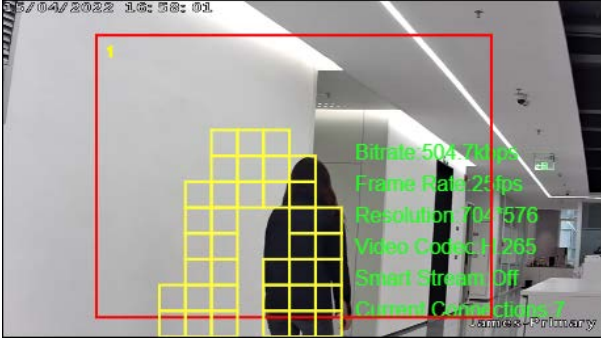
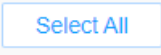
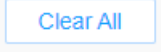
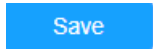
Parameters	Function Introduction
<p>Enable Motion Analysis</p>	<p>When Motion Analysis is enabled, the moving region will turn yellow so that the user can know exactly where the motion occurred.</p> <p> Note: Only support when HTTP is selected in Live View.</p> 
<p></p>	<p>Click the button, the motion in the area will be detected.</p>
<p></p>	<p>Click the button, the area drawn before will be removed.</p>
<p></p>	<p>Save the configuration.</p>

[Basic Settings]

Enable Detection

Enable Motion Analysis

Basic Settings ▾

Mode Normal Mode Advanced Mode

Sensitivity 9

Onvif Motion ActiveCells Settings ▾

Schedule Settings >

Alarm Action >



Table 190. Description of the buttons

Parameters	Function Introduction
Detection Mode	Normal Mode and Advanced Mode are available for the option. When Advanced Mode is selected, users can configure up to 4 detection regions and sensitivity for each detection region.
Sensitivity	Sensitivity level, 1~10
Onvif Motion ActiveCells Settings	Normal and Compatible are available for the option. If the setting of motion region of the third-party software is different from ours, please set this option to Compatible

[Schedule Settings]

Step5: Set motion detection schedule;

Enable Detection

Enable Motion Analysis

Basic Settings >

Schedule Settings v

0 2 4 6 8 10 12 14 16 18 20 22 24

Sun.

Mon.

Tue.

Wed.

Thu.

Fri.

Sat.

Select All Clear All

Alarm Action >

Save

Table 191. Description of the buttons

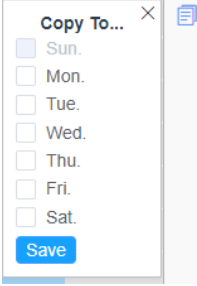
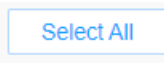
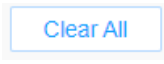
Parameters	Function Introduction
	<p>Copy the schedule area to another date.</p>
	<p>Select all schedule.</p>
	<p>Clear all schedule.</p>

[Alarm Action]

Step6: Set alarm action;

Enable Detection

Enable Motion Analysis

Basic Settings >

Schedule Settings >

Alarm Action ▾

Record >

Snapshot >

External Output >





Play Audio (Please enable the Audio Speaker.)

Alarm to SIP Phone (Please open the SIP.)

HTTP Notification >

Save

Table 192. Description of the buttons

Parameters	Function Introduction
Record	<p>Duration: Selected the duration time of alarm. 5s/10s/15s/20s/25s/30s are available.</p> <p>Linkage: Save alarm recording files into SD Card or NAS or Upload the recording files via FTP.</p>
Snapshot	<p>Number: The number of snapshot, 1~5 are available.</p> <p>Interval: This cannot be edited unless you choose more than 1 to Snapshot.</p> <p>Linkage: Save alarm recording files into SD Card or NAS, Upload the recording files via FTP and send alarm email.</p>
External Output	If the camera equips with External Output, you can enable the action after configuring the trigger duration.
Play Audio	<p>Auto/10 seconds/30 seconds/1 minute/5 minutes/10 minutes are available.</p> <p> Note: Please enable the Audio Speaker.</p>
Alarm to SIP Phone	Support to call the SIP phone after enable the SIP function.
HTTP Notification	<p>Support to pop up the alarm news to specified HTTP URL.</p> <p> Note:</p> <ul style="list-style-type: none"> • Three HTTP notifications at most can be added to the same event. • HTTP Notification supports Basic & Digest authentication
White LED	<p>When the alarm triggered, White LED will turn on to warn the detected objects.</p> <p> Note: Only for PTZ Bullet.</p>
PTZ Motion	<p>When the motion alarm triggered, PTZ Motion allows the camera move the lens to the motion triggered position and zoom in.</p> <p> Note: Only for PTZ series.</p>
Call Preset/ Call Patrol/Call Pattern (Only for External Input)	<p>When the motion alarm triggered, the specified preset/patrol/pattern can be called.</p> <p> Note: Only for PTZ series.</p>

Audio Alarm

Check the check box to enable the Audio Alarm function.

 **Note:** Enable the Audio Mic before using Audio Alarm function.

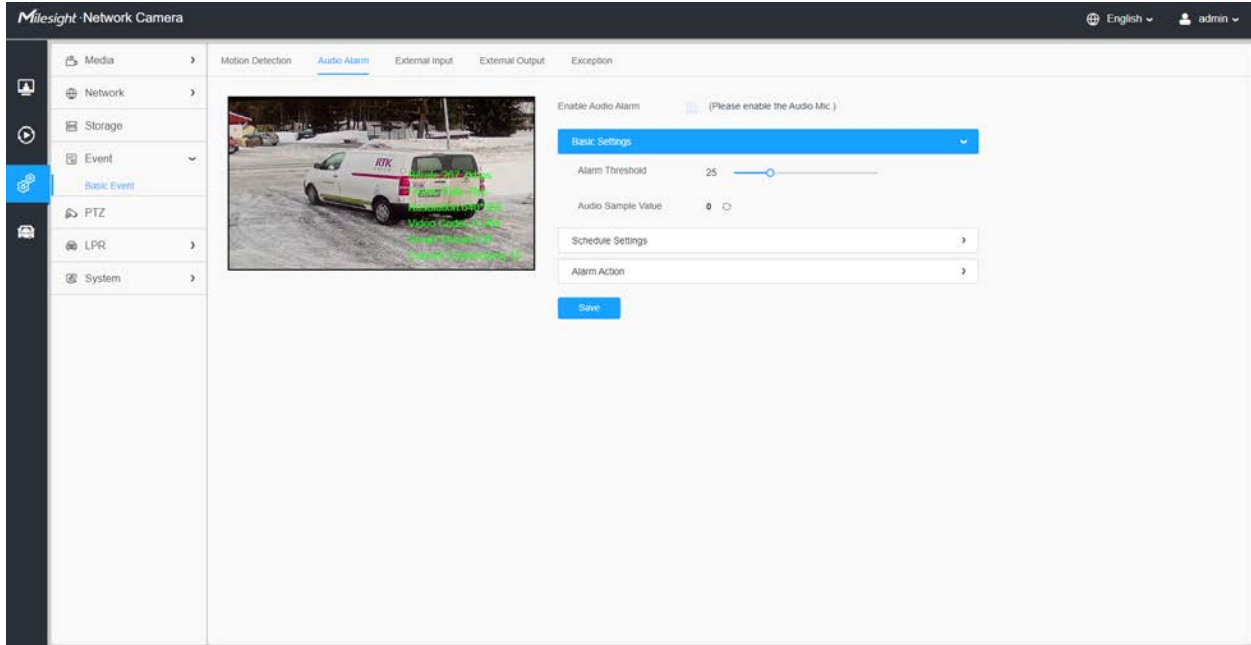

[Basic Settings]

Table 193. Description of the buttons

Parameters	Function Introduction
Alarm Threshold	Audio Alarm will be triggered when the thresholds reaches to a certain value from 0 to 100.
Audio Sample Value	The current value of the audio sample.

[Schedule Settings]

Refer to the table [Table 3 \(page 85\)](#) for the meanings of the items, here will not repeat again.

[Alarm Action]

Refer to the table [Table 4 \(page 86\)](#) for the meanings of the items, here will not repeat again.

External Input

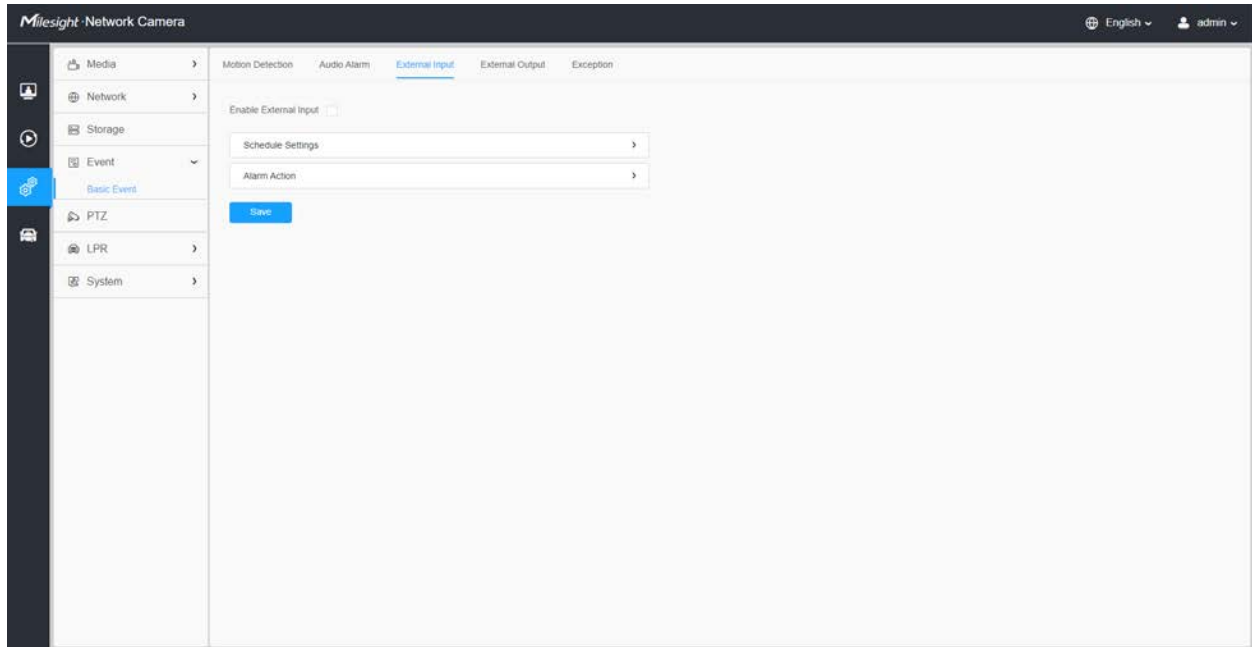

Refer to the table [Table 3 \(page 85\)](#) for the meanings of the items, here will not repeat again.

External Output

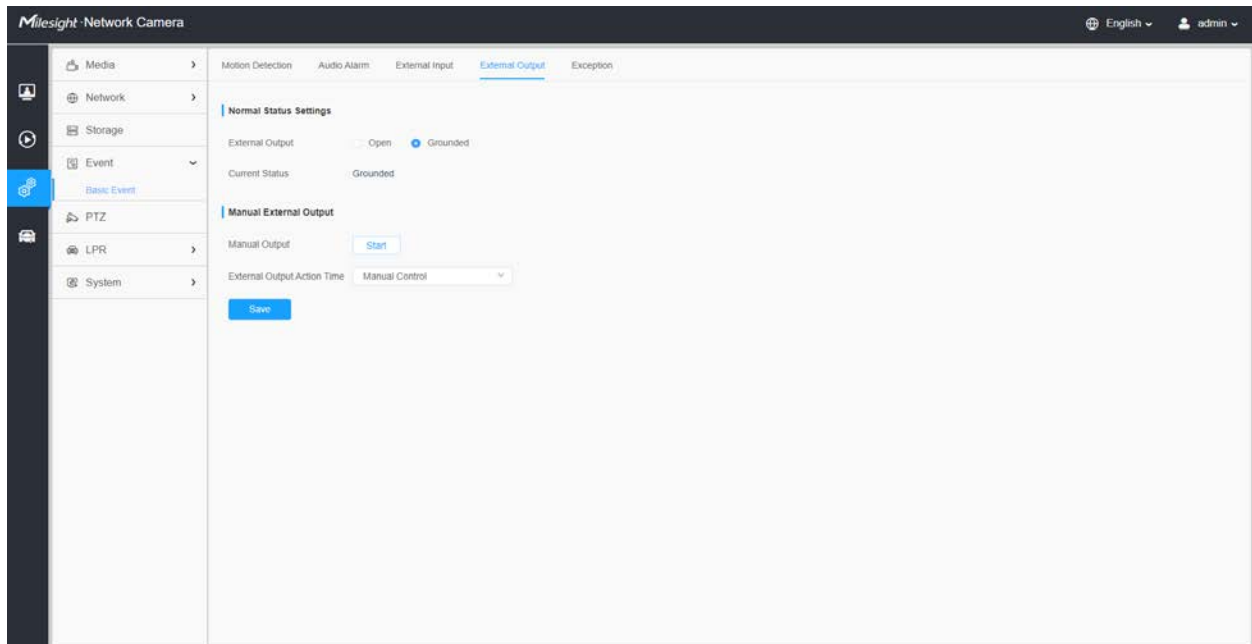

[Normal Status Settings]

Please set the **Normal Status** firstly, when the **Current Status** is different with **Normal Status**, it will lead to the alarm.

[Manual External Output]

You can set the manual external output.

Table 194. Description of the buttons

Parameters	Function Introduction
Manual Output	Click to Start/Stop manual external output.
External Output Action Time	Manual Control/Customize/10 s/1 min./5 min./10 min. are available.

Exception

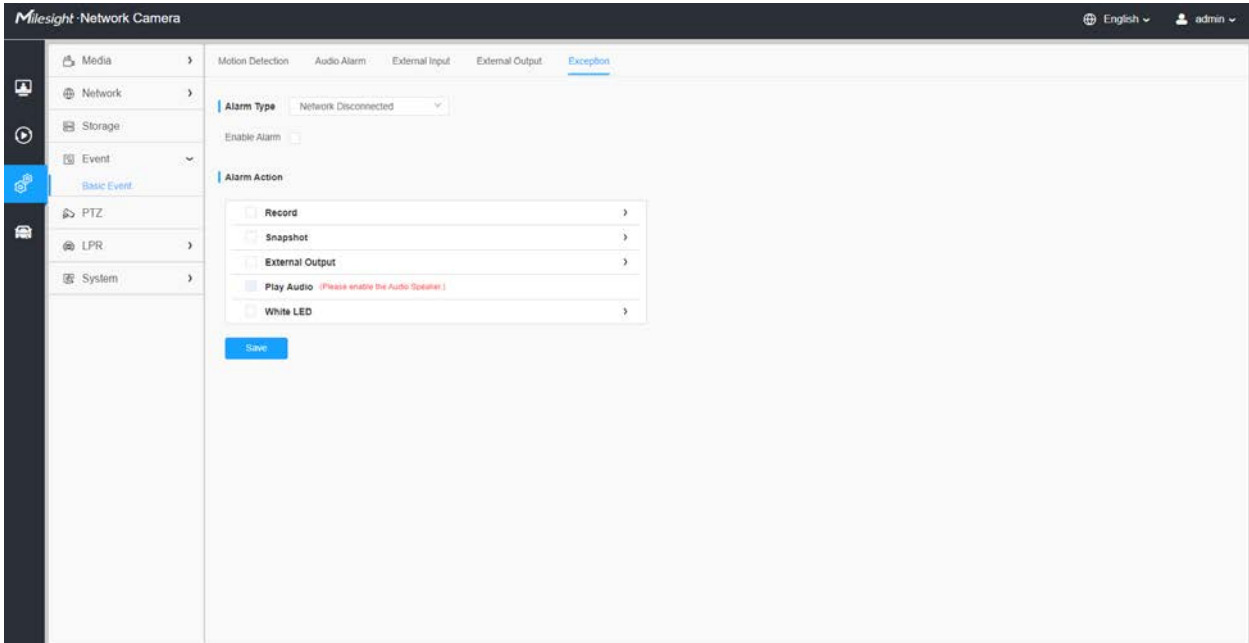

Table 195. Description of the buttons

Parameters	Function Introduction
Alarm Type	Network Disconnected, IP Address Conflicted, Record Failed, SD Card Full, SD Card Uninitialized, SD Card Error and No SD Card are available Check the checkbox to enable the alarm type you selected
Alarm Action	Refer to the table Table 3 (page 85) for the meanings of the items, here will not repeat again.

Parking Management

High-accuracy outdoor parking space detection based on AI algorithm can realize simultaneous detection and management of up to 100 parking spaces with more than

98% detection accuracy, which greatly helps guide parking and realizes more efficient and intelligent parking management.

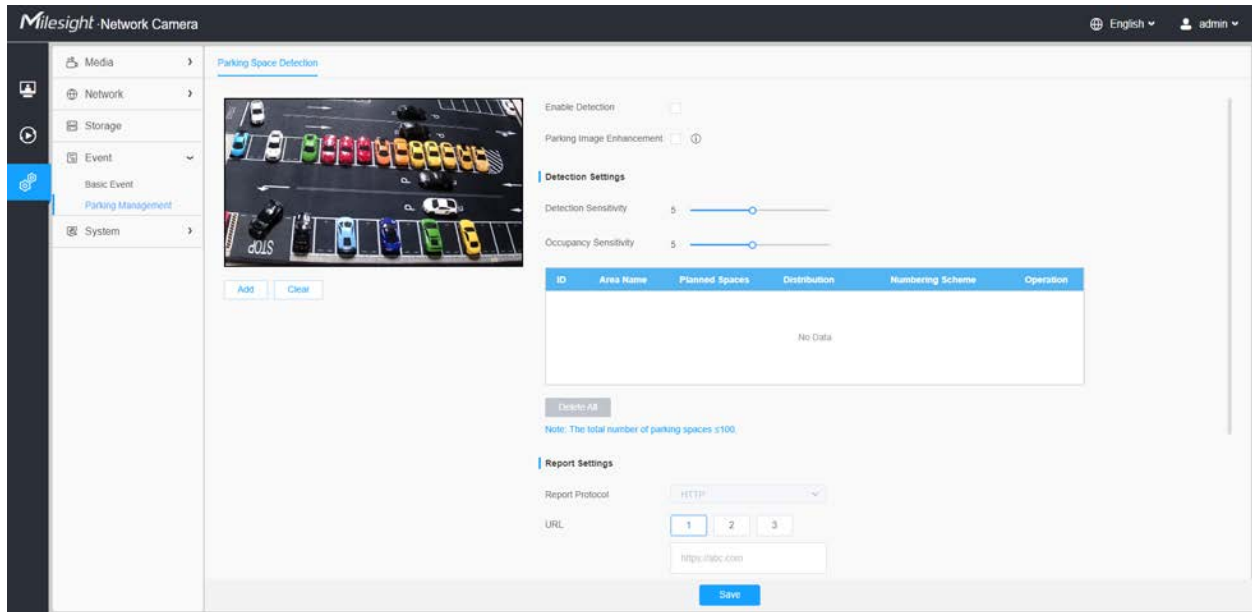

Setting steps are as shown below:

Step 1: Click the button to enable the Parking Space Detection.

Step 2: You can click the button to enable the Parking Image Enhancement, which can help to ensure the detection of parking lots at night, providing 24/7 surveillance monitoring.

Note: Custom Image Parameters may not take effect as configured while this mode enabled.

[Detection Settings]

Step 3: Set Detection Sensitivity and Occupancy Sensitivity. Level 1~10 are available, the default level is 5.

Table 196. Description of the buttons

Parameters	Function Introduction
<p>Detection Sensitivity</p>	<p>Level 1~10 are available, the default level is 5.</p> <p>The default sensitivity of 5 is the balance point between target missed detection and false detection. The higher the sensitivity, the easier the occupancy is to be detected. Users can adjust the detection sensitivity as needed to avoid some missed or false detection.</p> <p>For example, when the sensitivity is set to 10, it is possible to identify some objects that look like cars as cars, resulting in false detection.</p>

Parameters	Function Introduction
<p>Occupancy Sensitivity</p>	<p>Level 1~10 are available, the default level is 5.</p> <p>The higher the sensitivity, the parking space will be judged to be occupied if it is slightly occupied for a while; the lower the sensitivity, the parking space needs to be occupied for a certain period of time before it is judged to be occupied.</p> <p>For example, when the sensitivity is set to 10, the parking space may be judged as occupied when the vehicle passes by the parking space only briefly.</p>

Step 4: Draw the detection areas based on the parking lot. Click Add button to configure the information of detection area.

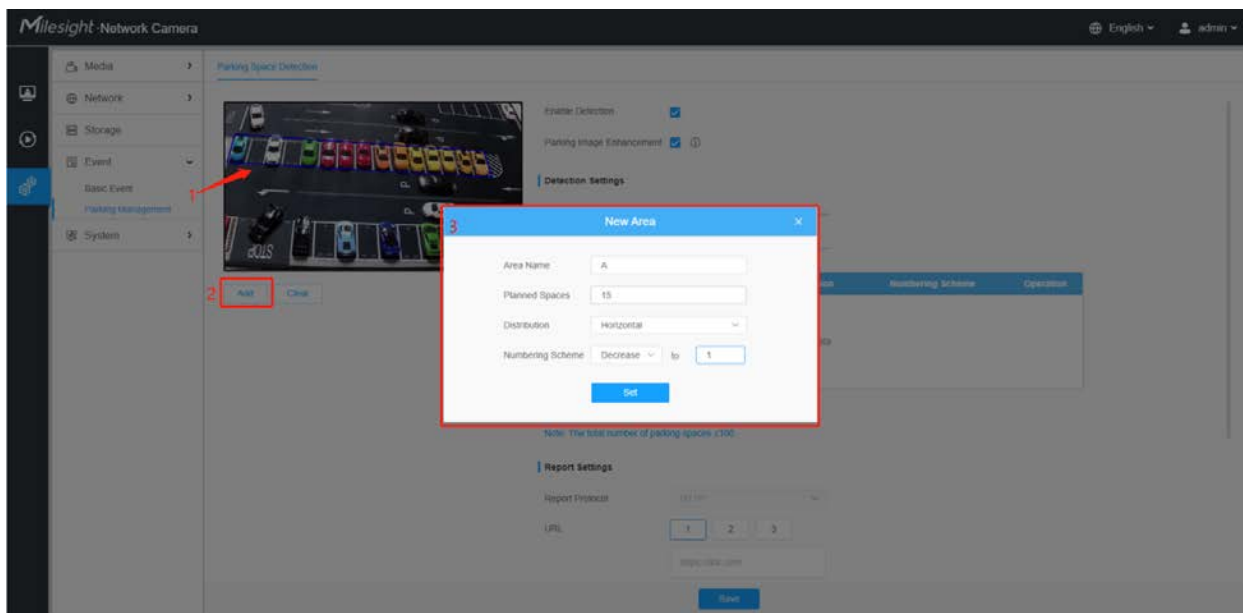

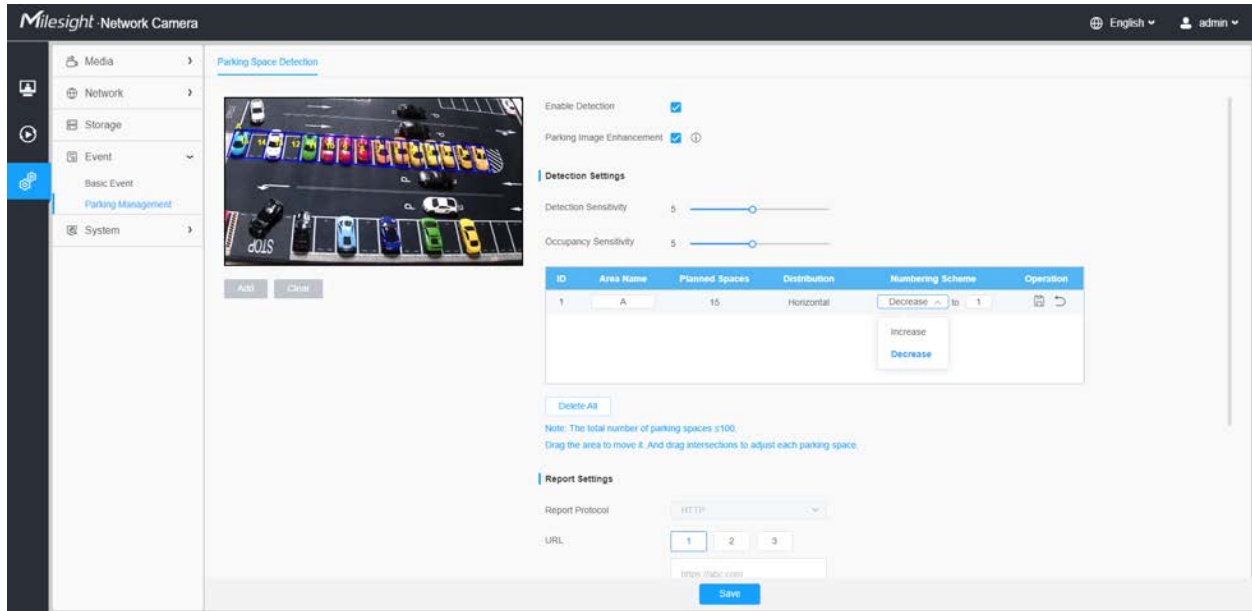





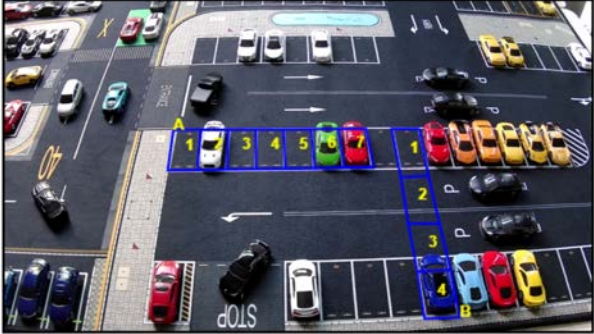

Note: The total number of parking spaces should be less than or equal to 100.

Table 197. Description of the buttons

Parameters	Function Introduction
<p>Area Name</p>	<p>The name of the detection area can be edited. Such as A1, A2, B1, B2.</p> <p>Note: Valid content: 1~10 digits or letters!</p>
<p>Planned Spaces</p>	<p>Enter the number of parking spaces on the drawn detection area. Numbers between 1~99 are available. For example, Area A has 15 planned spaces:</p> 

Parameters	Function Introduction
<p style="text-align: center;">Distribution</p>	<p>Define the distribution of parking spaces. Horizontal and Vertical are available. For example, the distribution of Area A is Horizontal, and the distribution of Area B is Vertical:</p> 
<p style="text-align: center;">Numbering Scheme</p>	<p>Define the parking space numbering scheme and the starting numbers. Increase and Decrease of numbering scheme are available, and the starting numbers between 1~99 are available. For example, the numbering scheme of Area A is Increase from 1, and the numbering scheme of Area B is Decrease to 11:</p> 
<p style="text-align: center;"></p>	<p>Edit the Area Name and Numbering Scheme of the detection area.</p>
<p style="text-align: center;"></p>	<p>Delete the detection area.</p>
<p style="text-align: center;"></p>	<p>Save the edit.</p>
<p style="text-align: center;"></p>	<p>Cancel the edit.</p>
<p style="text-align: center;">Delete All</p>	<p>Delete the all added detection areas.</p>

Step 5: You can drag the detection area to move it. And drag intersections to adjust each parking space.

 **Note:** Please click Save button to save the configuration after the adjustment.

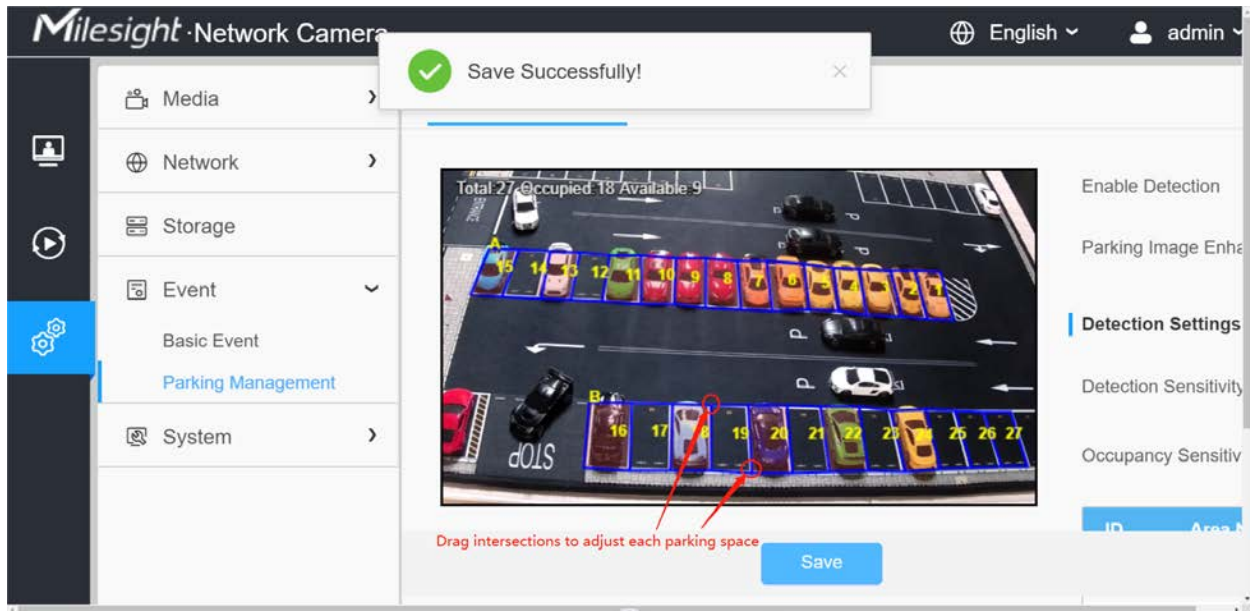

Step 6: After the configuration, the occupied parking spaces in the detection area will be covered with red to provide a more intuitive interface. And the parking information containing total number, occupied number and available number will be displayed on the interface.

Note: The minimum recognition pixel is 90*50@8MP.

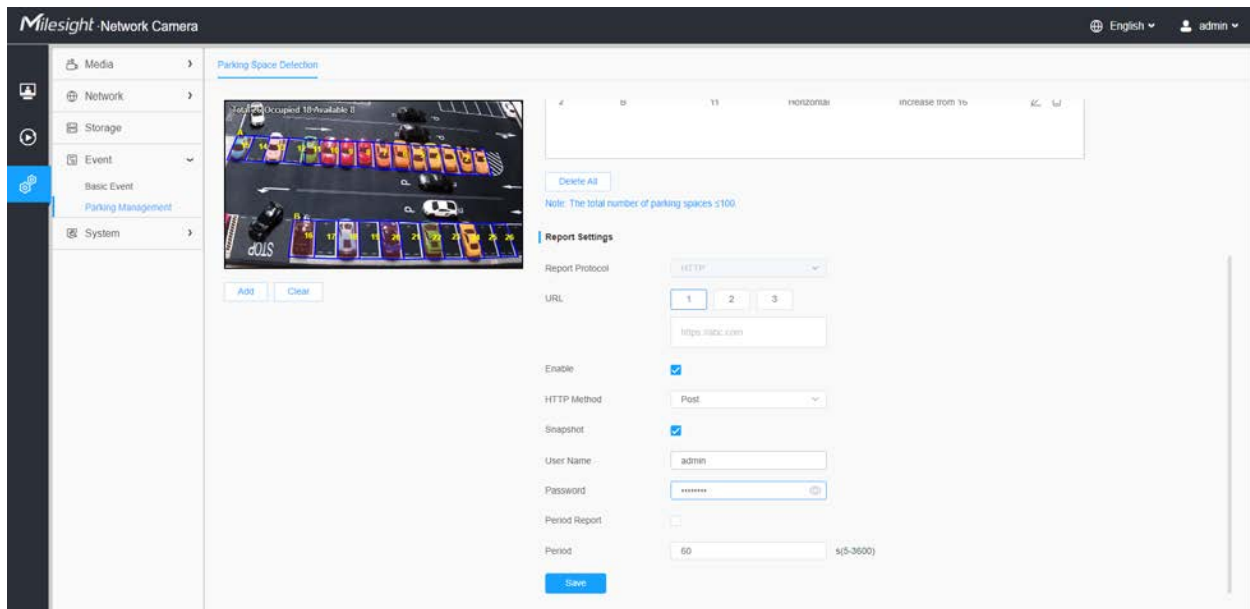

[Report Settings]

Step 7: With high compatibility, the parking information can be reported by HTTP(s).

Report Settings

Report Protocol: HTTP ▼

URL: 1 2 3
https://abc.com

Enable:

HTTP Method: Get ▼

User Name:

Password:

Periodic Report:

Period: 60 s(5-3600)

Save

Table 198. Description of the buttons

Parameters	Function Introduction
Report Protocol	Support to report the parking informations to specified HTTP URL.
URL	The HTTP URL format can be customized,for example: http://{ip}:{port}/api/httpEvent?xxxxxx
Enable	Start or stop using HTTP.
HTTP Method	There are two HTTP push methods, including Post and Get.
Snapshot	Click the button to upload the snapshots via HTTP post.  Note: This option is available just for Post HTTP Method.
User Name	Receiver name.
Password	Receiver password.
Periodic Report	According to the configured period, the parking information is pushed via HTTP post periodically.
Period	5~3600s of period time are available.

Step 8: Click the button to enable the Report.

Step 9: Click the button to enable the Periodic Report of parking space. And set the interval period time.

Periodic Report	<input checked="" type="checkbox"/>
Period	<input type="text" value="3600"/> s(5-3600)
<input type="button" value="Save"/>	

[Parking Information transfer for Post Method]

Camera will post the parking information data in JSON format in real time when it is triggered. The content will be sent is as follows:

Trigger Post

POST /post HTTP/1.1

User-Agent: httpclient

Host: 192.168.2.24:1234

Content-Type: application/json

Content-Length: 108615

```
{
  "event": "Parking Space Detection",
  "device": "Network Camera",
  "time": "2021-03-30 13:51:56",
  "report_type": "trigger",
  "resolution_w": 3840,
  "resolution_h": 2160,
  "parking_area": "A",
  "index_number": 1,
  "occupancy": 1, //1:occupied, 0:available
  "coordinate_x1": 3,
  "coordinate_y1": 220,
  "coordinate_x2": 13,
```

```

"coordinate_y2": 220,
"coordinate_x3": 3,
"coordinate_y3": 330,
"coordinate_x4": 13,
"coordinate_y4": 330,

"snapshot":
"/9j/4AAQSkZJRgABAQAAQABAAD/2wDFABALDA4MChAODQ4SERATGCgaGBY...
(Image code)"
}

```

Table 199.

Key	Sample of Value	Description
event	Parking Space Detection	The event name of the parking information data.
device	Network Camera	The Device Name which can be configured on the System Info of camera. The default is Network Camera.
time	2021-03-30 13:51:56	The time when event is triggered.
report_type	trigger	Type of parking information reported, trigger or interval.
resolution_w	3840	The width of processing resolution.
resolution_h	2160	The height of processing resolution.
parking_area index_number	A 1	The parking area name of the triggered parking space. Such as A1, A2, B1, B2.
occupancy	1	The status of parking space detection, 1 indicates occupied and 0 indicates available.
coordinate_x1 coordinate_y1	3 220	The top left coordinates of triggered parking space.
coordinate_x2 coordinate_y2	13 220	The top right coordinates of triggered parking space.
coordinate_x3 coordinate_y3	3 330	The bottom left coordinates of triggered parking space.
coordinate_x4 coordinate_y4	13 330	The bottom right coordinates of triggered parking space.

Key	Sample of Value	Description
snapshot	(Image code)	The snapshot of the event, depends on whether it is configured to send together.

Interval Post

POST /post HTTP/1.1

User-Agent: httpclient

Host: 192.168.2.24:1234

Content-Type: application/json

Content-Length: 108615

```
{
  "event": "Parking Space Detection",
  "device": "Network Camera",
  "time": "2021-03-30 13:51:56",
  "report_type": "interval",
  "total_occupied": 217,
  "total_available": 12,
  "parking_detail":
  [
    {"area_name": "A",
      "numbering_scheme": [2,3,4,5,6,7,8,9,10],
      "occupancy": [1,0,0,1,0,1,1,0,0]
    },
    {
      "area_name": "B",
      "numbering_scheme": [1,2,3,4,5,6,7,8,9],
```



```

"occupancy": [1,0,0,1,0,1,1,0,1]
},
{
"area_name": "C",
"numbering_scheme": [11,10,9,8,7,6,5,4,3],
"occupancy": [1,0,0,1,0,1,1,0,1]}
]

"snapshot":
"/9j/4AAQSkZJRgABAQAAQABAAD/2wDFABALDA4MChAODQ4SERATGCgaGBY...
(Image code)"
}

```

Table 200.

	Key	Sample of Value	Description
	event	Parking Space Detection	The event name of the parking information data.
	device	Network Camera	The Device Name which can be configured on the System Info of camera. The default is Network Camera.
	time	2021-03-30 13:51:56	The time of periodic push.
	report_type	interval	Type of parking information reported, interval or trigger.
	total_occupied	217	Total number of parking spaces occupied in the current parking space detection area.
	total_available	12	Total number of available parking spaces in the current parking space detection area.
parking_detail	area_name	A	The parking space detection area name.
	numbering_scheme	[2,3,4,5,6,7,8,9,10]	The parking space number of the current parking detection area.
	occupancy	[1,0,0,1,0,1,1,0,0]	The status of parking space detection of the current parking detection area, 1 indicates occupied and 0 indicates available.
	area_name	B	The parking space detection area name.
	numbering_scheme	[1,2,3,4,5,6,7,8,9]	The parking space number of the current parking detection area.

Key		Sample of Value	Description
	occupancy	[1,0,0,1,0,1,1,0,1]	The status of parking space detection of the current parking detection area, 1 indicates occupied and 0 indicates available.
	area_name	C	The parking space detection area name.
	numbering_scheme	[11,10,9,8,7,6,5,4,3]	The parking space number of the current parking detection area.
	occupancy	[1,0,0,1,0,1,1,0,1]	The status of parking space detection of the current parking detection area, 1 indicates occupied and 0 indicates available.
snapshot		(Image code)	The snapshot of the event, depends on whether it is configured to send together.

4.7.5 System

System Setting

Here you can check System information and Date&Time.

System info

All information about the hardware and software of the camera can be checked on this page.

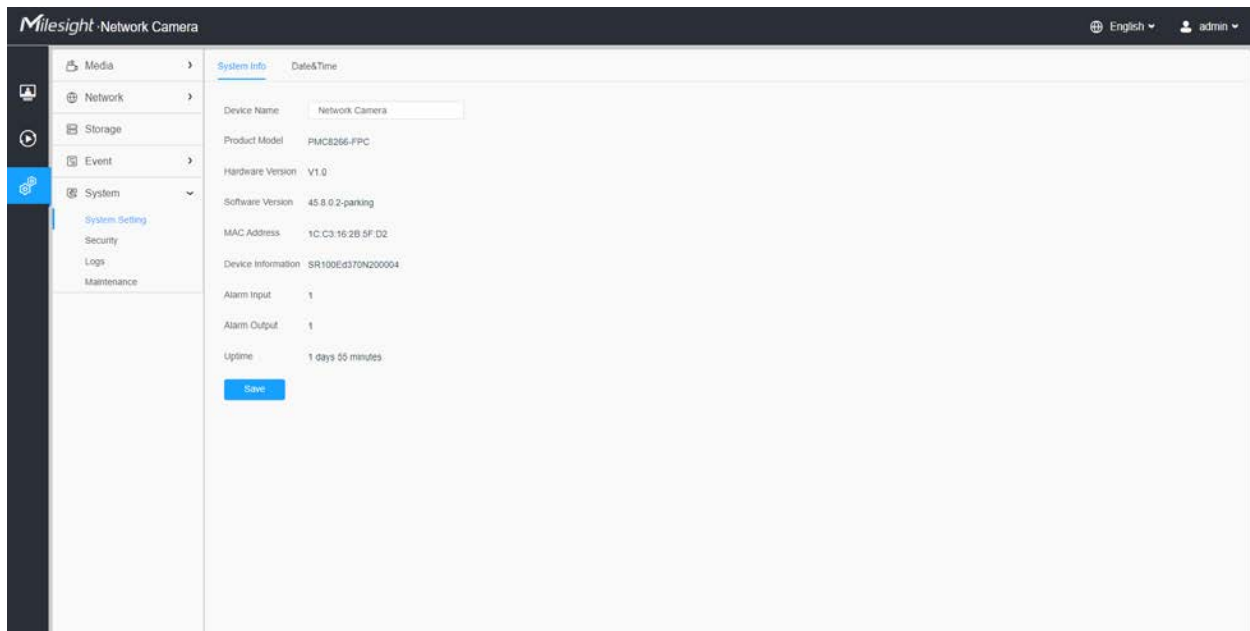

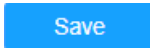

Table 201. Description of the buttons

Parameters	Function Introduction
Device Name	The device name can be customized.
Product Model	The product model of the camera.
Hardware Version	The hardware version of the camera.
Software Version	The software version of the camera can be upgraded.
MAC Address	Media Access Control address.
S/N	Stock Number.
Device Information	The device information, including information about alarm I/O and clipper chip.
Alarm Input	The number of Alarm Input interface.  Note: The Alarm Input will appear only when the camera have alarm input/output interface.
Alarm Output	The number of Alarm Output interface.  Note: The Alarm Output will appear only when the camera have alarm input/output interface.
Uptime	The elapsed time since the last restarted of the device.
	Save the configuration.

Date&Time

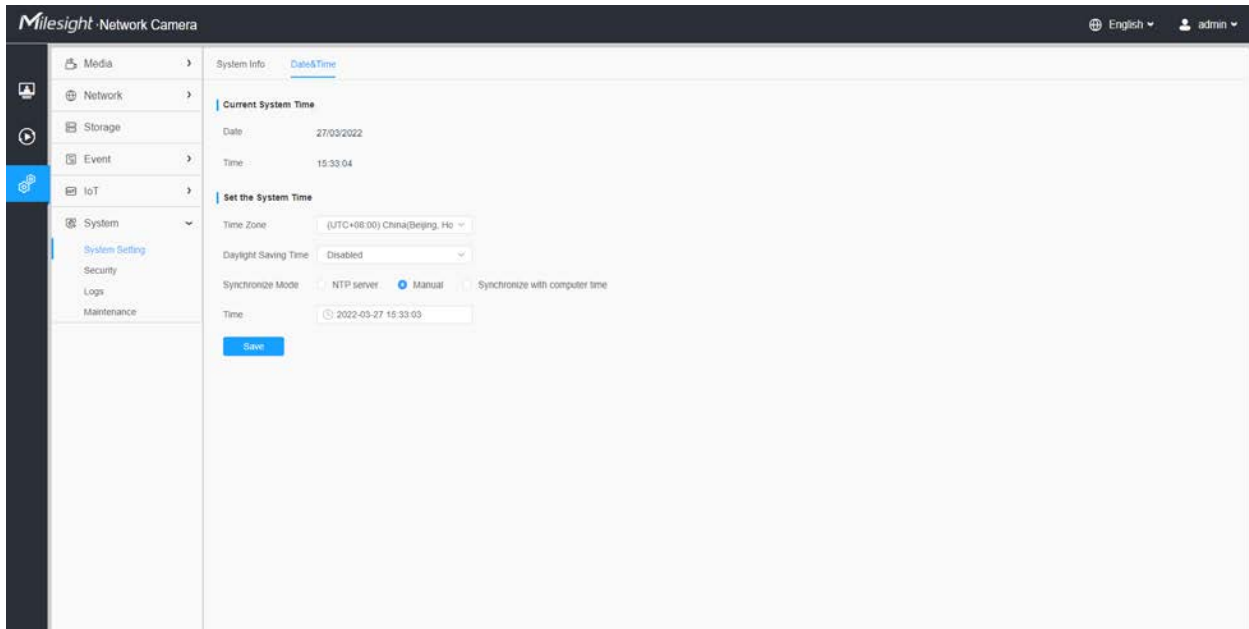

Table 202. Description of the buttons

Parameters	Function Introduction
Current System Time	Current date&time of the system.
Set the System Time	Time Zone: Choose a time zone for your location.
	Daylight Saving time: Enable the daylight saving time.
	<p>Synchronize Mode: NTP server, Manual and Synchronize with computer time are optional.</p> <p>NTP server: Input the address of NTP server.</p> <p>NTP Sync: Regularly update your time according to the interval time.</p> <p>Manual: Set the system time manually.</p> <p>Synchronize with computer time: Synchronize the time with your computer.</p>
<div style="background-color: #007bff; color: white; padding: 5px; display: inline-block; border-radius: 3px;">Save</div>	Save the configuration.

Security

Here you can configure User, Access List, Security Service, Watermark, etc.

User

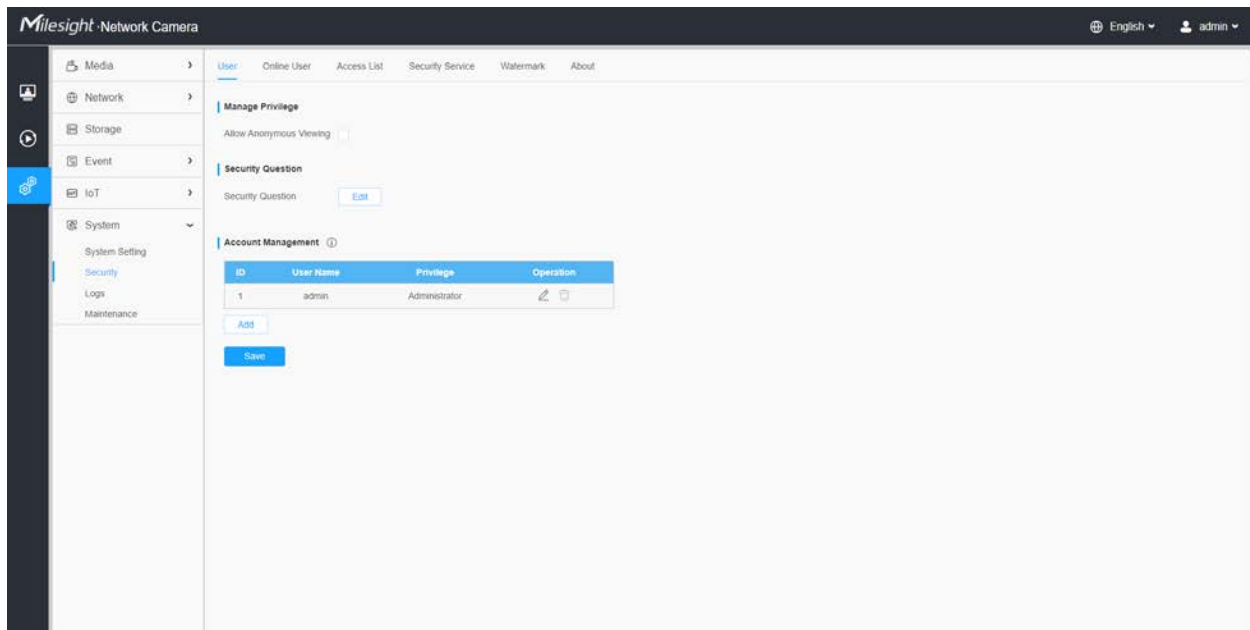



Table 203. Description of the buttons

Parameters	Function Introduction
<p>Manage Privilege</p>	<p>Allow anonymous viewing: Check the checkbox to enable visit from whom doesn't have account of the device.</p>
<p>Security Question</p>	<p>Click "Edit" button to set three security questions for your camera. In case that you forget the password, you can click "Forget Password" button on login page to reset the password by answering three security questions correctly.</p> <div data-bbox="532 525 1330 1171" style="border: 1px solid #ccc; padding: 10px; margin: 10px 0;"> <div style="background-color: #007bff; color: white; padding: 5px; display: flex; justify-content: space-between; align-items: center;"> Security Question Settings × </div> <div style="margin-top: 10px;"> <p>Admin Password* <input type="text"/></p> <p>Security Question1 What's your father's name? ▾</p> <p>Answer1* <input type="text"/></p> <p>Security Question2 What's your father's name? ▾</p> <p>Answer2* <input type="text"/></p> <p>Security Question3 What's your father's name? ▾</p> <p>Answer3* <input type="text"/></p> <div style="display: flex; justify-content: center; gap: 20px; margin-top: 10px;"> Save Cancel </div> </div> </div> <p>There are twelve default questions below, you can also customize the security questions.</p> <div data-bbox="532 1281 1330 1732" style="border: 1px solid #ccc; padding: 10px; margin: 10px 0;"> <div style="border-bottom: 1px solid #ccc; padding-bottom: 5px; display: flex; justify-content: space-between; align-items: center;"> What's your father's name? ▾ ▲ </div> <div style="display: flex; justify-content: space-between;"> <div style="width: 45%; border-right: 1px solid #ccc; padding-right: 5px;"> <p style="background-color: #007bff; color: white; padding: 2px 5px; margin: 2px 0;">What's your father's name?</p> <p style="padding: 2px 5px; margin: 2px 0;">What's your favorite sport?</p> <p style="padding: 2px 5px; margin: 2px 0;">What's your mother's name?</p> <p style="padding: 2px 5px; margin: 2px 0;">What's your mobile number?</p> <p style="padding: 2px 5px; margin: 2px 0;">What's your first pet's name?</p> <p style="padding: 2px 5px; margin: 2px 0;">What's your favorite book?</p> <p style="padding: 2px 5px; margin: 2px 0;">What's your favorite game?</p> </div> <div style="width: 45%; padding-left: 5px;"> <p style="padding: 2px 5px; margin: 2px 0;">What's your favorite food?</p> <p style="padding: 2px 5px; margin: 2px 0;">What's your lucky number?</p> <p style="padding: 2px 5px; margin: 2px 0;">What's your favorite color?</p> <p style="background-color: #e9ecef; padding: 2px 5px; margin: 2px 0;">What's your best friend's name?</p> <p style="padding: 2px 5px; margin: 2px 0;">Where did you go on your first trip?</p> <p style="padding: 2px 5px; margin: 2px 0;">Customized Question</p> </div> </div> </div>

Parameters	Function Introduction
<p style="text-align: center;">Account Management</p>	<p>Click “Add” button, it will display Account Management page. You can add an account to the camera by entering Admin Password, User Level, User Name, New Password, Confirm, and edit user privilege by clicking . The added account will be displayed in the account list.</p> <p>Admin Password: You can add an account only after you enter the correct admin password.</p> <p>User Level: Set the privilege for the account.</p> <p>User Name: Input user name for creating an account.</p> <p>New Password: Input password for the account.</p> <p>Confirm: Confirm the password.</p> <p>You can edit and delete the account in the account list under the admin account. For the default admin account, you can only change the password, and it cannot be deleted.</p> <p> Note:</p> <ul style="list-style-type: none"> • Support up to 20 users, including a default user and 19 custom added users. • The operator privilege is all checked by default.

Online User

Here real-time status of user logging in camera will be shown.

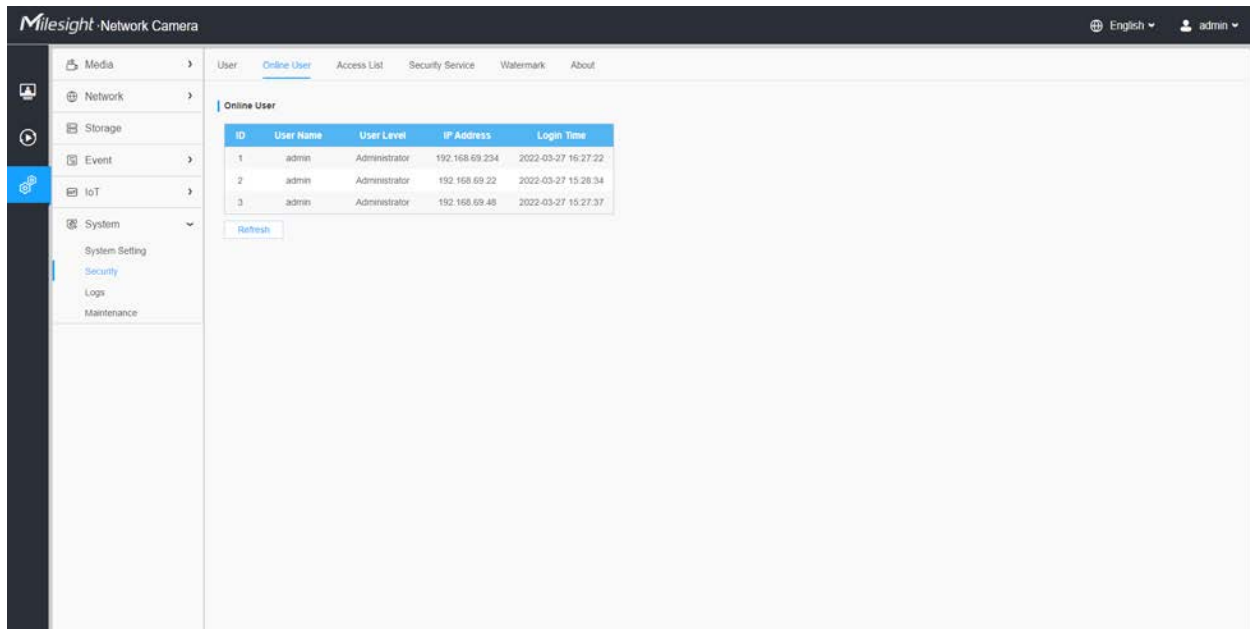



Table 204. Description of the buttons

Parameters	Function Introduction
Refresh	Click to get latest status of user accessing to camera.
ID	Record serial number of user logging in camera.  Note: <ul style="list-style-type: none"> • There are at most 30 records shown at the list. • There is only one record if the same user logs in camera by the same IP address.
User Name	Name of user logging in camera.
User Level	Level of user logging in camera.
IP Address	Device IP address where user logging in camera web located.
Login Time	Camera system time of user logging in camera.

Access List

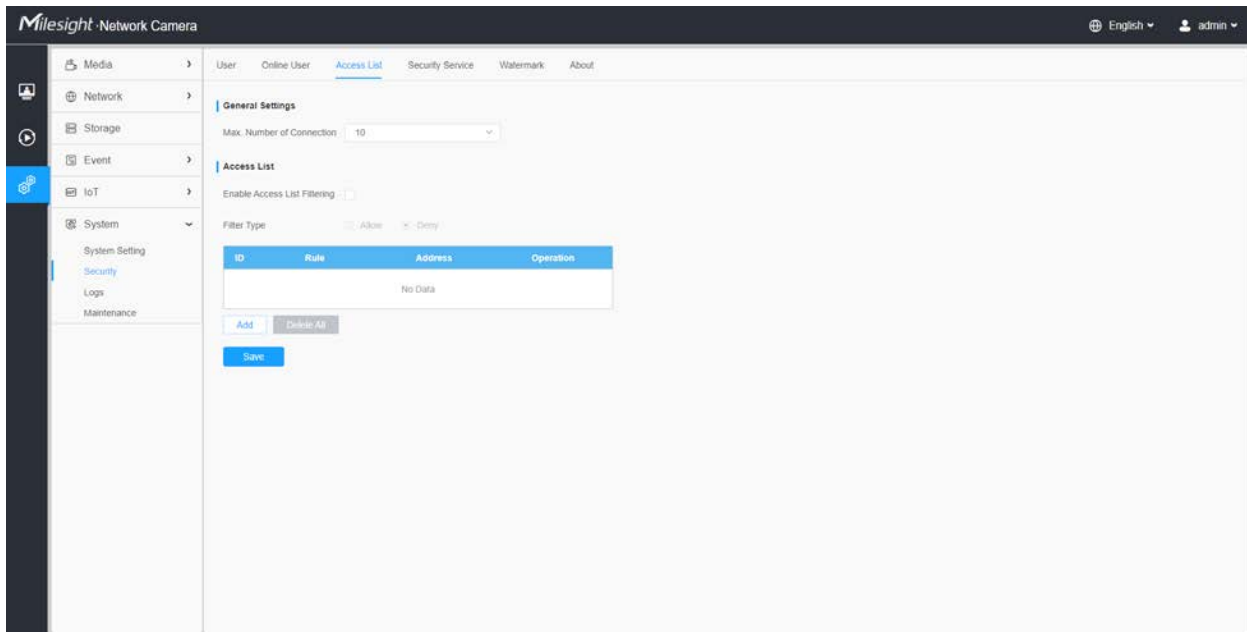
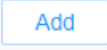
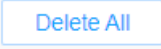





Table 205. Description of the buttons

Parameters	Function Introduction
General Settings	Max. Number of Connection: Select the maximum number of concurrent streaming. Options include No Limit, 1~10.
Access List	Enable Access List Filtering: Able to access or restrict access for some IP address.

Parameters	Function Introduction	
Access List	Filter type: Allow or deny access.	
		Rule: Single, Network and Range are available. IP address: Input the address to get the access to the device.
		Delete all the access list.
		Edit the selected IP on access list.
		Delete the selected IP on access list.
	Save the configuration.	

Security Service

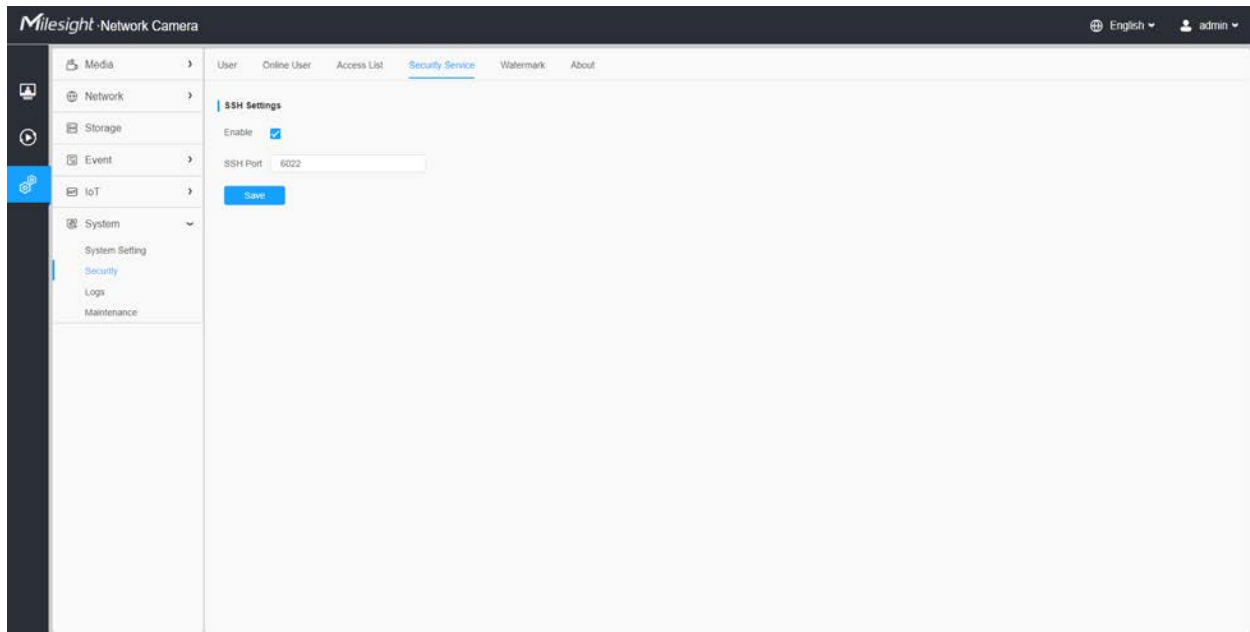
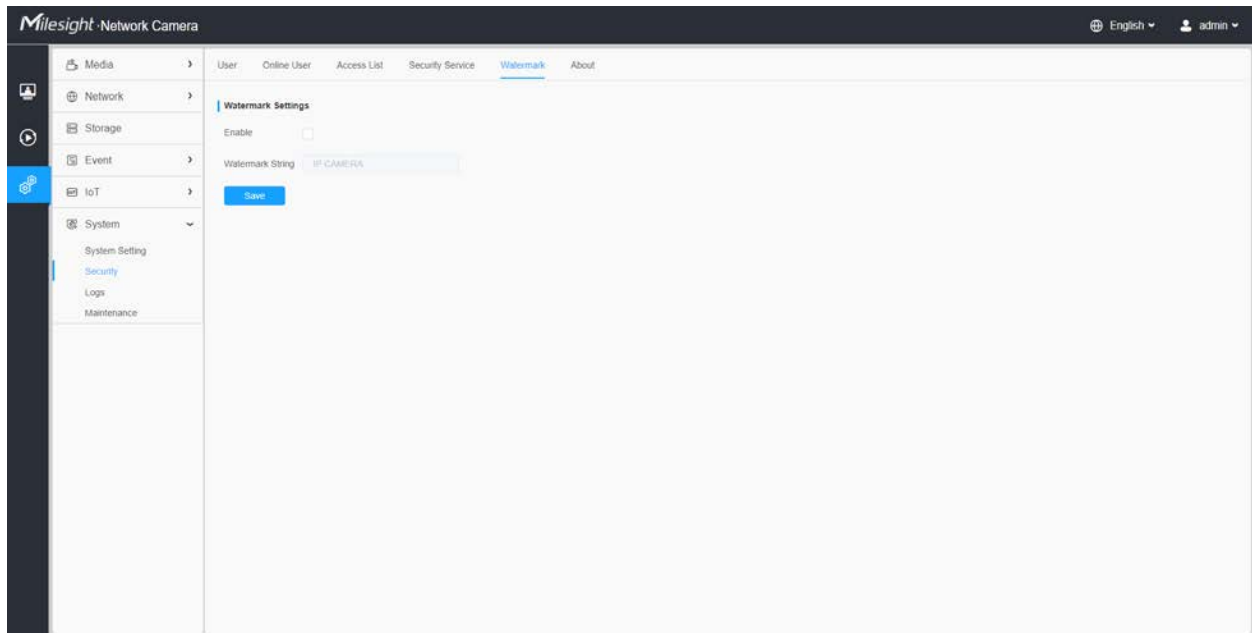

Table 206. Description of the buttons

Parameters	Function Introduction
SSH Settings	Secure Shell (SSH) has many functions: it can replace Telnet and also provides a secure channel for FTP, POP, even for PPP.

Watermark



Watermarking is an effective method to protect information security, realizing anti-counterfeiting traceability and copyright protection. Milesight Network cameras supports Watermark function to ensure information security.

About

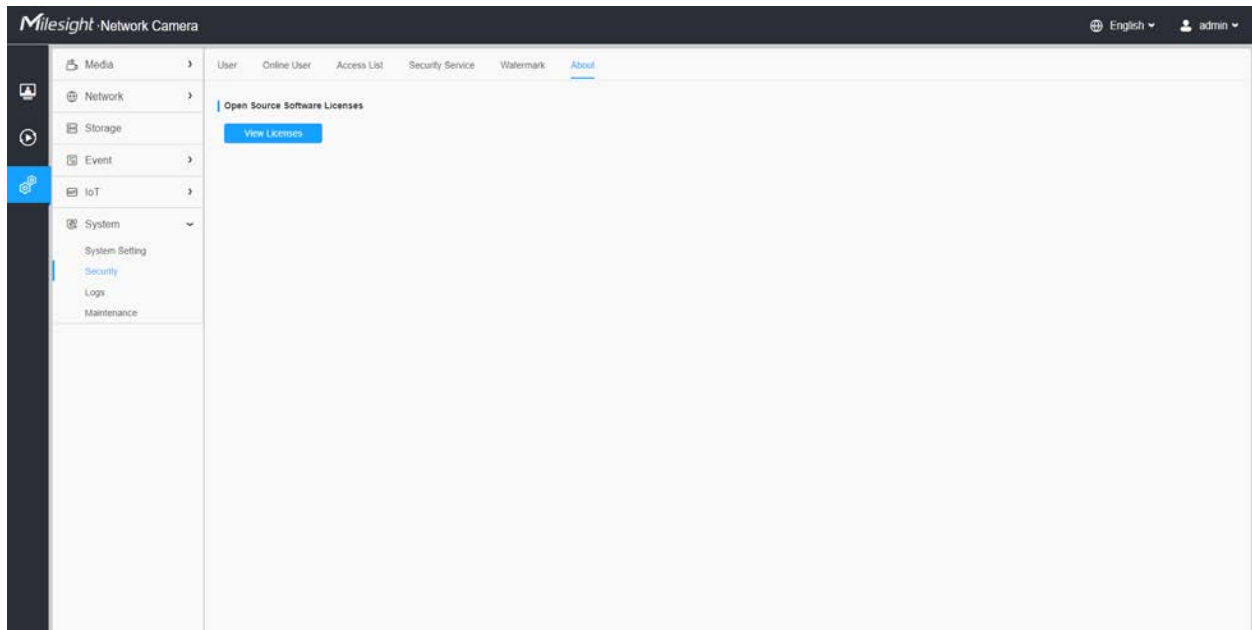

User can view some open source software licenses about the camera by clicking the View Licenses button.

Logs

The logs contain the information about the time and IP that has accessed the camera through web.

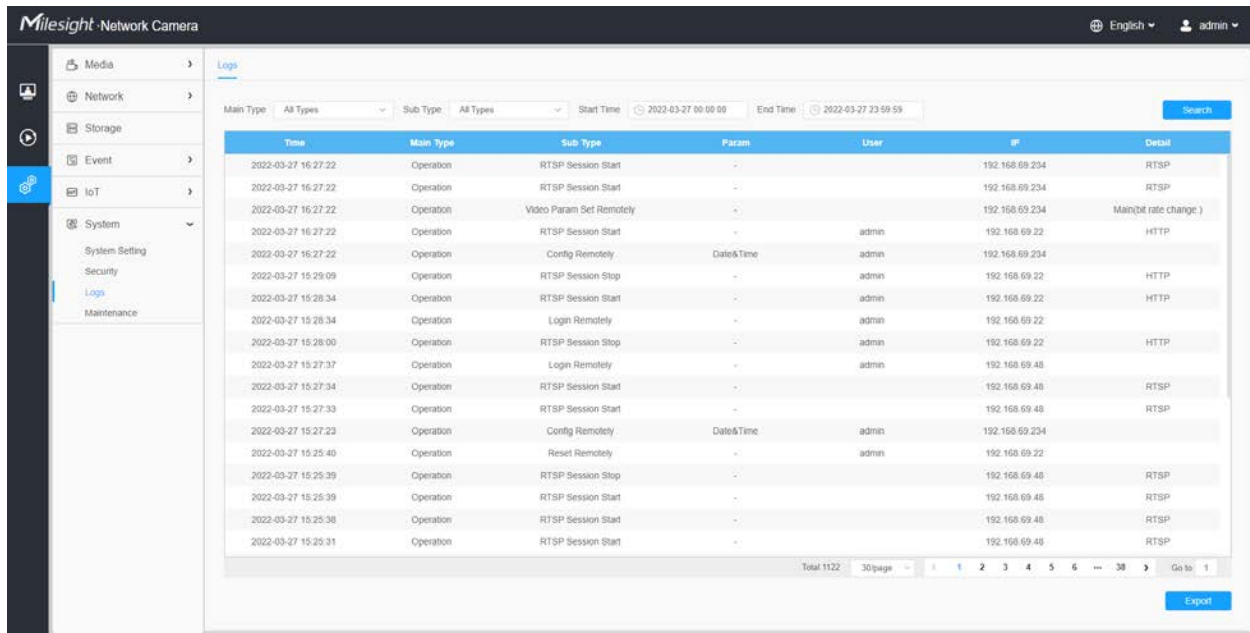
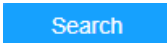



Table 207. Description of the buttons

Parameters	Function Introduction
Main Type	There are five main log types: All Type , Event , Operation , Information , Exception and Smart .
Sub Type	On the premise that main type has been selected, select the sub type to narrow the range of logs.
Start Time	The time log starts.
End Time	The time log ends.
	Search the logs.
	Export the logs.

Parameters	Function Introduction
Go to	Input the number of logs' page.

Maintenance

Here you can configure System Maintenance and Auto Reboot.

System Maintenance

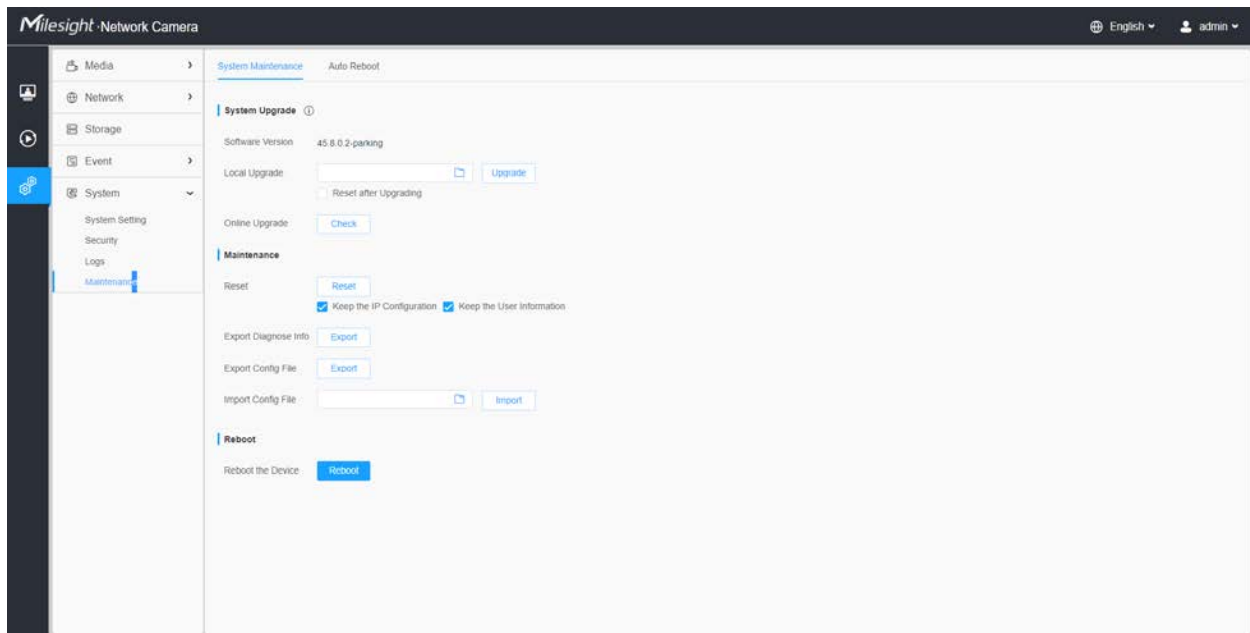



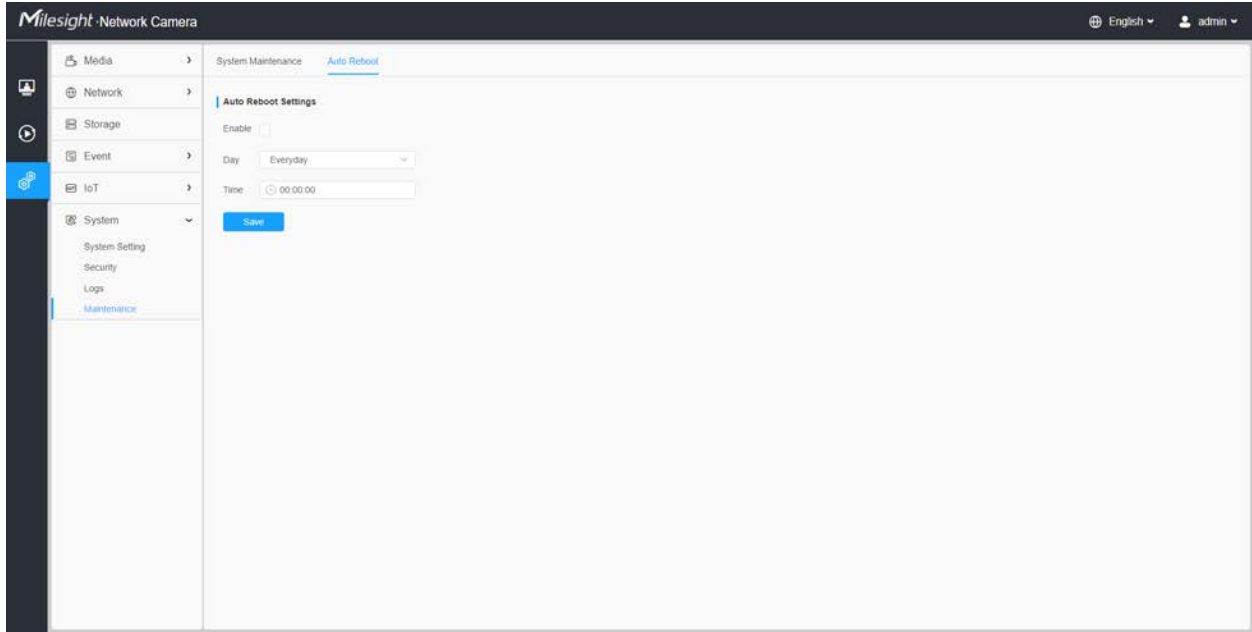

Table 208. Description of the buttons

Parameters	Function Introduction
<p style="text-align: center;">System Upgrade</p>	<p>Software Version: The software version of the camera.</p> <p>Local Upgrade: Click the "Browse" button and select the upgrading file, then click the "Upgrade" button to upgrade. After the system reboots successfully, the update is done.</p> <p>You can check "Reset after Upgrading" to reset the camera after upgrading it.</p> <p>Online Upgrade: Click the "Check" button to check the current latest firmware version on our website, and then click "OK" to upgrade to this version.</p> <p>It will prompt "The current version is the latest version" if your camera is already the latest version.</p> <div style="border: 1px solid #00aaff; background-color: #00aaff; color: white; padding: 5px; text-align: center; margin: 10px 0;"> × Tips </div> <div style="text-align: center; margin: 10px 0;">  The current version is the latest version. </div> <div style="text-align: center; margin: 10px 0;"> OK </div> <p> Note: Do not disconnect the power of the device during the update. The device will be restarted to complete the upgrading.</p>

Parameters	Function Introduction
<p style="text-align: center;">Maintenance</p>	<p>Reset: Click "Reset" button to reset the camera to factory default settings.</p> <p>Keep the IP Configuration: Check this option to keep the IP configuration when resetting the camera.</p> <p>Keep the User information: Check this option to keep the user information when resetting the camera.</p> <p>Export Diagnose Info: Click this button to export logs and system information of the device operation status.</p> <p> Note: The file format is ".txt".</p> <p>Export Config File: Click this button and a window will pop up as shown below:</p> <div data-bbox="592 735 1388 1060" style="border: 1px solid #ccc; padding: 10px; background-color: #f9f9f9;"> <div style="background-color: #0070c0; color: white; padding: 5px; display: flex; justify-content: space-between; align-items: center;"> File Encryption Configuration × </div> <div style="padding: 10px;"> <p>Input the encryption password <input style="width: 100%;" type="text"/></p> <p>Confirm <input style="width: 100%;" type="text"/></p> <div style="display: flex; justify-content: center; gap: 20px; margin-top: 10px;"> Save Cancel </div> </div> </div> <p>You need to enter and confirm password again, then click save button to export configuration file.</p> <p>Import Config File: Click this button, then a window will pop up and you can click "OK" to update the configuration.</p> <p>It will pop up a window to prompt "Input the password of config file" , then enter password and click save button to import configuration file.</p> <div data-bbox="592 1333 1388 1585" style="border: 1px solid #ccc; padding: 10px; background-color: #f9f9f9;"> <div style="background-color: #0070c0; color: white; padding: 5px; display: flex; justify-content: space-between; align-items: center;"> File Encryption Configuration × </div> <div style="padding: 10px;"> <p>Input the encryption password <input style="width: 100%;" type="text"/></p> <div style="display: flex; justify-content: center; gap: 20px; margin-top: 10px;"> Save Cancel </div> </div> </div> <p> Note:</p> <p>Export and import the same configuration file. Password must be the same.</p>

Auto Reboot



Set the date and time to enable Auto Reboot function, the camera will reboot automatically according to the customized time in case that camera overload after running a long time.

Chapter 5. Services

Milesight provides customers with timely and comprehensive technical support services. End-users can contact your local dealer to obtain technical support. Distributors and resellers can contact directly with Milesight for technical support.

Technical Support Mailbox: support@milesight.com

Web: <http://www.milesight.com>

Online Problem Submission System: <http://www.milesight.com/service/feedback.asp>

MILESIGHT USA

TEL: +1-800-561-0485

Add: 220 NE 51st ST, Oakland Park, Florida 33334, USA

MILESIGHT KOREA

TEL: +82-2-839-3335

Add: 925, Anyang SK V1 Center, LS-ro 116beon-gil, Dongan-gu, Anyang-si, Korea

MILESIGHT CHINA

TEL: +86-592-5922772

Add: Building C09, Software Park Phase III, Xiamen 361024, Fujian, China