

**Clamp "D" for flat vehicle keys - Morsetto "D" per chiavi piatte veicoli
Spannbacke "D" für Auto-Flachschlüssel - Etai "D" pour clés plates véhicules
Mordaza "D" para llaves planas vehículos - Mordente "D" para chaves planas veículos**

PER:
FOR:

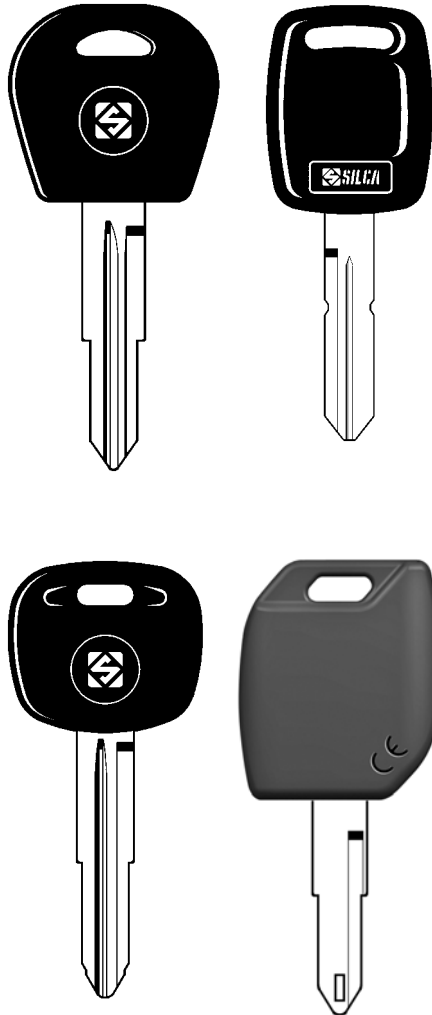

Over 368 profiles available of vehicle keys.
Oltre 368 profili disponibili di chiavi per veicoli.
Über 368 verfügbare von Auto-Schlüssel Profile.
Plus de 368 profils disponibles de clés pour véhicules.
Más de 368 perfiles disponibles de llaves para vehículos.
Mais de 368 perfis disponíveis das chaves para veículos.

D740050ZB

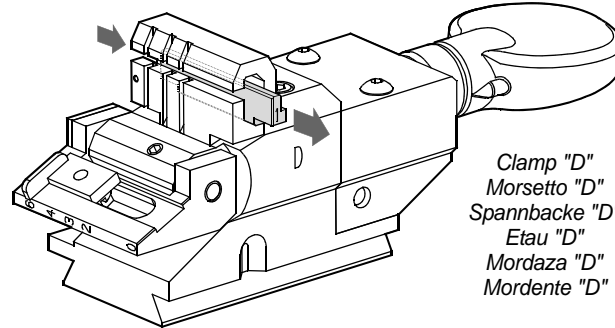

Clamp "D"
Morsetto "D"
Spannbacke "D"
Etai "D"
Mordaza "D"
Mordente "D"

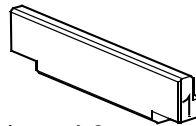

Insert 1-2
Inserto 1-2
Einsatz 1-2
Insert 1-2
Inserto 1-2
Peça 1-2

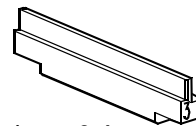

Insert 3-4
Inserto 3-4
Einsatz 3-4
Insert 3-4
Inserto 3-4
Peça 3-4

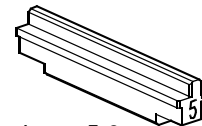

Insert 5-6
Inserto 5-6
Einsatz 5-6
Insert 5-6
Inserto 5-6
Peça 5-6



U113

Tracer point
Tastatore
Taster
Palpeur
Palpador
Palpador



U113DC

Decoder for vehicle keys
Decodificatore per chiavi veicoli
Decoder für Auto-Schlüssel
Décodateur pour clés véhicules
Descodificador para llaves vehículos
Descodificador chaves veículos



H158

Cutter
Fresino
Fräser
Fraise
Fresa
Fresa

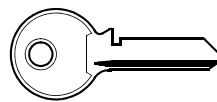

Z3

Template for calibration
Dima di taratura
Eichschablone
Gabarit pour étalonnage
Escantillon de ajuste
Gabarito para ajuste



CD Wintransfer

- Clamp "D" can only be used on VIPER machines with SW version 1.2.018 DB 9.00 or later.
- Il morsetto "D" può essere utilizzato solo con duplicatrici VIPER aventi versione SW 1.2.018 DB 9.0 o superiore
- Die Spannbacke "D" kann nur mit Schlüsselkopiermaschinen VIPER mit SW-Version 1.2.018 DB 9.0 oder höher verwendet werden.
- L'étai "D" ne peut être utilisé que sur des duplicatrices VIPER dotées de la version SW 1.2.018 DB 9.0 ou postérieure.
- La mordaza "D" puede ser utilizada solo con duplicadoras VIPER con la versión SW 1.2.018 DB 9.0 o superior.
- O mordente "D" pode ser utilizado exclusivamente com máquinas duplicadoras VIPER com versão de SW 1.2.018 DB 9.0 ou superior.

PER:
FOR:

RENAULT (F)

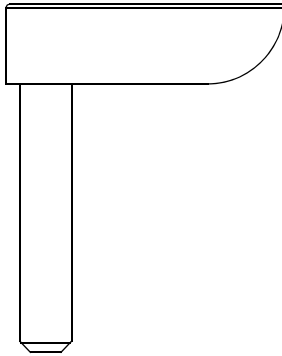

VALEO (F)

OPTIONAL



D736123B

Adapter I1 for Renault keys
Adattatore I1 per chiavi Renault
Adapter I1 für Renault Schlüssel
Adaptateur I1 pour clés Renault
Adaptador I1 para llaves Renault
Adaptador I1 para chaves Renault

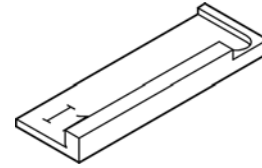

STANDARD



D709238ZB

Cutter W101 (carbide)
Fresa W101 (metallo duro)
Fräser W101 (Hartmetall)
Fraise W101 (au carbure)
Fresa W101 (metal duro)
Fresa W101 (metal duro)

PER:
FOR:

ZADI (I)

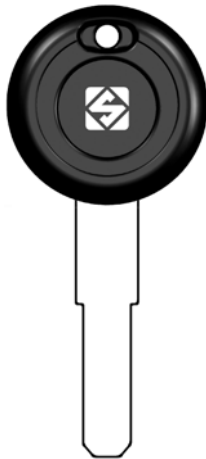

ZD30T5

OPTIONAL



D738443ZB

Adapter I2 for ZD30T5 keys
Adattatore I2 per chiavi ZD30T5
Adapter I2 für ZD30T5 Schlüssel
Adaptateur I2 pour clés ZD30T5
Adaptador I2 para llaves ZD30T5
Adaptador I2 para chaves ZD30T5

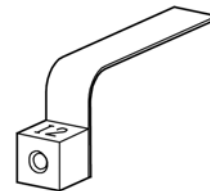

OPTIONAL



D709481ZB

Cutter H114 (HSS)
Fresa H114 (HSS)
Fräser H114 (HSS)
Fraise H114 (HSS)
Fresa H114 (HSS)
Fresa H114 (HSS)

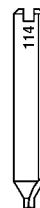

D709482ZB

Cutter W114 (carbide)
Fresa W114 (metallo duro)
Fräser W114 (Hartmetall)
Fraise W114 (au carbure)
Fresa W114 (metal duro)
Fresa W114 (metal duro)